

REPORT ON THE CORVETTE

POPULAR MECHANIC

MAGAZINE

WRITTEN SO YOU CAN

REG'D TRADE MARK, GREAT BRITAIN, No. 40426

OCTOBER 1954

35 CENTS

**Special! Giant
Home Section**

50 Pages All About Houses . . . An
Album of \$7,000 to \$15,000 Homes
. . . Space Savers for Heating and
Cooling . . . Remodeling Ideas
. . . Hundreds of Practical Tips

BIG EXTRA do-it-yourself section

*The House Our Readers Asked For
—Page 145*



THERE IS NO LONGER ANY EXCUSE FOR NOISY OUTBOARD MOTORING



FOR 1955

FOUR "SUSPENSION DRIVE" SEA-HORSES!

Here are America's *deluxe* outboard motors—the quietest running, easiest driving, smoothest riding Sea-Horses ever developed! The *new* Sea-Horse 10, the *new* Sea-Horse 25 and the *new* Electric Starting 25 are floated from their stern brackets like the Sea-Horse 5½, which created a sensation with its smoothness and its quiet. *That's Suspension Drive!* It isolates your boat from engine vibration as no other method of mounting can. Engine throb is absorbed—noise is dissipated—and you experience the thrill of big motor speed with amazing new quiet and comfort . . . See your Johnson Dealer. Look for his name under "Outboard Motors" in your classified phone book.

FREE! New Sea-Horse Catalog. Describes the 5 great Sea-Horses for 1955, including the famous 3 hp. 32 lb. twin Sea-Horse 3. Write for your copy.

JOHNSON MOTORS, 400 Pershing Rd., Waukegan, Ill.
In Canada: Mfd. by Johnson Motors, Peterborough



QUIET 25
Electric Starting
\$525.00

QUIET 25
\$430.00

QUIET 10
\$310.00

QUIET 5½
\$210.00

Prices f.o.b. factory. Subject to change without notice.

Johnson
SEA-HORSES
FOR **DEPENDABILITY**



*"First thing I knew -
I was in a corner!"*

**Never
needs
waxing!**

YEP, before I knew it—there it was. A beautiful new floor of Goodyear All-Vinyl—completely installed, *by me!*

You see I couldn't resist tackling it after my husband got the old floor all ready for covering. The handy installation kit and instructions provided by Goodyear made it look so easy—and it *was!*

On went the adhesive with the trowel, down went the tiles just as pretty as you please.

How proud I was. It looked so wonderful—and believe me: the service it has given me has *proved* Goodyear All-Vinyl Flooring is as good as it looks!

Know why? The tiles are *pre-polished* at the factory—make a lastingly lovely floor that *never needs waxing*.

WRITE FOR FREE BOOKLET — Full-color illustrations and full facts on home installation of famed Goodyear All-Vinyl Flooring! Simply address a post card to:
Goodyear, Flooring Dept. V-8318, Akron 16, Ohio.



Do it yourself!

Handy FLOR-MASTER INSTALLATION KIT provides all the tools and instructions needed to do a professional flooring job in jig time. Available at better dealers' everywhere—where Goodyear All-Vinyl Flooring is sure to be a featured item!

Flor-Master—T.M. The Goodyear Tire & Rubber Company, Akron, Ohio

GOOD YEAR *All-Vinyl* Flooring

FOR FLOORS • WALLS • COUNTER TOPS — BY THE TILE OR YARD

This One

OCTOBER 1954



DXL4-Z9J-SPZ4

1

lighted material

CHAMPION SETS GREATEST PERFORMANCE RECORD IN SPARK PLUG HISTORY!

IN THE 1954 INDIANAPOLIS RACE,
every one of the 33 starting cars qualified and ran on Champions in the fastest "500" of all time.
QUALIFYING RECORD 141.033 MPH — 500-MILE RECORD 130.840 MPH
But more important to your motoring pleasure is this great record confirmed by the AAA Contest Board supervising the "500"—

**NOT ONE CHAMPION SPARK PLUG WAS
REPLACED DURING THE ENTIRE RACE!**

Here is spark plug quality, performance and dependability obtainable only from famous 5-rib Champions. Better see your service station or garage and have America's favorite spark plugs put in *your* car. You'll be proud of your judgment!

CHAMPION SPARK PLUG COMPANY, TOLEDO 1, OHIO



Specify-

CHAMPIONS

WITH THE PATENTED 5-RIB INSULATOR!

VUKOVICH PASSES BRYAN. In a sustained drive, Vukovich moved from 19th place starting position to 1st place and a record 130.840 MPH victory. Bryan drove a tremendous race to 2nd place at 130.178 MPH.

Popular Mechanics Magazine

Registered in U. S. Patent Office and Canada

H. H. WINDSOR, Founder

H. H. WINDSOR, JR., Editor and Publisher

Volume 102

OCTOBER 1954

Number 4

Address all communications to: 200 E. Ontario St., Chicago 11, Ill.

Managing Editor.....	Roderick M. Grant
Assistant Managing Editor.....	Wayne Whittaker
Shop Notes and Crafts Editor.....	James R. Ward
Radio-Television, Electronics Editor.....	Frank L. Brittin
Associate Editor.....	Clifford B. Hicks
Associate Editor, Automotive.....	Arthur R. Railton
Associate Editor.....	George E. Moise
Associate Editor, Shop Notes and Crafts.....	Wayne C. Lemkey
Assistant Editor, Shop Notes.....	W. Clyde Lemmy
Assistant Editor, Crafts.....	Frank N. Stephany
Assistant Editor, Make-up.....	John C. Dalen
Automotive Correspondent.....	Leo Donovan
Art Director.....	Frank Beatty
Assistant Editors: Leonard F. Hilts, Jay W. Hedden, Elliott H. McCleary	
Eastern Editor.....	Richard F. Dempewolf
Empire State Bldg., Room 2906, New York City 1	
Western Editor.....	Thomas E. Stimson, Jr.
Suite 1010, 3460 Wilshire Blvd., Los Angeles 5, Calif.	
London Manager.....	Douglas W. Wedderspoon
Eagle House, Jermyn St., London S. W. 1, England	
Director, Bureau of Information.....	Allan Carpenter
200 E. Ontario St., Chicago 11	



this month's cover

WHEN ARCHITECT Rudolph A. Matern submitted his preliminary sketches and floor plans for "The House You Asked For" he included a rough drawing showing the outdoor-living area of the home. "This might not be a bad angle for the cover," wrote Matern. "What do you think?" We thought it looked pretty sharp and so did Robert Korta, staff illustrator, who did the finished painting you see on the cover. That tree you see in the patio across from the glassed-in breakfast area of the kitchen is actually growing near the Korta home in Hinsdale, Ill. For a full-color treatment of this house and the story behind it turn to page 145

Information not listed on articles in the index, starting on page 12, frequently is listed in the WHERE-TO-FIND-IT LIST, which is available to readers without charge. A copy may be obtained by writing to the Bureau of Information, Popular Mechanics, 200 E. Ontario, Chicago 11, Ill.

In This Issue . . .

Monsters on Parade - - - - -	97
Buffalo, Cattle and now Oil - - - - -	106
The Owners Report on the Corvette - - - - -	118
Don't Get Lost in the Wilderness - - - - -	130
Swamp-Buggy Steeplechase - - - - -	136
Special Housing Section—	
The House You Asked For - - - - -	145
At Home, 2004 A.D. - - - - -	154
Parade of Homes — \$7,250 to \$15,000 - - - - -	157
Would You Build It Yourself Again? - - - - -	162
Is the Old Homestead Worth Remodeling? - - - - -	173
Modernize Your Home With Translucent Panels - - - - -	181
New Faces for Old Homes - - - - -	190

For the Craftsman . . .

Free-Form Table of Cork - - - - -	195
Folding Home Workshop - - - - -	206
How to Install a Vent Fan in Your Kitchen - - - - -	213
Your Car Battery — How It Works - - - - -	218
Indexing Attachment for Your Lathe - - - - -	223
Cove Cutting on the Circular Saw - - - - -	228
Selecting and Using a Bench Vise - - - - -	233
Rivet It Right - - - - -	238
Shopping for Tools - - - - -	242
Radio, TV and Electronics - - - - -	245

Other items and manufacturers of available products described are listed on pages 18, 24 and 26

Published monthly by Popular Mechanics Company, 200 E. Ontario St., Chicago 11, Ill. H. H. Windsor, Jr., president; Wm. Harrison Petridge, exec. vice-pres.; D. F. Windsor, vice-president and secretary-treasurer; H. H. Windsor III, vice-president; Clover L. Perkins, advertising manager; Alan M. Deyoe, circulation manager. Single copy in the United States and Canada, 35 cents; subscription rates in the United States and possessions, Canada, Philippines and countries of the Pan-American Postal Union, 1 year \$3.50; 2 years, \$6.00; 3 years \$8.00. To all other countries add \$1.00 a year over United States prices for overseas postage. If you plan to move, notify us at least 30 days in advance so you will not miss an issue. Give both your old and new addresses. Entered as Second Class Matter, September 15, 1903, at the Post Office at Chicago, Illinois, under Act of March 3, 1879. Entered as Second Class Matter at Post Office Dept., Canada. Registered as Second Class Matter at the Post Office at Mexico, D. F., Mexico, June 20, 1950. Copyright 1954 by Popular Mechanics Company. Copyright under International Copyright Union. Copyright in France. All rights reserved under Pan-American Copyright Act. Printed in the United States of America.



The new
Ford THUNDERBIRD

—masterpiece of engineering

A new kind of personal car that combines sports-car styling and performance with passenger-car conveniences

If you've seen this sleek-looking number on the road, chances are you haven't forgotten it. A mere 34.2 inches from door top to tread, with a 102-inch wheelbase, this all-American-built personal car is already influencing future automobile design. And appearance is only half the story. Beneath the Thunderbird's beautiful all-steel body you'll find fresh new features. For example, the Thunderbird's

steering wheel telescopes in or out a full three inches. The Astra-Dial Control Panel includes a tachometer, signal lights for oil and generator, and a clock with sweep second hand. The Thunderbird answers to the controls with nimble responsiveness that is wonderful to experience.

Power steering, power brakes, power windows and a 4-way power seat are available.

OPTIONAL HARD TOP CAN BE QUICKLY REMOVED . . .



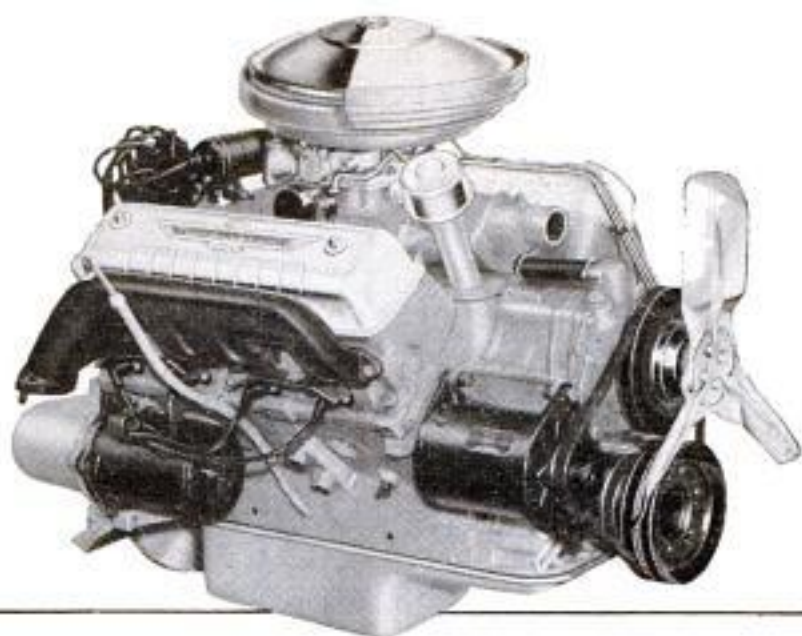

POWERED BY THIS HIGH-TORQUE THUNDERBIRD SPECIAL V-8

The brilliant new Thunderbird Special is an advanced form of Ford's famous Y-block V-8 engine. It has an 8.1 to 1 compression ratio, 292 cubic inch displacement and 3.75 in. bore by 3.30 in. stroke. And there is a 4-barrel carburetor, dual exhausts plus a special

pressure-type cooling system. Conventional 3-speed transmission is standard. Also available are Overdrive . . . or Fordomatic Drive with its new lightning-fast automatic low gear that means *no waiting* when you want power at the wheels.

HOLDS THE ROAD LIKE A COAT OF PAINT

Ford Engineers designed the Thunderbird's chassis for top strength and minimum weight . . . with an extra-low center of gravity for greater roadability. New Ball-Joint Front Suspension gives the Thunderbird excellent

cornering ability. This advanced type of suspension uses ball joints that have specially shaped seats so that they can't bind or get out of line. They're completely sealed so that water and dirt can't get in.

*For further information about
the **FORD THUNDERBIRD**
see your Ford Dealer*

... CONVERTIBLE TOP CAN BE FOLDED AWAY IN SECONDS!





"HOW I MADE MY HOBBY PAY OFF!"

I've always been interested in cars, then one day I met Joe..."

HI, JOE! SINCE WHEN ARE YOU IN THE AUTO REPAIR BUSINESS?



EVER SINCE I STARTED LEARNING AUTO MECHANICS AT HOME. I EARN WHILE I LEARN, THE NATIONAL SCHOOLS WAY!



SOUNDS GREAT! I HEAR THAT TOP MECHANICS MAKE REAL MONEY THESE DAYS!



YOU SAID IT! I MAY EVEN OPEN MY OWN REPAIR SHOP WHEN I GRADUATE.



NATIONAL SCHOOLS SENT ME THIS SWELL AUTOMOTIVE TOOL KIT—IT'S PART OF MY COURSE!



WHAT A DEAL. I'M FINDING OUT ABOUT THIS AUTO MECHANICS COURSE TODAY!



SHOP-TESTED HOME TRAINING

AUTO MECHANICS & DIESEL NATIONAL SCHOOLS

Technical Trade Training Since 1905
LOS ANGELES 37, CALIFORNIA

In Canada: 811 West Hastings Street, Vancouver, B.C.

APPROVED FOR G.I. TRAINING. Both Home Study and Resident courses offered. Job placement assistance, too! Find out today!



Send for famous illustrated FREE BOOK and FREE LESSON!

MAIL NOW TO OFFICE NEAREST YOU!

(Mail in envelope or paste on postal card)

NATIONAL SCHOOLS, Dept. DB-104

4000 S. FIGUEROA STREET
LOS ANGELES 37, CALIF.

OR 323 WEST POLK STREET
CHICAGO 7, ILL.

Please rush FREE BOOK "Your Future in Auto Mechanics & Diesel." and FREE LESSON. I understand there is no obligation, no salesman will call.

NAME _____ BIRTHDAY _____ 19__

ADDRESS _____

CITY _____ ZONE _____ STATE _____

Check if interested ONLY in Resident Training at Los Angeles.

VETERANS: Give date of discharge _____

in this corner.....

THE EDITORS



"It was certainly one of the most challenging and interesting jobs I ever tackled," says Architect Rudolph A. Matern, designer of "The House You Asked For" featured on the cover and pages 145-150. "When I saw that mountain of questionnaires filled out by *Popular Mechanics* readers on the kind of a house they wanted



I almost got cold feet. I really got a kick out of the big majority that stated their preferences for basements in no uncertain terms because I have been a basement fan for many years. I also enjoyed planning the house in such a way so those with minority preferences would like it, too. That was the hardest part."

Matern, who is nationally famous for his attractive ranch houses, lives and works in Jamaica, Long Island, N. Y.

To the Editor:

I wish to compliment you on your very fine article entitled "Slow Down and Live Longer," as it appeared in the July issue of *Popular Mechanics*. I am glad to see that a magazine of your circulation is taking up the fight against this "highway killer."

I have been interested in photography of all sorts for quite some time, and have followed the results that the Markel Insurance people have had in the use of photography in cutting down the number of accidents for their own company. I am glad to see law enforcement agencies putting

(Continued to page 8)

This **FREE SAMPLE LESSON** will prove you can become an expert **BOOKKEEPER... ACCOUNTANT** OR **C.P.A.**



This well-paid
LaSalle-trained
Accountant's
success could
be yours.

FREE SAMPLE LESSON

We offer you this free sample lesson so that you can prove to yourself that you CAN master Accountancy—quickly, thoroughly—in spare time at home.

You will see exactly how LaSalle's famous "Problem Method" works... how you are led step-by-step through actual accounting work—learning by doing and not by study of theory alone. First you tackle easy problems, then more difficult ones—until soon you master them all. And at every step you have the close personal guidance of LaSalle's large staff of C.P.A. instructors.

HIGHER ACCOUNTANCY

By the LaSalle Problem Method..

• Practical Accounting

Assignment I

THE BALANCE SHEET



QUOTES from the "Journal of Accountancy," the authoritative organ of the professional accountants of the United States:
"The accounting profession is probably the best paid in the world. If there be a profession in which the average compensation is higher, it is not known to us."
"There is need for accountants. There is ample opportunity for advancement. There is no prospect that the society will ever be absorbed within the bosom of any other group of men."

LaSalle Extension University
A Correspondence Institution
CHICAGO

THIS SAME LESSON HAS STARTED HUNDREDS OF THOUSANDS toward well-paid accounting careers—in business, government, and as C.P.A.'s. Even without previous knowledge, progress is rapid—earning power climbs fast. This sample lesson shows why.

If you have been envying the high incomes and good jobs enjoyed by thousands of men and women Accountants today... incomes ranging from \$4,000 to \$10,000 and more per year... why not launch such a career for yourself?

Do you doubt that you can?

Then let us send you—without cost or obligation—the same Lesson Number One with which LaSalle has started several hundred thousand

men and women toward successful accounting careers. We want you to see for yourself how this remarkable method, originated by LaSalle, makes Accountancy simple, interesting, practical, and certain... how it leads you step-by-step to a complete mastery of Accounting—and on up to the coveted degree of Certified Public Accountant if you so aspire.

It doesn't matter whether you've had previous bookkeeping experience, or whether you don't know a debit from a credit. Whether you wish to qualify as an expert bookkeeper, advanced accountant, cost accountant, auditor, government accountant, income tax specialist, or public accountant... you'll find in LaSalle's Problem Method the exact plan to prepare you rapidly and inexpensively—in spare hours at home—without losing a day from your present job.

So right now, today... if you are an adult, employed, and earnestly ambitious for rapid advancement in this highest-paying of all professions... send your name and address on the coupon below. We'll send the free sample lesson—plus our 48-page book outlining today's career opportunities and how you can qualify for them. A coupon like this has started many thousands toward greater success. It can do the same for you. Mail it today!

Clip Coupon... Mail TODAY!

LaSalle Extension University... A Correspondence Institution
Dept. 1064H, 417 S. Dearborn Street, Chicago 5, Illinois

YES, I want to see how LaSalle's "Problem Method" works... how I can qualify for high-pay Accountancy positions. Send Free Sample Lesson—also your 48-page book, "Accountancy, the Profession That Pays" ...all without cost or obligation.

Name..... Age.....
Street Address.....
City, Zone & State.....
Present Position.....



**Nearly 10%
of all C.P.A.'s
in the U.S. have
been trained by the
LaSalle Problem
Method**

GOOD-PAY JOBS IN 5 BIG FIELDS

If you were an expert accountant right now, chances are you would find yourself among the highest-paid of all professional men and women. Surveys show that accountants earn more than those in other major professions.

There are five big fields of opportunity open to Accountancy-trained men and women... opportunities that are wide open and highly inviting, offering maximum income and job security in good times or bad. And under LaSalle's "Problem Method" you can start earning while still learning—either in spare-time or full-time employment... or in business for yourself with no capital required.

Get the latest information by sending for our 48-page book, "Accountancy, the Profession That Pays"... plus free sample lesson. The coupon at right will bring both to you without cost or obligation. LaSalle Extension, 417 S. Dearborn St., Chicago 5, Ill.

WHAT ALL AUTO MECHANICS WANT TO KNOW

1664 PAGES



This Big Practical Book gives full information with working diagrams covering the principles, construction, ignition, service and repair of modern cars, trucks and buses.

Diesel Engines, Hydrumatic & Fluid Drives Fully Explained.

A complete Guide of 1664 pages, with over 1500 illustrations showing inside views of working parts, with instructions for service jobs.

IT PAYS TO KNOW

How to fit pistons—How to locate engine knocks. How to fit connecting rod bearings—How to service main bearings—How to recondition valves—How to time valves—How to adjust fan belts—How to adjust carburetors and chokes. How

to rebuild a clutch—How to service automatic transmissions—How to service brakes—How to adjust steering gear—How to cope with ignition troubles—How to service distributors—How to time ignition—How to "tune up" an engine.



\$4 COMPLETE • PAY \$1 A MO.
TO GET THIS ASSISTANCE FOR YOURSELF SIMPLY FILL IN AND MAIL COUPON TODAY.

Step up your own skill with the facts and figures of your trade. Audels Mechanics Guides contain Practical Inside Trade Information in a Handy Form. Fully illustrated and Easy to Understand, Highly Endorsed. Check the book you want for 7 DAYS FREE EXAMINATION. Send No Money. Nothing to pay postman.

MAIL ORDER



Check NOW!

You Can Look Over Any Guide In Your Own Home — Start the Easy Payments If Satisfied

MAIL THIS TODAY



AUDEL, Publishers, 49 W. 23 St., NEW YORK 10, N. Y.

Please send me postpaid for FREE EXAMINATION books marked (x) below. If I decide to keep them I agree to mail \$1 in 7 Days on each book or set ordered and further mail \$1 monthly on each book or set until I have paid price, otherwise I will return them.

- AUTOMOBILE MECHANICS GUIDE, \$4
- TRUCK & TRACTOR GUIDE, 1299 Pages . . . 4
- DIESEL ENGINE MANUAL, 575 Pages . . . 2
- MACHINISTS HANDY BOOK, 1650 Pages . . . 4
- WELDERS GUIDE, 400 Pages . . . 1
- BLUE PRINT READING, 416 Pages . . . 2
- MATHEMATICS & CALCULATIONS, 700 Pages. 2
- SHEET METAL PATTERN LAYOUTS, 1100 Pages 4
- SHEET METAL WORKERS HANDY BOOK, 388 Pgs. 1
- MECHANICAL DRAWING GUIDE, 160 Pages . 1
- MECHANICAL DRAWING & DESIGN, 480 Pages 2
- AIRCRAFT WORKER, 240 Pages . . . 1
- TELEVISION SERVICE MANUAL, 384 Pages . . 2
- RADIOMANS GUIDE, 914 Pages . . . 4
- ELECTRONIC DEVICES, 216 Pages . . . 2
- ELECTRIC MOTOR GUIDE, 1000 Pages . . . 4
- ELECTRIC WIRING DIAGRAMS, 272 Pages . . 1
- ELECTRICIANS EXAMINATIONS, 250 Pages. . 1
- ELECTRIC POWER CALCULATIONS, 425 Pages. 2
- HANDY BOOK OF ELECTRICITY, 1440 Pages. . 4
- ELECTRIC DICTIONARY, 9000 Terms . . . 2
- ELECTRIC LIBRARY, 7000 Pages (12 Book Set) 18
- MARINE ENGINEERS HANDY BOOK, 1258 Pgs. 4
- SHIPFITTERS HANDY BOOK, 250 Pages . . . 1
- REFRIGERATION & Air Conditioning, 1280 Pgs. 4
- MILLWRIGHTS & MECHANICS GUIDE, 1200 Pgs. 4
- POWER PLANT ENGINEERS GUIDE, 1500 Pages 4
- ENGINEERS & FIREMANS EXAMS, 525 Pages . 1
- PUMPS, Hydraulics & Air Compressors, 1658 Pgs. 4
- ENGINEERS LIBRARY (3 Book Set) . . . 9
- MECHANICAL DICTIONARY, 950 Pages . . . 4
- GARDENERS & GROWERS GUIDES (4 Book Set) 6
- CARPENTERS & BUILDERS GUIDES (4 Book Set) 6
- PLUMBERS & Steamfitters Guides (4 Book Set) 6
- MASONS AND BUILDERS GUIDES (4 Book Set) 6
- PAINTERS & DECORATORS MANUAL, 450 Pgs. 2
- HOUSE HEATING GUIDE, 1000 Pages . . . 4
- OIL BURNER GUIDE, 384 Pages . . . 1

Name _____
Address _____
Occupation _____
Employed by _____

P-10

(Continued from page 6)

this same method into practice and getting equally good results from its use.

I am a clerical worker for the Drivers License Division of the Iowa Highway Safety Patrol and, after spending six days a week on the road for the past three years, I have become very interested in cutting down these "accidents" on our streets and highways. It is very essential that all law enforcement agencies get tough with the people, and use every device available to curb this climbing death rate.

W. R. Baughman,
Oskaloosa, Iowa

To the Editor:

Enclosed please find photographs of my new invention for which a patent has just been issued. I made up this unit by hand and installed it in a home where it has been in use every night for over two years. I am



68 years old and have no money to finance the manufacture other than by hand . . . Maybe I will live long enough to see something come of it. This bed is perfect for apartments, motels, mountain cabins and for private homes where an extra bed is needed and room is scarce.

Victor R. Will,
3108 X St.,
Sacramento 17, Calif.

(Continued to page 12)

ARE YOU TOO OLD TO LEARN?

not at all, scientists say

New tests show that: your ability to think increases with age; your powers of deduction are greater; your judgment is better.

In the I. C. S. files are thousands of cases of men and women of every age. Their successes, their promotions, their raises prove that men and women past school age can learn!

I.C.S. GIVES YOU EXPERT GUIDANCE FREE! Do you have the feeling you're "stuck" in your job? Your trained I.C.S. counselor will appraise your abilities, help you plan for the future.

IT'S NEVER TOO LATE TO GET STARTED! You study with I.C.S. at home, in your spare time. There's no interference with business or social activity. Famous I.C.S. texts make learning easy. Don't delay. Pick your field from the coupon below. And mail it today!



3 FREE BOOKS

36-page, pocket-size guide to advancement, a gold mine of tips on "How to Succeed." Big catalog outlining opportunities in your field of interest. Also free sample I. C. S. lesson.

For Real Job Security—Get an I. C. S. Diploma!

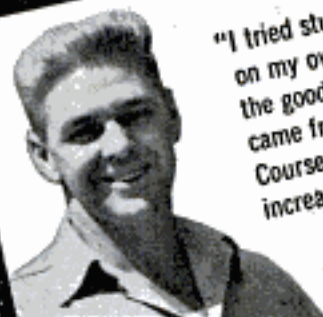

"I tried studying my work on my own, but I never got the good out of it that came from my I. C. S. Course. My salary has been increased 73.3%!"

E.L.B.
Ohio

"I am president of a small corporation. A year ago I enrolled with I. C. S. as the most practical means available to me to learn what I needed."

W.J.A.
Michigan



"It's been so long since I went to school, I've forgotten much. But now that I'm taking an I. C. S. Course, I have confidence in my ability again."

H.A.R.
New Jersey



Actual statements.
Posed by models.

I. C. S., Scranton 9, Penna.

INTERNATIONAL CORRESPONDENCE SCHOOLS

ICS

BOX 5632-L, SCRANTON 9, PENNA.

(Partial list of 277 courses)

Without cost or obligation, send me "HOW TO SUCCEED" and the opportunity booklet about the field BEFORE which I have marked X (plus sample lesson):

ARCHITECTURE and BUILDING CONSTRUCTION

- Air Conditioning—Refrig.
- Architecture
- Building Contractor
- Building Maintenance
- Carpenter and Mill Work
- Estimating
- Heating
- Painting Contractor
- Plumbing
- Reading Arch. Blueprints
- Steamfitting

ART

- Cartooning
- Commercial Art
- Fashion Illustrating
- Magazine Illustrating
- Show Card and Sign Lettering
- Sketching and Painting

AUTOMOTIVE

- Auto Body Rebuilding
- Auto Elec. Technician
- Auto-Engine Tune Up
- Automobile Mechanic

AVIATION

- Aeronautical Engineering Jr.
 - Aircraft & Engine Mechanic
- ### BUSINESS
- Advertising
 - Bookkeeping and Accounting
 - Business Administration
 - Business Correspondence
 - Certified Public Accounting
 - Creative Salesmanship
 - Federal Tax
 - Letter-writing Improvement
 - Managing Small Business
 - Office Management
 - Retail Business Management
 - Sales Management
 - Stenographic-Secretarial
 - Traffic Management

CHEMISTRY

- Analytical Chemistry
- Chemical Engineering
- Chem. Lab. Technician
- General Chemistry
- Natural Gas Prod. & Trans.
- Petroleum Engineering
- Plastics
- Pulp and Paper Making

CIVIL, STRUCTURAL ENGINEERING

- Civil Engineering
- Construction Engineering
- Highway Engineering
- Reading Struct. Blueprints
- Sanitary Engineering
- Structural Engineering
- Surveying and Mapping

DRAFTING

- Aircraft Drafting
- Architectural Drafting
- Electrical Drafting
- Mechanical Drafting
- Mine Surveying and Mapping
- Ship Drafting
- Structural Drafting

ELECTRICAL

- Electrical Engineering
 - Electrical Maintenance
 - Electrician Contracting
 - Linemen
- ### HIGH SCHOOL
- Commercial
 - Good English
 - High School Subjects
 - Mathematics

LEADERSHIP

- Foremanship
- Industrial Supervision
- Leadership and Organization
- Personnel-Labor Relations

MECHANICAL AND SHOP

- Gas—Electric Welding
- Heat Treatment Metallurgy
- Industrial Engineering
- Industrial Instrumentation
- Industrial Supervision
- Machine Design-Drafting
- Machine Shop Inspection
- Machine Shop Practice
- Mechanical Engineering
- Quality Control
- Reading Shop Blueprints
- Refrigeration
- Sheet Metal Worker
- Tool Design Toolmaking

RADIO, TELEVISION

- Electronics
- Practical Radio—TV Eng'ng
- Radio and TV Servicing
- Radio Operating
- Television—Technician

RAILROAD

- Air Brakes Car Inspector
- Diesel Locomotive
- Locomotive Engineer
- Section Foreman

STEAM AND DIESEL POWER

- Combustion Engineering
- Diesel—Elec. Diesel Eng's
- Electric Light and Power
- Stationary Fireman
- Stationary Steam Engineering

TEXTILE

- Carding and Spinning
- Cotton, Rayon, Woolen Mfg.
- Finishing and Dyeing
- Loom Fixing
- Textile Designing
- Textile Eng'g Throwing
- Warping and Weaving

MISCELLANEOUS

- Domestic Refrigeration
- Marine Engineering
- Ocean Navigation
- Shipfitting
- Short Story Writing
- Telephony

Name _____ Age _____ Home Address _____

City _____ Zone _____ State _____ Working Hours _____ A.M. to P.M. _____

Occupation _____

Canadian residents send coupon to International Correspondence Schools, Canadian, Ltd., Montreal, Canada. . . . Special tuition rates to members of the U. S. Armed Forces.

Our 40th Year

NRI training is thorough, practical, up-to-date. When you enroll with NRI you benefit from our 40 years of successful experience training men at home.

J. E. Smith

President
National Radio Institute
Washington, D. C.



I'll Train You RADIO-

You Practice Broadcasting with Parts I Send



As part of my Communications Course I send you parts to build low-power Broadcasting Transmitter at left, and other equipment. Use it to get practical experience. You put this station "on the air," perform procedures demanded of station operators. An FCC Commercial Operator's License can be your ticket to a bright future. My Course trains you to get your license. Mail Coupon now!



Television Is Today's Good Job Maker

Television now reaches from coast-to-coast. More than 25 million Television sets are already in use and require servicing; thousands more sets are being sold every week. About 200 TV stations are now on the air with hundreds more being built. This means new jobs, more jobs, better pay for trained men. The time to act is NOW! Start learning Radio-Television servicing or communications.

You Practice Servicing with Parts I Send

Nothing takes the place of PRACTICAL EXPERIENCE. NRI training is based on LEARNING BY DOING. You use parts I send to build many circuits common to Radio and TV. You build the modern radio at right. Use Multi-tester you build to make money fixing sets. Many students make \$10, \$15 a week extra fixing neighbors' sets in spare time, starting soon after enrolling. All equipment I send is yours to keep.



Make Extra Money in Spare Time While Learning

Keep your job while training. Many NRI students make \$10, \$15 and more a week extra fixing neighbors' Radios in spare time. The day you enroll I start sending you special booklets that show you how to service sets. Multi-tester you build helps discover and correct Radio troubles, gives PRACTICAL EXPERIENCE on circuits common to radio and TV. Mail coupon today.

I Trained these Men at Home



**Laborer
Finds
Success in
Radio-TV**

"I was a laborer with no future. Now I have a position that pays well. My spare time servicing pays good money, too. Thanks to NRI."—Robert Ford, Johnstown, Pa.



**Switched
to TV
Servicing**

"I recently switched from studio work and am now holding a position as TV service technician. Enjoy my work more and more."—Norman Ward, Bridgfield Park, N. J.



**Paid for
Course, Car
in Spare
Time**

"By the time I graduated I had paid for my course, a car and testing equipment. I can handle any job in Radio-TV."—E. J. Streltenberger, New Boston, Ohio.



**\$10 to \$15
Week
Spare Time**

"Four months after enrolling, was able to service Radios . . . averaged \$10 to \$15 a week spare time. Now have full time, business."—W. Weyde, Brooklyn, N. Y.



**Employed as
Transmitter
Operator**

"A former employer recommended NRI training to me. Now employed as transmitter operator in Harrisburg."—Albert Herr, New Cumberland, Penna.

AT HOME for Good Jobs in TELEVISION

There is Success-Good Pay-Security for You in America's Fast Growing Industry



NRI Training Leads to These Jobs in RADIO-TELEVISION

BROADCASTING

Chief Technician
Chief Operator
Power Monitor
Recording Operator

SERVICING

Home and Auto Radios
Television Receivers
P.A. Systems

MANUFACTURING

Design Technician
Service Manager
Tester
Research Assistant

SHIP AND HARBOR RADIO

Chief Operator
Radiotelephone Operator
Assistant Operator

GOVERNMENT RADIO

Operator in Army, Navy, Marine Corps
Airways Operator
Forestry Dispatcher

AVIATION RADIO

Transmitter Technician
Airport Transmitter Operator

TELEVISION

Pick-up Operator
Television Technician
Remote Control Operator

SERVICE AND MAINTENANCE

Technician
POLICE RADIO
Transmitter Operator
Receiver Serviceman

DO YOU want good pay, a job with a bright future, security? Would you like to have a profitable business of your own? If so, find out how you can realize your ambition in the fast-growing RADIO-TELEVISION industry. Even without Television, the industry is bigger than ever before. Just think, over 125 million home and auto Radios, 3000 Radio Broadcasting Stations, plus 25 million Television sets and about 200 Television Broadcasting Stations. Expanding use of Aviation and Police Radio, Micro-wave Relay, Two-way Radio for busses, taxis etc., are making opportunities for Servicing and Communications technicians and FCC Licensed Operators.

My Training Includes Television

You get practical experience by working on circuits common to both Radio and Television. My graduates are filling jobs, making good money in both Radio and Television. Many NRI trained men start their own Radio and Television servicing business with capital earned in spare time. Let me show you how you can be your own boss; earn \$10 to \$15 a week extra even while still learning. Now is the time to get ready for success in Radio-Television. Coupon below brings you Actual Lesson and 64-page book.

Find Out What Radio-Television Offers You

What will YOU be doing one year from today? Decide now that you are going to know more and earn more. ACT NOW. Send the coupon below NOW for my FREE DOUBLE OFFER. You get Actual Servicing Lesson. Also my 64-page Book, "How to Be a Success in Radio-Television." Read what my graduates are doing, earning, see equipment you practice with at home. Mail coupon now. Send in envelope or paste on postal. J. E. SMITH, President, Dept. 4KA, National Radio Institute, Washington 9, D. C. Our 40th Year.

Actual Lesson and 64-page Book

BOTH FREE

The ABC's of SERVICING

MAIL THIS NOW!

MR. J. E. SMITH, President, Dept. 4KA
National Radio Institute, Washington 9, D. C.

Mail me Sample Lesson and 64-page Book FREE. (No salesman will call. Please write plainly.)

Name..... Age.....

Address.....

City..... Zone..... State.....

VETS write in date of discharge.....



Central Operator, Station WEAN

"Received my License and worked on ships. Now with Station WEAN. NRI Course is as complete as any radio course can be."
—Raymond E. Arnold, Rumford, L. I.

Available to **VETERANS** under **G. I. Bills**

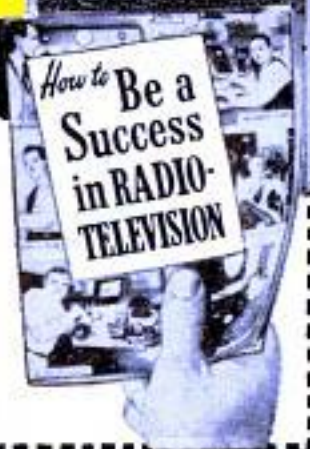

CHANGE for more POWER!

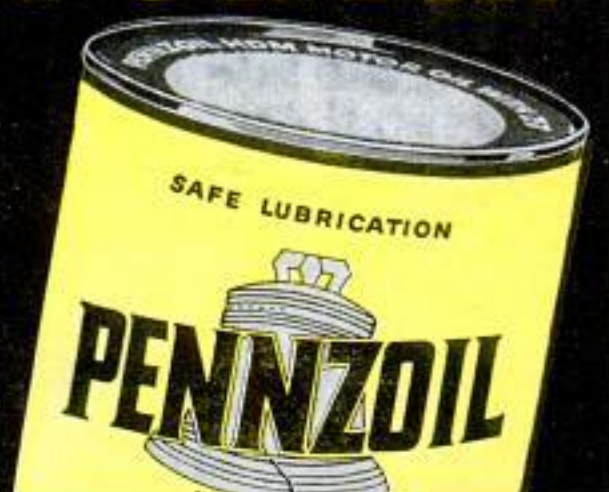

PENNZOIL

THE ONLY
OIL WITH **Z-7**

UNLOCKS HORSEPOWER

- ENDS WINTER SLUDGE PROBLEMS!
- STARTS FAST! PROLONGS BATTERY LIFE!
- STOPS VALVE LIFTER RUSTING!
- ELIMINATES VALVE NOISE!

NO EXTRA COST!

Sound
your

Z



©1954, The Pennzoil Co.,
Member Penn. Grade Crude Oil Assn., Permit No. 2

(Continued from page 8)

To the Editor:

I was somewhat surprised to see the story on Washington State Police in your July issue, which duplicates our endeavors with the traffic camera. I am assured that North Carolina alone is the first and only state using the Markel traffic camera in traffic-enforcement work exclusively.

Bill Crowell,
Director, Public Relations,
Department of Motor Vehicles,
Raleigh, N. C.

Swim While You Ride

Why wait until you reach that vacation spot? You can swim on the train, if the suggestion of an artist for the German

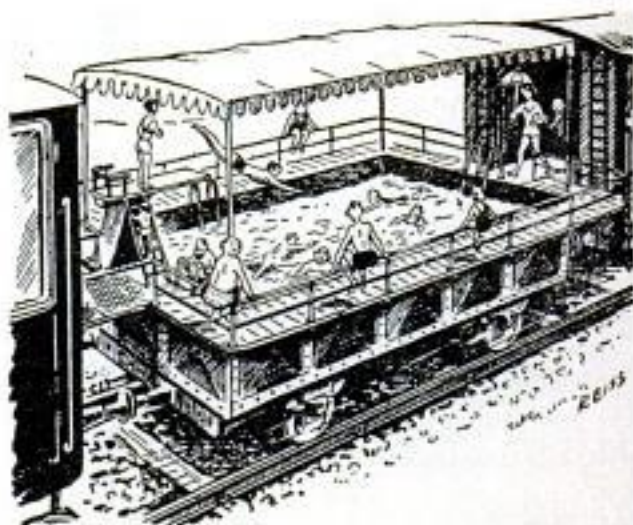

Federal Railway is adopted. He proposes a canopied car with a swimming pool, diving board and all the comforts of a municipal pool. Waves, if any, would be supplied by the motion of the train.

To the Editor:

Your auto edition in February needs special mention. It is the best auto issue produced so far. It covers all the automotive news of the year. I especially appreciate the feature on "What's New in '54." The parade of '54 cars will be better if there is also a parade of all the "dream cars" which are so much in the limelight nowadays. May I suggest that a special edition of all the dream cars be published? The Classic Cars are worth noting.

I must also congratulate you for the excellent article on the University of Mexico in your June issue.

Lee Ah Tong,
Muar, Johore, Malaya

☐ A new electronic "brain" scores students' tests at a rate of 1400 per minute.

INVENTORS

Learn how to protect your invention. The U. S. Patent Laws provide that any new and useful art, machine, article of manufacture, or composition of matter, or any new and useful improvement thereof, may be patented if the act of invention is involved. Therefore, every inventor with a valuable invention should take advantage of the Patent Laws and proceed for patent protection in order to safeguard his rights.

A patent gives the inventor the exclusive right to prevent others from making, using, or selling the invention claimed in the patent for a period of seventeen years.

The Patent Laws were enacted for the benefit of the inventor to give him protection for the features of his invention which are patentable. These features must be properly and concisely set forth and claimed in a formal application for patent, in order to comply with the requirements of the Patent Laws. For that reason, unless the inventor is familiar with patent matters, he should engage a competent registered patent attorney or agent to represent him. We are registered to practice before the U. S. Patent Office and are prepared to serve you in the handling of your patent matters.

A specially prepared booklet entitled "Patent Guide for the Inventor", containing detailed information with respect to patent protection and procedure, together with a "Record of Invention" form will be promptly forwarded to you without obligation upon request.

CLARENCE A. O'BRIEN & HARVEY JACOBSON

Registered Patent Attorneys

41-K DISTRICT NATIONAL BUILDING

WASHINGTON 5, D. C.

FEARLESS FOSDICK by AL CAPP

THAT GIRAFFE STOLE MY DIAMOND NECKLACE!!

THAT'S NO GIRAFFE!!

IT'S ANYFACE-CRIMINAL MASTER OF 1,000 DISGUISES!

SOB!!- MY IDEAL, FOSDICK, HAS GONE BALMY!!

HA!! NO REAL GIRAFFE'D HAVE SUCH DRY, MESSY HAIR!! HE'D USE WILDROOT CREAM-OIL!!

Capr. 1934 by United Feature Syndicate, Inc.

TO KEEP IT NEAT, BUT NOT -UGH!- GREASY!! WHY DON'T YOU GET WILDROOT CREAM-OIL, CHARLIE!!

BUT, THAT'D BE ILLEGAL- MY NAME IS EZIO!!

LOOK YOUR BEST-GET WILDROOT CREAM-OIL. NON-ALCOHOLIC RELIEVES DRYNESS. REMOVES LOOSE DANDRUFF

WILDROOT CREAM-OIL HAIR TONIC

FULLY GUARANTEED TIRES COST LESS!

SPECIAL! REDUCT 10% ON 4 OR MORE TIRES!

Nationally famous FIRESTONE, GOODRICH, U. S. ROYAL, GOODYEAR, and other makes. Every tire selected and inspected for your safety.

FREE TUBE ON REQUEST WITH PASSENGER TIRES WHITE WALL OR SNOW TIRES \$1 EXTRA

HIGH GRADE TIRES GUARANTEED 12 MONTHS

600x16 4.14	700x16 5.14	32x8(8) 8.84	825x20 14.24
650x16 4.54	670x15 4.74	32x6(10) 10.84	900x20 13.34
650x15 4.34	650x20 7.84	750x20(8) 8.54	1000x20 14.14
700x15 4.64	700x20(8) 8.94	750x20(10) 9.94	1100x20 16.14

AAA PREMIUM GRADE GUARANTEED 18 MONTHS

550x15 5.48	700x15 5.98	750x20(10) 14.98
600x16 5.28	700x16 6.78	825x20 18.68
600x16(6) 5.58	700x16(6) 7.98	900x20 18.98
640x15 5.68	750x16(8) 8.98	1000x20 19.98
650x16 5.78	700x20 12.88	1000x22 21.98
650x16(6) 6.08	820x15 7.48	1100x20 20.98
650x15 5.98	710x15 6.08	1100x22 21.98
670x16 6.18	850x20(8) 9.98	1100x24 23.98

MILITARY SPECIAL AA Guaranteed 12 Months—

900x16 10.69	1000x20 19.98
750x20 10.98	1100x20 21.98

NEW TREAD GUAR. 24 MOS.

600x16 8.98
600x16(6) 9.98
700x16(6) 15.98
750x20(8) 24.98

PENNA'S LARGEST STOCK

Largest stock of used tires in the East. Thousands of satisfied customers. Write for Free Catalogue. MONEY ORDER OR CHECK WITH ORDER. NO C.O.D.'s

PYRAMID TIRE CO.
1333-35 North 5th St.
Dept. M., Phila. 22, Pa.

NEW! OIL BURNER

AMAZING HEAT INVENTION

\$14.75 for Stoves
\$29.50 for Furnaces

FITS IN ANY COAL STOVE, RANGE, BOILER OR FURNACE. No more shoveling Coal or Ashes. This Universal Unit makes one of the quickest, hottest, cheapest fires known. Sold on a 60 day Money-Back Guarantee. Send No Money. You will receive Agents Prices and full details by sending your name to

NORTHWEST MFG. CO., 10-M Main, Mitchell, South Dakota

Build your own JET ENGINE!

Order these plans today

1. JET PROPELLED BICYCLE. Assemble your own. Photo and instructions, \$1.00.
2. HOW TO MAKE EXPERIMENTAL JET ENGINES. Seven sheets drawings with information and instructions \$2.95.
3. BOTH OF ABOVE in one order \$3.75. SEND NO MONEY. Order both at once \$3.75 C.O.D. in USA plus c.o.d. postage. Send check or money order and we pay postage. Get other information too. Rush Order.

J. HOUSTON MAUPIN, Dept. 55, Tipp City, Ohio

XMAS MONEY

It's easy with this beautiful all wood 11 in. high SWISS MUNICIPAL CHURCH. Regular Retailer \$7.50. Complete kit \$3.95. Add 50c postage.

PILTZECKER SWISS IMPORTS, Wood-Ridge, N. J.

I'll Send You This Handsome SAMPLE CASE-FREE

and Show You How to Make Up to \$30.00 in a Day

Mail coupon for this Free Tailoring Sample Case packed with 1500 beautiful, big-value suits and overcoat fabrics. Take orders from friends, fellow-workers, others, for fine quality, made-to-measure clothes. Pocket big cash profits in advance. Because wearing our suits and overcoats brings more orders, we make it easy for you to get your own clothes without cost. No experience is needed. SATISFACTION GUARANTEED. SEND NO MONEY. Just fill out and mail coupon - today!

PROGRESS TAILORING CO., 500 S. Throop St. DEPT. 5-216 CHICAGO 7, ILLINOIS

PROGRESS TAILORING CO., Dept. 5-216 500 S. Throop St., Chicago 7, Ill.

Dear Sir: I WANT A MADE-TO-MEASURE SUIT TO WEAR AND SHOW, without paying for it. Rush details and Sample Kit of actual fabrics. ABSOLUTELY FREE.

NAME _____ AGE _____

ADDRESS _____

CITY _____ STATE _____

"Here's your MOST PRACTICAL way to get an education!"

says I.C.S. graduate T. W. PUTNAM
Retail Sales Promotion Mgr.
Fresh Milk & Ice Cream Division
Carnation Company

"From my experience, it appears that the most practical way to get an education is to study with I. C. S.

"First of all, you study alone, with no distraction from others. You lose no time in travel. Your home is your schoolroom.

"Second, you must know your subject—I. C. S. insists on this.

"And third, the lesson you study this evening is put to use the next day, increasing your income, your prestige and your importance to the firm you represent.

"I have recommended I. C. S. to many men. And all those who followed my advice have advanced in position and income."

Will you be next to consider Mr. Putnam's recommendation? Here's the coupon to mark and mail!

I. C. S. is the oldest and largest correspondence school. 277 courses. Business, industrial, engineering, academic, high school. Direct, job related. Bedrock facts and theory plus practical application. Complete lesson and answer service. No skimping. Diploma to graduates.

For Real Job Security—Get an I. C. S. Diploma!



3 FREE BOOKS—

(1) 36-page pocket guide to advancement, a gold mine of information on "How to Succeed." (2) Complete catalog outlining opportunities in your field of interest. (3) Sample lesson demonstrating I. C. S. method. Mail coupon NOW!

I. C. S., Scranton 9, Penna.

INTERNATIONAL CORRESPONDENCE SCHOOLS

ICS

BOX 5633-L, SCRANTON 9, PENNA.

(Partial list of 277 courses)

- Without cost or obligation, send me "HOW TO SUCCEED" and the opportunity booklet about the field BEFORE which I have marked X (plus sample lesson):
- | | | | | |
|--|--|---|---|---|
| <p>ACCOUNTING</p> <p><input type="checkbox"/> Accounting</p> <p><input type="checkbox"/> Accounting System</p> <p><input type="checkbox"/> Installation <input type="checkbox"/> Auditing</p> <p><input type="checkbox"/> Certified Public Accounting</p> <p><input type="checkbox"/> Cost Accounting</p> <p><input type="checkbox"/> Federal Tax</p> <p><input type="checkbox"/> Junior Accounting</p> <p><input type="checkbox"/> Partnership Accounting</p> <p><input type="checkbox"/> Practical Accounting</p> <p>ADVERTISING</p> <p><input type="checkbox"/> Adv. Production</p> <p><input type="checkbox"/> Business Paper Adv.</p> <p><input type="checkbox"/> Department Store Adv.</p> <p><input type="checkbox"/> Direct Mail Adv.</p> <p><input type="checkbox"/> Magazine & Newspaper Adv.</p> <p><input type="checkbox"/> Mail Order Adv.</p> <p><input type="checkbox"/> Psychology of Adv.</p> <p><input type="checkbox"/> Public Relations</p> <p><input type="checkbox"/> Radio and Television</p> <p><input type="checkbox"/> Research and Testing</p> <p><input type="checkbox"/> Retail Adv.</p> <p><input type="checkbox"/> Visualizing the Layout</p> <p><input type="checkbox"/> Window, Interior Display</p> <p>COMMERCIAL ART</p> <p><input type="checkbox"/> Adv. Layout, Illustration</p> <p><input type="checkbox"/> Commercial Cartooning</p> | <p><input type="checkbox"/> Commercial Drawing</p> <p><input type="checkbox"/> Fashion Illustrating</p> <p><input type="checkbox"/> Show-Card Lettering</p> <p><input type="checkbox"/> Sign Lettering</p> <p>ENGINEERING</p> <p><input type="checkbox"/> Aircraft <input type="checkbox"/> Architecture</p> <p><input type="checkbox"/> Chemical <input type="checkbox"/> Civil</p> <p><input type="checkbox"/> Electrical <input type="checkbox"/> Industrial</p> <p><input type="checkbox"/> Mechanical <input type="checkbox"/> Petroleum</p> <p><input type="checkbox"/> Stationary</p> <p>EXECUTIVE MANAGEMENT</p> <p><input type="checkbox"/> Budgetary Accounting</p> <p><input type="checkbox"/> Business Administration</p> <p><input type="checkbox"/> Business Law</p> <p><input type="checkbox"/> Business Management</p> <p><input type="checkbox"/> Business Mathematics</p> <p><input type="checkbox"/> Condensed Business Practice</p> <p><input type="checkbox"/> Credits and Collections</p> <p><input type="checkbox"/> Financing <input type="checkbox"/> Insurance</p> <p><input type="checkbox"/> Interpreting Financial Statements</p> <p><input type="checkbox"/> Letter Writing Improvement</p> <p><input type="checkbox"/> Marketing & Production</p> <p><input type="checkbox"/> Public Relations <input type="checkbox"/> Purchasing</p> <p><input type="checkbox"/> Quality Control</p> <p><input type="checkbox"/> Report Writing</p> | <p><input type="checkbox"/> Retail Business Management</p> <p>INDUSTRIAL</p> <p><input type="checkbox"/> Drafting <input type="checkbox"/> Electronics</p> <p><input type="checkbox"/> Industrial Instrumentation</p> <p><input type="checkbox"/> Quality Control</p> <p><input type="checkbox"/> Reading Blueprints</p> <p><input type="checkbox"/> Shop Practice</p> <p><input type="checkbox"/> Supervision</p> <p>LEADERSHIP</p> <p><input type="checkbox"/> Foremanship</p> <p><input type="checkbox"/> Industrial Supervision</p> <p><input type="checkbox"/> Leadership</p> <p><input type="checkbox"/> Personnel Management</p> <p>OFFICE MANAGEMENT</p> <p><input type="checkbox"/> Indexing and Filing</p> <p><input type="checkbox"/> Office Analysis</p> <p><input type="checkbox"/> Office Communications</p> <p><input type="checkbox"/> Office Forms</p> <p><input type="checkbox"/> Office Management</p> <p><input type="checkbox"/> Office Reproduction</p> <p><input type="checkbox"/> Personnel Management</p> <p><input type="checkbox"/> Supervision</p> <p>PERSONNEL</p> <p><input type="checkbox"/> Collective Bargaining</p> <p><input type="checkbox"/> Employee Relations</p> <p><input type="checkbox"/> Employment Practices</p> | <p><input type="checkbox"/> Incentive Wage Systems</p> <p><input type="checkbox"/> Job Analysis & Evaluation</p> <p><input type="checkbox"/> Labor Relations</p> <p><input type="checkbox"/> Organized Training</p> <p>RETAIL</p> <p><input type="checkbox"/> Advertising</p> <p><input type="checkbox"/> Bookkeeping, Business Forms</p> <p><input type="checkbox"/> Buying, Pricing</p> <p><input type="checkbox"/> Department Store Operations</p> <p><input type="checkbox"/> Retail Merchandising</p> <p><input type="checkbox"/> Retail Salesmanship</p> <p><input type="checkbox"/> Window, Counter Display</p> <p>SALESMANSHIP</p> <p><input type="checkbox"/> Creative Salesmanship</p> <p><input type="checkbox"/> Real Estate Salesmanship</p> <p><input type="checkbox"/> Sales Analysis</p> <p><input type="checkbox"/> Sales Letters</p> <p><input type="checkbox"/> Sales Management</p> <p><input type="checkbox"/> Sales Records and Reports</p> <p><input type="checkbox"/> Selecting Salesmen</p> <p><input type="checkbox"/> Supervising Salesmen</p> <p><input type="checkbox"/> Training Salesmen</p> <p>SECRETARIAL-STENOGRAPHIC</p> <p><input type="checkbox"/> Bookkeeping</p> <p><input type="checkbox"/> Business Correspondence</p> <p><input type="checkbox"/> Business English</p> | <p><input type="checkbox"/> High School Subjects</p> <p><input type="checkbox"/> Secretarial Accounting</p> <p><input type="checkbox"/> Stenography <input type="checkbox"/> Typewriting</p> <p>TRADES AND CRAFTS</p> <p><input type="checkbox"/> Air Conditioning</p> <p><input type="checkbox"/> Apprentice Training</p> <p><input type="checkbox"/> Automotive Repair</p> <p><input type="checkbox"/> Blue Print Reading</p> <p><input type="checkbox"/> Building Trades</p> <p><input type="checkbox"/> Diesel Engines</p> <p><input type="checkbox"/> Domestic Refrigeration</p> <p><input type="checkbox"/> Internal Combustion Engines</p> <p><input type="checkbox"/> Plumbing & Heating</p> <p><input type="checkbox"/> Radio Servicing</p> <p><input type="checkbox"/> Railroad <input type="checkbox"/> Sheet Metal</p> <p><input type="checkbox"/> Television Servicing <input type="checkbox"/> Textiles</p> <p>TRAFFIC MANAGEMENT</p> <p><input type="checkbox"/> Air Services</p> <p><input type="checkbox"/> Freight Class. Rules</p> <p><input type="checkbox"/> Freight Services, Facilities</p> <p><input type="checkbox"/> Motor Traffic Management</p> <p><input type="checkbox"/> Regulation of Carriers</p> <p><input type="checkbox"/> Shipping Documents</p> <p><input type="checkbox"/> Tracing, Expediting, Claims</p> <p><input type="checkbox"/> Traffic Control, Management</p> |
|--|--|---|---|---|

Name _____ Age _____ Home Address _____

City _____ Zone _____ State _____ Working Hours _____ A.M. to P.M. _____

Occupation _____

Canadian residents send coupon to International Correspondence Schools, Canadian, Ltd., Montreal, Canada. . . . Special tuition rates to members of the U. S. Armed Forces.

WHAT SECRET POWER DID THIS MAN POSSESS?



BENJAMIN FRANKLIN
(A Rosicrucian)

WHY was this man great? How does anyone—man or woman—achieve greatness? Is it not by mastery of the powers within ourselves? Know the mysterious world within you! Attune yourself to the wisdom of the ages! Grasp the inner power of your mind! Learn the secrets of a full and peaceful life!

Benjamin Franklin—like many other learned and great men and women—was a Rosicrucian. The Rosicrucians (NOT a religious organization) first came to America in 1694. Today, headquarters of the Rosicrucians send over seven million pieces of mail annually to all parts of the world. Write for YOUR FREE COPY of "The Mastery of Life"—TODAY. No obligation. No salesmen. A non-profit organization. Address: Scribe I.D.W.

THIS BOOK FREE!



The ROSICRUCIANS

SAN JOSE • (AMORC) • CALIFORNIA

—SEND THIS COUPON—

Scribe I.D.W.
The ROSICRUCIANS (AMORC)
San Jose, California
Please send me the free book, *The Mastery of Life*, which explains how I may learn to use my faculties and powers of mind.

Name _____

Address _____

City _____

INVISIBLE REWEAVING

Make Big Money at Home!

BEFORE



AFTER



WOMEN (AND MEN, TOO) FIND FINANCIAL SECURITY—AT HOME!

The demand is endless. Laundries, cleaners, tailors, department stores, homes—everybody needs professional reweaving service sooner or later. And skilled craftsmen are scarce! Learn to make cuts, moth holes, burns, tears DISAPPEAR from coats, suits, dresses, all fabrics almost like magic! AND EARN UP TO \$10 IN AN HOUR AT HOME!

The ORIGINAL, Complete Professional Course . . .

You need no special education, experience or ability. Age doesn't matter. Learn all the secrets of this fascinating profession in a few short weeks—start earning at once!

FREE GET THRILLING DETAILS NOW! Make no mistake! This is a complete, professional course . . . with professional equipment, written by experts. Not a gadget. Not a condensed, unsatisfactory short-cut. FABRICON offers the ORIGINAL home-study course . . . first, best, most-complete in the field. It prepares you for professional work, and for professional earnings. Write TODAY for complete details FREE. FABRICON CO., Dept. 3218, 8342 S. Prairie Ave., Chicago 18, Ill.

MEN! Invisible Reweaving offers as much promise for profit to men . . . as it does to women. A great number of our successful students are men. Men can learn to do the work as well and as quickly as women. Actually, Invisible Reweaving is the perfect "team" business—for man and wife . . . or even the entire family! Write!

TASOPE PHOTO-ENGRAVING PLANTS



Material Cost of This Cut 34¢
Selling Price \$1.00 And Up

Establish your own profitable PHOTO-ENGRAVING business. Make cuts for newspapers, printers, and advertisers. Make etched name plates, plaques etc. Instructions furnished, no experience necessary. Sold direct from factory since 1931. First five hundred cuts sold locally or by mail will pay for plant and pay you well for your time. Write for FREE catalog.

TASOPE, DEPT. PM-10, AURORA, MO.



MECHANICAL DENTISTRY

To make Crowns, Plates, Bridgework, etc., for Dentists. Easy practical way to learn mechanical dentistry at home in spare time. FULL EQUIPMENT OF TOOLS AND MATERIALS INCLUDED WITH COURSE. Low tuition. Easy terms. Write for FREE BOOK about this money making profession that is not affected by machine age.

McCARRIE SCHOOL OF MECHANICAL DENTISTRY
207 N. Broad St., Dept. 34, Philadelphia 7, Pa.

RAISE GIANT FROGS

BIG DEMAND



Nuford Giants

MILLIONS USED YEARLY! Good prices year round! Breeder lays up to 20,000 eggs yearly. Nation-wide markets waiting for all you can ship. Get ready now for next spawn. New book tells how! Small pond starts you. Men and Women send for my illustrated FREE folder today. Do it now!

ALBERT BROEL-7
P.O. Box 506. New Orleans 3, La.

WOODWORKING

Low Cost Home Craft Courses Now Available

Make money. Become a skilled woodworker. Interstate's new woodworking course tells and shows how to turn out hundreds of professionally constructed and finished wood projects with hand and power tools. Twenty-two profusely illustrated manuals. Over 1,000 pages. Over 75 projects. Written by expert instructors. The only complete course available today! Get full information without obligation . . . today.



Write for FREE Booklet

INTERSTATE TRAINING SERVICE

SCHOOL OF WOODWORKING
DEPT. F-3-K, PORTLAND 13, OREGON

INVENTORS

If you believe that you have an invention, you should find out how to protect it. The first step is to have a search made of the prior pertinent U. S. patents. If a report on this search indicates that the invention appears patentable you can apply for a patent, and the specifications and claims should be prepared.

The firm of McMorrow, Berman & Davidson, with offices in Washington, D. C., is qualified to take the necessary steps for you. We can make a preliminary search on your invention, advise you whether we think it can be patented, and prepare your application for patent.

Unless you are fully familiar with the U. S. Patent Laws, we recommend that you engage the services of a Registered Patent Attorney to protect your interests. The patent laws are *your* laws. A patent gives you the right to prevent others from making, using or selling the invention claimed in your patent for a period of 17 years.

Use these patent laws for your protection. Investigate whether your invention can be patented. If you have what you believe to be an invention, we suggest that you have this firm make a search for you:

Send for a copy of our Patent Booklet entitled "How To Protect Your Invention," containing information about patent protection and patent procedure. Along with this we will also send you an "Invention Record" form, for your use in writing down and sketching details of your invention. We will mail them promptly. No obligation. They are yours for the asking.

McMORROW, BERMAN & DAVIDSON

Registered Patent Attorneys

PATENTS • COPYRIGHTS • PATENTS

1357 VICTOR BUILDING, WASHINGTON 1, D. C.

WHERE-TO-BUY-IT INDEX

Source of supply appears after items commercially available

AUTOMOTIVE

Nonfade car radio (Motorola, Inc., 4545 W. Augusta Blvd., Chicago 51).....	102
Flats changed on the fly.....	128
Miniature V8 motor.....	129
Headrest for mechanic's creeper (Smash-Proof Co., Ashtabula, Ohio).....	129
Ambulance radio transmitter turns traffic lights to red (North American Aviation, Inglewood, Calif.).....	141

AVIATION

Movie film operates automatic riveter in aircraft plant (Convair, San Diego, Calif.).....	103
Portable radar unit designed especially for small airports (Laboratory for Electronics, Inc., 75 Pitta St., Boston 14, Mass.).....	105

FARM AND GARDEN

Crane made from scrap lifts farm machinery.....	113
Leaf-raking machine built from scrap parts.....	124
Power cart rolls to job (Master Mechanics Mfg. Co., Burlington, Wis.).....	125
Pulverizer for rotary mower ends need for raking leaves (Bolens Products Div., Food Machinery and Chemical Corp., 343 S. Park St., Port Washington, Wis.).....	141

HOUSE AND HOME

What's New for Your Home—	
Faucet unit rebuilds old faucets (Acme Brass Mfg. Co., Los Angeles, Calif.).....	126
Coffee table converts to a writing desk (Brown-Saltman, Chicago).....	126

Hone sharpens scissors of any type (F & B Products Co., 2668 Edgemoor Road, Cleveland, Ohio).....	126
Phone seat folds into wall when not in use (Claude Siedd Lumber, 435 N. 3rd, Muskogee, Okla.).....	126
Timers for gas ranges (Robertshaw-Fulton Controls Co., Greensburg, Pa.).....	127
Moisture conditioner (Admiral Conditioner, 3800 Cortland St., Chicago 47, Ill.).....	127
Gas furnace dries clothes in addition to heating (Herbster Products Co., 877 Addison Road, Cleveland 3, Ohio).....	127
Disappearing shelf (Kitchen Maid Corp., Andrews, Ind.).....	127
Moving surface for ironing board.....	129
Flagstone-shaped asphalt tiles fit between "mortar" pattern (Armstrong Cork Co., Lancaster, Pa.).....	135

MISCELLANEOUS

Amphibious craft combines boat, automobile and airplane.....	102
Hydraulic wedge topples trees (Hufford Machine Works, Inc., 1700 E. Grand Ave., El Segundo, Calif.).....	102
Artificial stream carries sugar cane across Hawaiian jungle.....	103
Torpedo tries again if first pass misses.....	113
Venezuelan home anchored to hillside seems to float on air.....	113
Landing net with scale built into handle weighs large or small fish (National Sideline, Argenta, Ill.).....	124
Scroll books turn "pages" for handicapped persons.....	129
Display "biggest photo in Turkey".....	134
Small meter prints postage and moistens envelopes (Pitney-Bowes, Inc., Stamford, Conn.).....	141
Driving range for beginners.....	142

SCIENCE

Find new way to make ice.....	124
Coconut water introduced into bloodstream replaces body fluids.....	134
Electron shooters in "junior" sizes.....	135

Radio-Television, Electronics

Color TV receiver (Motorola, Inc., 4545 W. Augusta Blvd., Chicago 51).....	245
--	-----

(Continued to page 24)

Inventors

The following are the usual preliminary steps to take toward patent protection.

You are advised first, to make a disclosure of your invention. Date, sign and have this document witnessed by two or more persons who are capable of understanding your invention. The "Evidence of Invention" form mentioned below, we offer as a convenience in making your disclosure and in starting action leading toward patent protection.

Mail your disclosure to the registered patent attorney or agent whom you select to assist you, together with a letter authorizing him to conduct a

preliminary search among previously granted U. S. patents for similar types of invention. He then prepares for you a report on the probable patentability of your invention and, if the report is favorable, recommends the further course you should take.

This firm is registered to practice before the U. S. Patent Office and is available to assist you in the preparation and prosecution of patent applications. We shall be glad to send you without obligation, the "Evidence of Invention" disclosure form mentioned above and our instructive booklet, "Patent Protection for Inventors".

VICTOR J.
EVANS & Co. *Merlin M. Evans*
REGISTERED PATENT ATTORNEY
930-L MERLIN BUILDING, WASHINGTON 6, D. C.

THESE MEN ARE GETTING PRACTICAL TRAINING IN **ELECTRICITY**

—**ELECTRONICS**

On Real:



**A.C. and D.C. MOTORS
GENERATORS
SWITCHBOARDS
CONTROLLERS
WIRING JOBS
APPLIANCES
ELECTRONIC UNITS**

(Shown at left—Instructor explaining operation and testing of a large Motor Generator in our A.C. Department.)

AND **TELEVISION-RADIO**

On Real:

**TELEVISION SETS
RADIO RECEIVERS
F.M.
(Frequency Modulation)
ELECTRONICS
RECORD CHANGERS
AUTO RADIOS
PUBLIC ADDRESS Systems**

(Right—Instructor helping students check the wiring and trace circuits of television receivers.)



Train in the great **SHOPS** of **COYNE**

Largest, Oldest, Best Equipped School Of Its Kind In The U. S.

Whether 17 or up to 45 years of age, prepare for your future now. Don't be satisfied with a "No Future" job. Train the Coyne way for a better job in a field that offers a world of opportunities in the years ahead.

FINANCE PLAN Enroll now, pay most of tuition later. Part-time employment service while training, if needed.

WE TRAIN YOU IN CHICAGO. At Coyne you learn on real, full-size equipment. Trained instructors show you how, then you do practical jobs yourself. No previous experience or advanced education needed.

CLIP COUPON NOW for big new illustrated Coyne book "Guide to Careers in **ELECTRICITY** and **TELEVISION-RADIO**". No obligation; no salesman will call. Get vital facts now!



*Mail Coupon for
Big Free Book*

**APPROVED
FOR
VETERANS**

**B. W. COOKE, President
COYNE ELECTRICAL SCHOOL
500 S. Paulina St., Chicago 12, Ill. Dept. 74-72H**

Send **BIG FREE** book and details of your training offer. This does not obligate me and no salesman will call. I am interested in:

ELECTRICITY **TELEVISION-RADIO**

NAME

ADDRESS.....

CITY.....STATE.....

B. W. COOKE, Pres. **COYNE** FOUNDED 1895
ELECTRICAL SCHOOL

**A TECHNICAL TRADE INSTITUTE CHARTERED NOT FOR PROFIT
500 S. PAULINA ST., CHICAGO, Dept. 74-72H
ELECTRICITY ★ RADIO ★ TELEVISION ★ REFRIGERATION ★ ELECTRONICS**

5 YEARS' RESEARCH PAYS OFF! 17 PT. SELF CLEANING PLUG FIRES HOT, STEADY AT 50,000 MI. CHECK!

PERMANENT GAP: After months of use **LIFE-TIME** Spark Plugs mike at exact factory pre-gap. Now—order registered set at popular price!

Most spectacular spark plug research breakthrough in 50 years allows us to make this unique and unprecedented statement—**WE GUARANTEE MORE GAS MILEAGE—GREATER ACCELERATION—A MAJOR POWER INCREASE—OR YOUR MONEY BACK.**

TO MATCH LIFE-TIME'S radically advanced electrode design... superior construction throughout.

- 1. SPECIAL SINTERED CORUNDUM INSULATOR** to withstand the increased requirements of high-compression engines. Special insulator is designed to actually vaporize and exhaust wet carbon and oil. Better combustion eliminates cleaning.
- 2. PLATINUM-NICKEL ALLOY ELECTRODES.** Metallurgists' first major step beyond platinum aircraft plug electrodes. Electrodes made of this alloy have continued to function after 120,000 miles and are still going strong! This is 12 times the life expectancy of other plugs.
- 3. WIDER GAP ALLOWED.** New design improves slow speed, idling performance.
- 4. 100% INSPECTED TESTED.** Every LIFE-TIME Spark Plug must pass individual inspection and testing.



SELF CLEANING FOR LIFE
Confined gases exploding in chamber formed by multiple electrodes re-clean with each piston stroke.

For the first time you can now get a spark plug in your car, truck, boat or industrial engine, which was designed from the start to use fully and economically the modern high-octane leaded fuel you are now using.

WASTING ONE GALLON IN TEN?

Regardless of how well your car is tuned, you may be wasting one gallon in every ten you pay for—due to faulty spark plugs. Rapid deterioration is the key to this big yearly waste of your dollars.

"CREEPING PARALYSIS"

You can always feel a complete plug failure. But,

you may not notice the "creeping paralysis" of gradually disintegrating plug electrodes, carbon build-up, gradually widening gap, all of which throw off timing, drastically reduce power, cause idling, slow and uneven acceleration.

FIRST 17 PT. ROTATING SPARK

For years automotive engineers have been acutely aware of the crying need for a vast stride forward in the design of the spark plug—UP UNTIL NOW THE MOST OFTEN REPLACED PART OF YOUR ENTIRE AUTOMOBILE! The 17 PT. LIFE-TIME SPARK PLUG is our guaranteed answer to this need. The LIFE-TIME Spark Plug is the final result

of world-wide research and development which has gone from the original 2-electrode plug through a wide variety of double and triple electrode systems until the practical application of the full 360 degree rotating spark perfected in the LIFE-TIME plug. The new principle of full rotating spark gives more complete firing, is vastly superior to expensive platinum points once used in aircraft.

ONCE COST \$17 EACH!

The LIFE-TIME Spark Plug has been brought down from \$17 each to a cost of just 99¢ apiece—an amazing example of U.S. production methods and know-how!



YOU RECEIVE BY MAIL THIS MATCHED, REGISTERED SET You receive your matched, registered set of LIFE-TIME Spark Plugs of proper series (heat range and gap) for the car you indicate in coupon below.

GUARANTEE Your registered set also bears a warranty guaranteeing greater gas mileage, more power, greater top speed, greater acceleration and less oil dilution than with any spark plug you have ever used, or full refund to you of the purchase price. Performance must even exceed more expensive European imports!

DEAR CAR OWNER: The 17 PT. LIFE-TIME Spark Plug has been my baby now for five years. During this time the big problem has been, "How can we take this remarkable plug out of the special race, test and economy-run class and put it in your car at your price?" Time and ingenuity have licked this problem. I hope you will write me about your personal experience with it, and I will greatly enjoy hearing from you. Many thanks!



Frank Williams
FRANK E. WILLIAMS, M.E.
Inventor of Life-Time Spark Plug

WHAT DOES 17 PT. FIRING MEAN? Note construction closely. A completely circular firing area consisting of four concave segments (electrodes). Distance to the center electrode being equal at all points, electricity has the property of arcing from the coldest point. Electricity also arcs more readily from the apex of two planes than from the face of a flat metallic surface.



See above that there are 16 apex (places where two planes meet) on the outer circular electrode of the LIFE-TIME Spark Plug all exactly the same distance from the center electrode!

17 ARC POINTS—360 DEGREES Normal heat and spark erosion are spread around the entire 360 degrees of the circular electrodes and around the entire circumference of the center electrode! Firing simultaneously from 2 or more of the 16 outer points, LIFE-TIME plugs give a larger spark for more complete combustion.

FULL ROTATING SPARK ALLOWS OVERALL COOLER ELECTRODE TEMPERATURE FOR GREATLY INCREASED LIFE. This allows the use of a hotter spark to avoid fouling, yet the cooling effect of the multiple electrode system (plus superior heat conductivity) minimizes the common faults of burning, erosion, blistering and insulator failure.

A larger, more powerful spark every time gets more miles from every gas dollar you spend. Giving better gas economy, increased power, acceleration and top speed. Compare this principle with the conventional 2-point spark plug design.



1. MAKE THIS TEST WITH YOUR OWN CAR! Time your acceleration from 0 to 60 mph with any other spark plug. Then time 0 to 60 mph with LIFE-TIME Spark Plugs in your car. This test performed in a hopped-up 1952 Merc cut 2 full seconds of the time when LIFE-TIME plugs were installed!

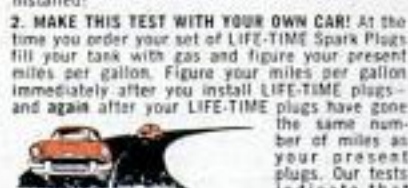

2. MAKE THIS TEST WITH YOUR OWN CAR! At the time you order your set of LIFE-TIME Spark Plugs fill your tank with gas and figure your present miles per gallon. Figure your miles per gallon immediately after you install LIFE-TIME plugs—and again after your LIFE-TIME plugs have gone the same number of miles as your present plugs. Our tests indicate that both tests with LIFE-TIME Spark Plugs will show from 4% to 13.5% greater gas mileage than with any conventional spark plug.

DEALERS AND DISTRIBUTORS Write us today for sales details on the revolutionary new LIFE-TIME Spark Plug.

Life-Time Spark Plug Division—CONTINENTAL MANUFACTURING CORP.
Department PM-10, 10411 W. Washington Blvd., Culver City, Calif.
Gentlemen: Please mail postpaid _____ set(s) (matched, registered) of LIFE-TIME Spark Plugs at 99¢ per plug. (Set of six...\$5.88) (Set of eight...\$7.84)
OR \$1.00 Deposit, Balance C.O.D.
Make of my car is _____, Year _____, Model _____, No. Cyl. _____
Name _____
Address _____
City _____ Zone _____ State _____

All Electronic Parts
YOURS TO KEEP!

Now!
Work over
300
practical projects
WITH THESE
PARTS!!!



MULTIMETER

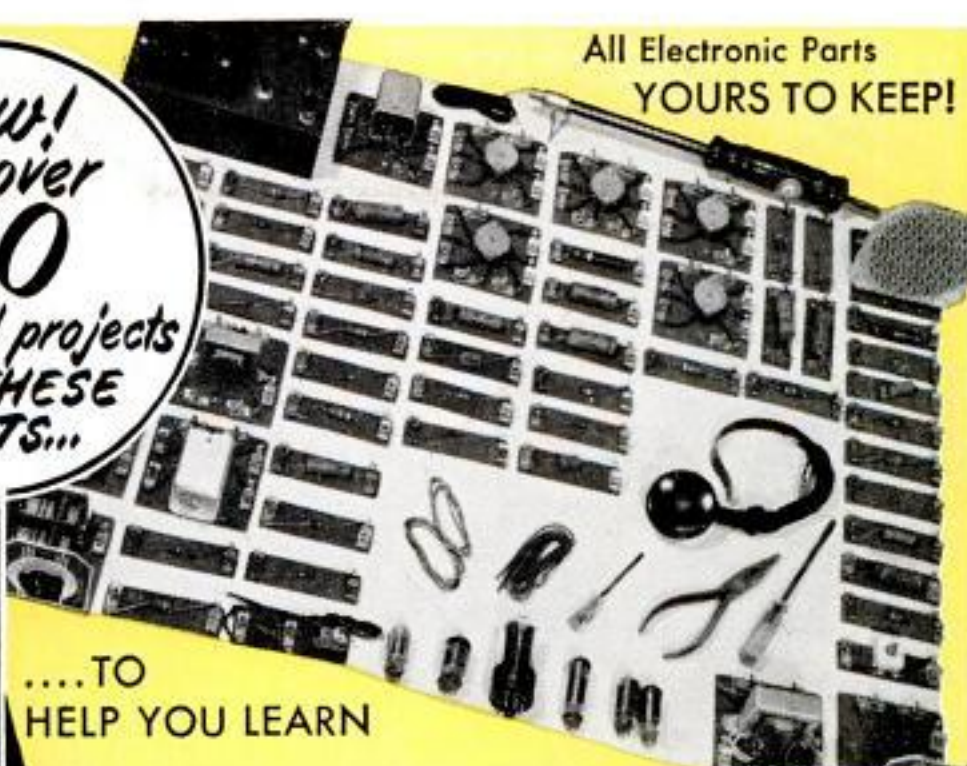

.... TO
HELP YOU LEARN

TELEVISION

RADIO-ELECTRONICS Now... at home in spare time you can get BOTH the very training and subsequent Employment Service you need to help you start earning real money in America's thrilling, multi-billion dollar opportunity field of Television-Radio-Electronics. Now that Television is coming to almost every community, here is a chance of a lifetime to prepare to cash in on one of Television's great expansions.

D.T.I.'s amazingly practical home method enables you to set up your own HOME LABORATORY. You get many Electronic parts which you mount on individual bases with spring clip connectors. Taps for experimenting! Add or remove parts in a jiffy. No wasted hours of soldering and unsoldering for each project. You spend minimum time to get maximum knowledge of important circuits that really work. In fact, you get exactly the same type of basic training equipment used in our Chicago training laboratory—one of the nation's finest.

Build and KEEP This VALUABLE TEST EQUIPMENT

Your home laboratory projects also include building and keeping a versatile 5 inch Oscilloscope and precision Jewel Bearing Multi-Meter. These quality commercial test instruments help you EARN WHILE YOU LEARN and will prove mighty valuable, should you later decide to start your own full time TV-Radio service business. You also build and keep a quality 21 inch TV SET.

D.T.I. Provides EVERYTHING YOU NEED to master TELEVISION

In addition to your home laboratory and easy-to-read lessons, you even use HOME MOVIES—a wonderfully effective and exclusive D.T.I. training advantage. You watch hidden actions... see electrons on the march. Important fundamentals... become "movie clear," helping you learn faster... easier... better.

Full time Residential training in D.T.I.'s great Chicago laboratories also available. MAIL COUPON TODAY for all facts. (If subject to Military Service, you'll especially welcome the information we have for you.)

D.T.I.'s Training
is available in Canada



**89 WAYS
TO
EARN
MONEY**

MAIL COUPON TODAY!

DEVRY TECHNICAL INSTITUTE

Dept. PM-10-K

4141 BELMONT AVE., CHICAGO 41, ILL.

I would like your valuable information-packed publication showing how I can get started toward a good job or my own business in Television-Radio-Electronics.

Name _____ Age _____

Street _____ Apt. _____

City _____ Zone _____ State _____

Build and keep this BIG DTI
Engineered TV set—easily
converted to U.H.F. (DTI offers
another home training, but
without the TV set.)



"ONE OF AMERICA'S FOREMOST
TELEVISION TRAINING CENTERS"

DEVRY TECHNICAL INSTITUTE

AFFILIATED WITH

DEFOREST'S TRAINING, INC.

CHICAGO 41, ILLINOIS

NOW

SAVE! BUY DIRECT FROM THE IMPORTER!



FREE!

Yours **FREE** of extra cost—with any article ordered from this ad—a sparkling new pair of **SPECTO-SCOPES**—the binoculars you wear like eyeglasses! They give you close-up viewing all day—without fatigue! More thrills from T-V, sports, movies.

theatre are yours with **SPECTO-SCOPES**. Nationally advertised at 1.98. Order with confidence! Every item guaranteed! Money back if not delighted within 5 day trial! **RUSH!** Offer limited!

7 X, 35 LIGHT WEIGHT

Ultra-powerful, yet compact—only 5 inches high and **SO** light! Genuine **Klaroptar** coated lenses. **\$34.95** (FT)

Synchronized center focusing. Weighs only 1/2 of regular 7 X binoculars. Prismatic lens system gives needle-sharp definition. Slips easily into coat pocket. We've sold hundreds at much higher prices. Order by No. 170. Special to readers of this magazine, including tax and pigskin case, only.....\$34.95

7 X, 50 mm \$29.50 TAX PAID

Same high quality as our 7 x 35's. Has all above features, including **CENTER** focusing. Handsome pigskin case, Needle-sharp viewing even at night. Our very **BEST** value. No. 147, tax paid.....\$29.50



FAMOUS KORUIM STEEL "BLACK FOREST" HUNTING KNIFE

Famed **BLACK FOREST** Hunting Knife made in Solingen, Germany. Super-fine **KORUIM** Steel. Rugged beauty of this knife has already won recognition for design in Europe. Its utility as a hunting and fishing aid has made it a prime favorite with sportsmen on both continents. Blade is actually sharp enough to shave with! Will stand up under most rugged treatment. Genuine leather scabbard is handsomely metal-tipped. Length: 10 inches. Tough, sturdy **KORUIM SOLINGEN** steel assures you years of dependable service! The sleek, graceful lines of this German import also provide an ideal gift for men! Order by No. 80. **Special Value**\$3.95



OUTSTANDING VALUE!

17 JEWEL SWISS \$19.95 AUTOMATIC

Super Deluxe Model—**FULL SWING 17-JEWEL SELF-WINDING AUTOMATIC MEN'S WATCH**. Just set it... then forget it! It winds itself as you wear it. Patented **INCA-BLOC 17-Jewel** Swiss movement of superb accuracy. Water and shock resistant—you can **DROP** it... **BANG** it... even **SWIM** with it! 100% **Stainless Steel** screw back. Gilt hands & numerals with **LUMINOUS** markings. Unbreakable **Kleersite** crystal. Hairline Sweep Second hand. Split-second calibrations for precision timing. Metal-Flex expansion band. Handsome thin-styled case. Caution: do **NOT** confuse with inferior 180 degree **Half-SWING** automatics. This superb watch is 360 **FULL SWING**. Formerly sold for much, **MUCH** more—**NOW 19.95** tax incl. Order **TODAY!** Send coupon with payment and receive also **FREE Specto-Scopes**. Order by No. 238.



18 KARAT ROLLED GOLD PLATE \$19.95

17 Jewel CHRONOGRAPH
Our **BEST** value! Deluxe **18 KARAT** Rolled Gold Plate model with stainless steel back—yours **BELOW WHOLE-SALE PRICE!** It's the **ONE** and **ONLY** genuine Recipro-Register Chronograph. Computes speeds and distances down to 1/5th of a second! Genuine **Incabloc 17 Jewel** movement resists shocks of work and play. Remembers for you while movement continues to keep time! **TIMES:** Races, Planes, Sports, Photos, Shop Work, Lab Experiments, Lightning, etc.—**AUTOMATICALLY**. Extra features: Multi-Function synchro dials; Contact clutch starts computation, Brake clutch **FREEZES** result. Also **ERASES** back to zero. Radium dial, Hair Line Sweepsecond. Instructions, gift case and leather band included. Order by No. 233-GP. Rock-bottom price direct to you, tax paid.....\$19.95



SAVE MONEY WITH THIS COUPON!

THORESEN'S, Dept. 6-L
352 Fourth Avenue, New York 10, N. Y.

RUSH! the items checked on 5-Day Free Trial... Money Back Guarantee. Include with each item ordered one pair of Specto-Scopes at no extra cost—mine to keep in any case.

- Payment enclosed. Send tax & postpaid.
- Send COD plus postal charges.

CANADIANS: Save Tariff! Send orders direct to: THORESEN CO., Dept. 6-L, 45 St. James St. West, Montreal 1, P.Q

- No. 170—7X, 35 BINOCULARS...\$34.95
- No. 80—Black Forest Knife & Scabbard \$3.95
- No. 147—7X, 50 BINOCULARS...\$29.50
- No. 238—17 Jewel Automatic Self-Winding Watch.....\$19.95
- No. 233-GP.—18 K. Gold Plate 17 Jewel Watch.....\$19.95

NAME _____
ADDRESS _____
CITY _____ ZONE STATE _____

GET
INTO

RADIO-TELEVISION

ELECTRONICS by Shop-Method Home Training

GOOD JOBS AWAIT THE TRAINED RADIO-TV TECHNICIAN

There is a place for you in the great Radio-Television-Electronics industry when you are trained as National Schools will train you at home!

Trained technicians are in growing demand at good pay—in manufacturing, broadcasting, television, communications, radar, research laboratories, home Radio-TV service, and other branches of the field. National Schools Master Shop-Method Home Training, with newly added lessons and equipment, trains you in your spare time, right in your own home, for these fascinating opportunities. OUR METHOD IS PROVED BY THE SUCCESS OF NATIONAL SCHOOLS TRAINED MEN, ALL OVER THE WORLD, SINCE 1905.

EARN WHILE YOU LEARN

Many National students pay for all or part of their training with spare time earnings. We'll show you how you can do the same! Early in your training, you receive "Spare-time Work" Lessons which will enable you to earn extra money servicing neighbors' and friends' Radio and Television receivers, appliances, etc.



Signal Generator

Audio Oscillator

T. R. F. Receiver

National Schools Training is All-Embracing

National Schools prepares you for your choice of many job opportunities. Thousands of home, portable, and auto radios are being sold daily—more than ever before. Television is sweeping the country, too. Co-axial cables are now bringing Television to more cities, towns, and farms every day! National Schools' complete training program qualifies you in all fields. Read this partial list of opportunities for trained technicians:

- Business of Your Own • Broadcasting
 - Radio Manufacturing, Sales, Service • Telecasting
 - Television Manufacturing, Sales, Service
 - Laboratories: Installation, Maintenance of Electronic Equipment
 - Electrolysis, Call Systems
 - Garages: Auto Radio Sales, Service
 - Sound Systems and Telephone Companies, Engineering Firms
 - Theatre Sound Systems, Police Radio
- And scores of other good jobs in many related fields.

TELEVISION TRAINING

You get a complete series of up-to-the-minute lessons covering all phases of repairing, servicing and construction. The same lesson texts used by resident students in our modern and complete Television broadcast studios, laboratories and classrooms!



MASTER ALL PHASES!

Get Master Shop-Method Home Training from an Established Practical Resident School with its own Training with almost 50 Years of Successful Experience in Training Ambitious Men.



Shops, Laboratories, Studios — almost 50 Years of Successful Experience in Training Ambitious Men.

We Bring National Schools To You!



You also receive this Multimeter

Superheterodyne Receiver

LEARN BY DOING

You receive and keep all the modern equipment shown above, including tubes and valuable, professional quality Multimeter. No extra charges.

FREE! RADIO-TV BOOK AND SAMPLE LESSON!

Send today for National Schools' new, illustrated Book of Opportunity in Radio-Television-Electronics, and an actual Sample Lesson. No cost—no obligation. Use the coupon now—we'll answer by return airmail.

APPROVED FOR
VETERANS
AND
NON-VETERANS
Check coupon below

Both
Resident and
Home Study
Courses Offered!



NATIONAL SCHOOLS

Dept. RB-104
4000 S. Figueroa St., Los Angeles 37, Calif. or 323 West Polk St., Chicago 7, Ill.

GET FACTS FASTEST! MAIL TO OFFICE NEAREST YOU!

(mail in envelope or paste on postal card)

NATIONAL SCHOOLS, Dept. RB-104

4000 S. Figueroa Street Los Angeles 37, Calif. or 323 West Polk Street Chicago 7, Ill.

Send FREE Radio-TV Electronics book and FREE sample lesson. No obligation, no salesman will call.

NAME _____ BIRTHDAY _____ 19__

ADDRESS _____

CITY _____ ZONE _____ STATE _____

Check here if interested in Resident School Training at Los Angeles. VETERANS: Give Date of Discharge _____

IMPORT PAYS BIG!

S. I. MELLINGER
Exporter-Importer

NEW WORLD TRADE BOOM OFFERS BIG PROFIT OPPORTUNITY to ambitious Men and Women everywhere. I'll show you how you may Import Thousands of desirable products at low foreign prices for buyers in your locality at high U.S. Prices—how you can operate a world-wide mail-order Import-Export business from home whether you live in a big city, or small town.

S. I. Mellinger

HERE'S PROOF!

As startling first-hand proof I will send you an actual import from overseas, **AT MY COST**—something to see and use. Just mail me 25¢ in coin and I will rush you this Imported Melson Automatic cigarette lighter—made to retail in the U.S. at \$2. This magnificent import will convince you of the tremendous profits being made in World Trade.

START AT ONCE WITHOUT CAPITAL or previous experience. Fantastic profits are possible. My training also includes shipment to you of many sample imports from 'round the world.

GRASP THIS OPPORTUNITY TODAY! Send for your Melson Automatic cigarette lighter now and I will include full details that show you how to learn my Big Profit secrets of Import-Export—complete instructions that will put you on the road to a Profitable business of your own. Opportunity to travel abroad for profit and pleasure. I'll also show you how you can save many dollars on your own purchases of Clothes, Tools, Gems, Antiques, Watches, Cameras, China, Silks, Toys, etc. You can have the complete details FREE without ordering the lighter if you wish, but I would like to send you the Melson lighter as an actual demonstration of Import Values. Either way, mail coupon Now. Airmail reaches me overnight.

The Mellinger Co., Dept. A-25A, 1717 Westwood, Los Angeles, 24, Calif.

HERE'S MORE PROOF!

"We operate a profitable World Trade Business from our home... Thanks to MELLINGER."

Mr. and Mrs. Beke, N.Y.

MAIL COUPON NOW!

The Mellinger Co., Dept. A25A
1717 Westwood, Los Angeles 24, Calif.

Mr. Mellinger: Show me the big profits to be made through World Trade. I enclose 25¢ in coin. Send me one Melson Cigarette Lighter and your plan that shows me how to learn the secrets of World Trade. (No lighter without a coupon. Only one to a person.)
 Just send your FREE World Trade Plan.

Name _____ Age _____
Street _____
Town _____ Zone _____ State _____

(Continued from page 18)

Craftsman and Shop Notes Index

AUTOMOTIVE

- Plastic liner protects bottle from frozen washer solution.....189
- Reflective-tape "dim" sign inside rear window aids night driving209
- Stop-light switch on car dash provides rear "fog light".....232
- Replacing broken car-hinge pin.....236

FARM

- Identifying letters on milk can "painted" with soldering iron.226
- Knob on side of grain spout helps fill feed basket.....236
- Constant water supply for poultry provided by cistern and pump227
- Intercom between house and barn.....232
- Automatic cutoff on water pump prevents overflowing tank...236
- Concrete apron of machine shed used as outdoor workshop...236
- Fire extinguisher on farm tractor mounted within easy reach244

HOUSE AND HOME

- Shelf modified for magazines neatly stores back copies.....198
- Risers on basement stairs—help keep floor clean.....200
- Brass trivet.....201
- Lamp for vanity table also serves as night light.....205
- Flat filed on door-hinge pin removes cause of squeaking.....209
- Works salvaged from broken kitchen clock fitted in modern case.....209
- Coil springs provide tension to guide lines on blinds.....222
- Flush-tank sweating prevented by supplying heated water.....222
- Pegged smoking stand.....320
- Laminated bookrack.....332

HOUSEHOLD HINTS

- Wash surface with turpentine after using paint remover.....197
- Appliance cord coiled to keep it off floor.....198
- Rubber cemented to chinaware protects furniture finish.....198
- Cut waste by puncturing lemon.....200
- Inexpensive lumberyard molding used for picture framing....200
- Solving Home Problems—
- House plants will not be damaged from too much water.....202
- Samples of yarn to be matched.....202
- Scratches in finish of walnut furniture.....202
- A child's oversize rubber can be fitted snugly.....203
- Clothes poles will not slip on line.....203
- Towel bar on baseboard makes dustpan rack.....203
- Garbage can is anchored by driving pipe into ground.....203
- Egg can be removed with tea strainer.....203
- Blanket discomfort relieved.....203
- Rubber boots dried quickly with aid of hardware cloth.....204
- Acidproof plug in glass jug is rubber sink stopper.....212

MISCELLANEOUS

- Doorstops hold drawing board in tilted position.....197
- Fish "weighed" with tape measure.....198
- Washer held in hose connections by long straight pin.....198
- Eight valuable uses for blackboard erasers.....199
- Heat restores ball-point pen.....204
- Doghouse built under workbench heated by light bulb.....205
- Salt and pepper shakers for picnics.....205
- Plan of the month.....210
- Balloon-tired wheels for models formed from rubber ball.....212
- T-square used on blackboard to chalk parallel lines.....212
- Fiberglass-plastic on boat deck replaces painted canvas.....221
- Electric shaver quickly cleaned with discarded hairbrush.....222
- "Pressurized" protective hood keeps out paint spray.....226
- Ground rod reinforced by pipe.....232

(Continued to page 26)

IMPORTANT NOTICE—It is the intention of this magazine to provide its readers with information regarding the latest developments in the mechanical arts. We take no responsibility as to whether the disclosures contained in our articles are covered by patents and advise readers to investigate this subject before making, using, or selling any of the products, machines, or processes described in order to avoid possible liability for patent infringements.

Don't Be "BUFFALO-ED" by Any Car Repair!



USED BY ARMY AND NAVY

1,886,000 COPIES SOLD!

Whether You Are a Beginner or An Expert Mechanic
Motor's Brand New Auto Repair Manual Shows You
HOW TO FIX ANY PART OF ANY CAR

**MOTOR'S
AUTO
REPAIR
MANUAL**

Yes, Brakes, Clutches, Transmissions, Rear Ends, Carburetors, or Any Other Part
FASTER...EASIER...and RIGHT on the very first try!

DON'T let yourself be "buffalo-ed" by any car repairs! Now you can tackle even the tough jobs with confidence. Yes, now it's easy as A-B-C to fix any part of any car—whether it's a simple carburetor adjustment or a complete overhaul. Just look up the job in the index of MOTOR'S new AUTO REPAIR MANUAL. Turn to the pages and pictures referring to the job. Follow the clear, illustrated, step-by-step instructions. It's as easy as that! No guesswork! MOTOR'S Manual takes nothing for granted. Tells you where to start. What tools to use. Leads you easily, quickly through entire operation. **COVERS EVERY CAR BUILT FROM 1940 THRU 1954!**

2950 Pictures! So Complete So Simple, You CAN'T Go Wrong!

BRAND-NEW, REVISED edition! ONE THOUSAND giant pages. 2950 "This-is-how" pictures lead you every step of the way. Over 230 "Quick-Check" charts — 22,500 essential repair specifications. Over 225,000 service and repair facts. So clear you can't go wrong! Even a green beginner mechanic can do a good job with this giant guide before him. And if you're a top-notch mechanic, you'll be amazed by the time and labor-saving factory methods!

The "Meat" of Over 140 Official Shop Manuals

The editors have put together the "know-how" from over 140 Official Shop Manuals, hundreds of service bulletins; "balled it down" into one fully-illustrated easy-to-understand guide. We just can't begin to cover the vast contents of this giant book. You must see it to realize its value. That's why we make this FREE-TRIAL offer:

SEND NO MONEY

Try Book for a Week FREE

Send no money. Pay nothing to postman. Test book in your own garage or shop. It's **GUARANTEED** to pay for itself in 7 days. If it doesn't, just return the book, and owe nothing. Rush coupon for FREE-Trial copy. MOTOR Book Dept., Desk 1K, 250 W. 55 St., N.Y. 19, N.Y.

Same FREE 7-DAY Offer on MOTOR'S New TRUCK AND TRACTOR REPAIR MANUAL
Covers EVERY job on EVERY popular make gasoline truck, tractor made from 1945 thru 1954—including GM and Cummins Diesels. Over 2,200 illustrations; 200 Quick-reference charts; 850 pages. FREE 7-Day Trial. Check proper box in coupon.



2 of Many Letters



Has Paid for Itself Time and Again—"It's easy to see close-up pictures of every part. It has paid for itself time and time again."

P. R. Pewee, Tripoli, Wis.
"I amazed myself and my friends too. Now do jobs that stumped me before."



685 MODELS—ALL THESE MAKES

- | | |
|-----------|------------|
| Buick | Kaiser |
| Cadillac | Lincoln |
| Chevrolet | Mercury |
| Chrysler | Nash |
| De Soto | Oldsmobile |
| Dodge | Packard |
| Ford | Plymouth |
| Frazier | Pontiac |
| Henry J | Studebaker |
| Hudson | Willis |

**FREE
7 DAY TRIAL**

Return and Pay Nothing if Not Satisfied!

MAIL COUPON NOW FOR 7-DAY FREE TRIAL

MOTOR BOOK DEPT., Desk 1-K,
250 West 55th Street, New York 19, N. Y.

Rush to me at once: (Check box opposite book you want)

MOTOR'S New AUTO REPAIR MANUAL. If O.K. I will remit \$2 in 7 days, then \$2 monthly for 2 months, and a final payment of 35c (plus 35c delivery charge) a month later. Otherwise I will return book postpaid in 7 days. (Foreign price, remit \$5 cash with order.)

MOTOR'S New TRUCK & TRACTOR REPAIR MANUAL. (Described at left.) If O.K. I will remit \$2 in 7 days and \$2 monthly for 3 months, plus 35c delivery charge with final payment. Otherwise I will return book promptly. (Foreign price, remit \$10 cash with order.)

Print Name..... Age.....

Print Address

City & Zone No..... State.....

SAVE 35c delivery charges by enclosing WITH COUPON order for full payment of \$6.95 for Auto Manual (or \$8.00 for Truck Manual). Same 7-day return-refund privilege applies.

Sample of Giant Book's Contents:

- | | | | |
|---|--|---|---|
| Tune Up — Tells, step-by-step, how to get smooth engine performance with fuel economy. | Ignition System, Generator, Generator Regulators — Removal, disassembly, installation and timing — functions, inspection, service requirements of all parts of ignition. | Starting Motors — Removal, disassembly, inspection, repair, installation. | Fuel Pumps — Engine Service Cooling System Clutch |
| Transmissions | Air Conditioning | Overdrives | Wheel Alignment |
| Front End | Suspensions | String Gears | Rear Ends |
| Brakes | Power Brakes | Power Steering | Power Tops |
| Window Lifts and Seat Adjusters | Automatic Chokes | Shock Absorbers | Universal |
| Specifications on: Pistons and Rings; Valves; Engine Bearings, Brakes, Wheel Alignment, Rear Axle, Lubrication, Capacity, Generator, Distributor, Generator Regulator, Starting Motor, Carburetor, PLUS MUCH MORE | | | |

Stay on the BALL with GOODHEART-WILCOX Books

- ALL ABOUT HOUSE WIRING**
New how-to-do-it book covers all phases of MODERN house wiring. Takes "mystery" out of house wiring. Tells how to determine exactly what wiring is needed; shows in 192 crystal clear drawings, EASY way to do all kinds of wiring jobs in both new and old homes. \$2.50
- PRACTICAL CARPENTRY**
1100 illustrations. Complete house construction details from staking out lot to interior trim. Valuable on-job assistant for apprentices, home owners who do own repairing, remodeling. Even experienced carpenters find this mammoth book of priceless facts helps them make work easier; enables them to handle jobs they wouldn't tackle before. . . \$5.00.
- FIX YOUR FORD**
Combined know-how of hundreds of top Ford service men. Covers V-8's and 6's 1932 to 1951. How to make Fords run better, faster, longer, safer, worth more. If you drive a Ford you need this book . . . \$2.50.
- MOTOR SERVICE'S NEW AUTOMOTIVE ENCYCLOPEDIA**
Complete course in auto mechanics with special emphasis on fundamentals, trouble shooting, adjusting, repairing. All information needed to fix all parts of all cars built past 25 years. Also includes tractors, motorcycles, gas, diesel engines . . . \$7.95.
- AUTO REPAIR KINKS**
Covers 20 popular cars, Buick to Willys. Hundreds of kinks (unusual time and money-saving shortcuts) that have helped mechanics out of tight spots. \$1.00.
- AUTO MECHANIC MANUAL ON BRAKES & STEERING** (including wheel alignment). Describes operation of natural and mechanical forces in easy-to-understand form. Real "gospel" by an expert . . . \$3.50.
- MODERN ELECTRIC AND GAS REFRIGERATION**
Covers repairs, adjustments, overhauling domestic, commercial equipment. Most helpful and biggest selling book on refrigeration. . . \$5.00
- MODERN WELDING PRACTICE**
Up to date encyclopedia of welding information. Covers all types of gas, electric welding, heat treating, cutting . . . including submerged arc, inert gas welding, etc. . . \$5.00.
- BAILEY'S HANDBOOK FOR ENGINEERS AND FIREMEN**
Questions and answers on boilers, pumps, heating equipment, air conditioning, refrigeration, marine, diesel engines, etc. . . \$2.75.
- ALL ABOUT POWER TOOLS**
New book gives step-by-step procedure on using 14 different workshop machines Efficiently and Safely. Using power tools properly will enable you to bring forth skills you never dreamed you had . . . \$1.00.
- SHOP ARITHMETIC**
Simplified way to learn mathematics you need in your work . . . \$1.50.
- SHOP GEOMETRY, ALGEBRA AND TRIGONOMETRY** . . . \$1.75.
- YOU CAN GROW MORE CORN**
Brings together ideas that will make you money . . . \$3.50.
Check books you want, clip this ad and mail with check; money order; U. S. or Canadian currency, carefully wrapped. PROMPT REFUND if not completely satisfied.

GOODHEART-WILCOX CO. Chicago 5, Ill.
Dept. 220 1321 S. Michigan Ave.

BUILD WITH CRAFTPLAN PATTERNS

27 SHELVES, SHADOW BOXES. All necessary patterns, details on 19 easy-to-make shelves, 8 shadow boxes . . . a shelf for every need. \$1.50

14 Designs ACTION WINDMILLS. All kinds of life-like action. Farmer milking cow, woodpecker pecking on a tree. Kit of 14 full-size patterns. \$1.00

8 MAGAZINE RACKS. Full size patterns on 8 practical magazine racks. \$1.50

14 COLORFUL FLOWER BOXES. Full-size patterns on 14 nifty boxes for plants. \$1.00

20 Things to Make for CHILDREN \$1

22 RACKS, CABINETS, KITS For Sewing Accessories. All the patterns needed to make 22 useful items. \$1.00

Costume Jewelry from Wood and Plastics. 452 full-size patterns. \$1.00

13 Easy-To-Build Workbenches. Sturdy, well-designed benches. \$1.00

27 BIRD HOUSES FEEDERS
Everything from small wren house to elaborate colony houses for martins. 27 plans. \$1.00

30 Smart Lamps
How to make at small cost. \$1.50

16 Book Ends
Full-size patterns. \$1.00

56 Worth of Plans for \$5
If price of plans is \$5.00 we'll include without extra charge another dollar's worth of plans of your selection. Check plans wanted, clip ad, mail with remittance. **SATISFACTION GUARANTEED.**

1321 S. Michigan Dept. A-245 Chicago 5

1432U

JESUS SAVES Religious Mottoes Full-size patterns on eight inspiring mottoes and 4 beautifully lettered Lord's Prayer. \$1.00

22 Full-Size Patterns UNUSUAL LAWN NOVELTIES \$1.50

Personalized HOUSE, LAWN MARKERS
Make house or lawn marker with your name or address, 17 silhouette patterns. \$1.00

129 JIGSAW PATTERNS—Lawn ornaments up to 22 in., games, gifts, etc. \$1.00

SANTA AND BABY DEER
Colorful Christmas lawn decoration. \$1.00

Carol Singers
Tallest cut-out 37 in. \$1.00

Old Santa Cutout
Full size pattern 5 ft. high. \$1.00

Patterns on 15 Fast Action Toys \$1.00

(Continued from page 24)

PHOTOGRAPHY

- Multipurpose tool for darkroom provided by wiper blade. . . . 197
Nail and cork over clock face provide emergency timer. . . . 200
Preheated ferrotype plates reduce print-drying time. . . . 200
Photo prints straightened with rubber pad and dowel. . . . 217
Blow dust from your negatives. . . . 222

TOOLS

- "Floating" lathe holder for drilling or reaming. . . . 227
Faceplate-center indicator speeds job setup. . . . 232
Shopping for Tools—
Leakproof oiler (The Hughes Co., 3 W. 40th St., New York City 18). . . . 242
Power-driven trowel (Master Vibrator Co., 1752 Stanley Ave., Dayton, Ohio). . . . 242
Motor mount (Duro Metal Products Co., 2561 N. Kildare Ave., Chicago 39). . . . 242
Portable tree saw (Mall Tool Co., 7740 S. Chicago Ave., Chicago 19). . . . 242
Portable electric jigsaw (Dalton Mfg. Co., 20 S. Central Ave., St. Louis [Clayton] 5, Mo.). . . . 242
Back stand (Design Associates, 1924 Greendale Ave., Park Ridge, Ill.). . . . 243
Hole cutter (Hartmeister, Room 8, 2020 W. Barry Pl., Denver, Colo.). . . . 243
Double hacksaw (Drier Brothers, Inc., 5642 Lake Park Ave., Chicago 37). . . . 243
Bench milling machine (Precise Products Corp., 1328 Clark St., Racine, Wis.). . . . 243
Flaring tool for copper tubing improvised from steel rod. . . . 244
Tin cans fitted over jar lids provide lathe-chuck storage. . . . 244

WORKSHOP HINTS

- Leather sheath covers exposed blade of ax. . . . 197
Angle cut on ornamental molding provides guide line for coping 197
Chalk line stretched with bow permits accurate marking. . . . 200
Extra blades for carving tools from injector-razor blades. . . . 204
Powder puff chucked in drill utilized as buffing wheel. . . . 204
Guards protect wood surface against screwdriver damage. . . . 204
Round typewriter eraser provides abrasive disk. . . . 204
Holder prevents hand injury when using cold chisel. . . . 212
Drum attached to belt sander provides dual-purpose machine. . . . 221
Wood filler mixed as needed. . . . 222
Disposable tissues in workshop provide safety factor. . . . 226
Sliding handle used as jack to level heavy machinery. . . . 226
Removal of broken handle. . . . 227
"Bumper" on drill-press column protects operator against injury 236
Push stick for bench saw. . . . 236
Chain hooked to out-of-reach eye with aid of hose extension. . . . 244
Tubing cut in "miter block" made from hardwood cube. . . . 244

Scientists Skin Dive for Oil

Skin-diving geologists operating off the California coast are turning up evidence that may lead to major oil discoveries. Clad in bathing trunks and aqualungs, a six-man team known as the Geological Diving Consultants of San Diego has already discovered deposits of phosphorite and manganese. The scientists have also discovered oil seeps that vary in size from trickles to extensive underwater tar pits—even exceeding in size the famous La Brea Tar Pits of Los Angeles. "Thousands" of gas seeps have been discovered during the explorations. The hardy group, which operates at depths ranging down to 150 feet, has made more than 1000 dives for local oil companies since its formation late last year.

**It's New! 3 Years in Development
-NOW READY FOR YOU!**



This is the new Sprayberry Training Television Receiver.

You build the new Sprayberry Tester... 18-range Volt-Ohm-Milliammeter readings.

**17" to 24"
PICTURE TUBE**



You will build this powerful short wave and broadcast superhet radio receiver.

New Equipment! New Lessons! Enlarged Course!
SPRAYBERRY PRACTICAL TRAINING IN
RADIO-TELEVISION

3 NO OBLIGATION TRAINING PLANS



F. L. SPRAYBERRY
Pres.

You have NO MONTHLY PAYMENT CONTRACT to sign... pay for this outstanding training as you learn!

Mail the coupon at once for my big all-new 56 page FREE CATALOG and FREE Sample Lesson. Get the full story of this remarkable new Training Plan. Read about my 3 NO OBLIGATION PLANS of "packaged unit" instruction. I can prepare you in as little as 10 MONTHS to take your place as a Trained Radio-Television Technician. You take no risk in enrolling for my Training because you DO NOT SIGN A BINDING TIME PAYMENT CONTRACT. I have been training successful Radio-TV technicians for 22 years...I can prepare you, too, to get into your own profitable Service Shop or a good paying job. Full information FREE and without any obligation. No salesman will call.

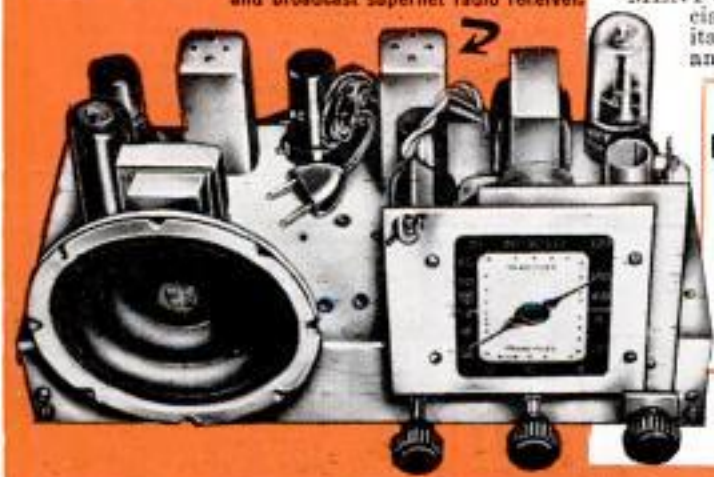

NEWEST DEVELOPMENTS

Your training covers U H F, Color Television, F.M., Oscilloscope Servicing, High Fidelity Sound and Transistors.

PRACTICE AND TRAIN AT HOME WITH 25 NEW KITS of EQUIPMENT

You get valuable practical experience in construction, testing and shop practice. You build a powerful 2 band superhet radio, the all-new 18 range Sprayberry multimeter, the new Sprayberry Training Television receiver, signal tracer and many other projects. All equipment is yours to use and keep. All your training is IN YOUR HOME in spare hours. I help you earn extra spare time money while you learn. Rush coupon below for all the facts—FREE!

SPRAYBERRY ACADEMY OF RADIO
111 NORTH CANAL STREET, DEPT. 10-P
CHICAGO 6, ILLINOIS



FREE CATALOG AND SAMPLE LESSON

Rush coupon for my catalog "How to Make Money in Radio-Television". PLUS an actual sample Sprayberry Lesson without obligation—ALL FREE. Mail coupon NOW!

SPRAYBERRY ACADEMY OF RADIO MAIL THIS COUPON FOR FREE Dept. 10-P, 111 N. Canal St., Chicago 6, Ill. FACTS AND SAMPLE LESSON Please rush New Catalog and Sample Lesson FREE. I understand that no salesman will call.

Name _____ Age _____
Address _____
City _____ Zone _____ State _____



**YOU
can
acquire**

LAW NIGHTS AT HOME! L. B. DEGREE

LaSalle's famous Law Library—used as reference in many Law libraries and Law offices—has enabled thousands to master Law surprisingly fast, in spare hours at home, for business and professional advancement.

These 14 remarkable volumes, compiled by leading professors and lawyers, cover the whole basic field of Law in condensed, orderly, simplified manner.

You advance rapidly with this great library, plus special lectures furnished. We guide you step-by-step with personalized Problem Method of instruction . . . you learn by doing—handling legal problems—not by memorizing rules.

Send for two FREE 48-page booklets, "Law Training for Leadership," and "Evidence," answering questions about Law and its value to you, and telling how LaSalle Law graduates are winning rapid advancement in business and public life. Mail coupon below. No obligation.

LA SALLE EXTENSION UNIVERSITY A Correspondence Institution

417 S. Dearborn St. Dept. 1064L Chicago 5, ILL.

Send me your two FREE booklets described above; without obligation.

Name.....Age.....

Street.....

City, Zone & State.....

ENGINEERING DEGREE IN 27 MONTHS

Big Demand for Graduates

Aeronautical, Chemical, Civil, Electrical, Mechanical and Radio Engineering (inc. TV and Electronics)

Hundreds of young men are earning B. S. ENGINEERING DEGREES annually in this recognized institution — year around operation. New terms start quarterly. Many students earn a major part of their college expenses in this large industrial center.

Low tuition. Competent instruction. Thorough, intense, practical program. Modern, well-equipped laboratories including new physics laboratory and modern wind tunnel. Individualized instruction emphasized.

Government approved for G.I.'s. Engineering preparatory courses. Students from 48 states and 21 foreign countries. Enter December, March, June and September. Send coupon for free catalog and full information. Enroll now.

SEND COUPON TODAY -

INDIANA TECHNICAL COLLEGE

5104 E. Washington Boulevard
Fort Wayne 2, Indiana

Please send me free information on B.S. Engineering Degree in 27 months as checked.

Aeronautical, Chemical, Civil, Electrical,
 Mechanical, Radio-Television

Name.....

Address.....

LOW OVERHEAD-LARGE VOLUME SALES & SMALL PROFITS
BRING YOU THESE "LOWEST PRICES."
WHAT GOOD IS A TIRE WITHOUT A TUBE?
TUBE FREE WITH EVERY TIRE AT NO EXTRA COST



**WHY PAY
MORE!**

21 YEARS AT THIS ADDRESS
AN ESTABLISHED POLICY OF CAREFUL SELECTION ASSURES YOU, MANY HAPPY MILES. BE WISE—TRY ONE—YOU'LL BUY MORE! WE WELCOME COMPETITION. NO ONE CAN TOUCH OUR QUALITY & PRICE!

GOOD USED TIRES — NOT RECAPS — NOT RETREADS
TAKE THE 10% DISCOUNT WE OFFER & PUT MONEY IN YOUR POCKET!
EVERYBODY MAY TAKE 10% off ON EVERY TIRE
15 MONTHS WRITTEN GUARANTEE

600-16 \$3.52	820-15 \$4.92	600-20 \$7.52	32x6-8) \$8.72
650-16 4.22	700-15 3.92	650-20 7.62	32x6-10) 10.72
700-16 4.42	670-15 4.02	700-20 8.82	900-20 13.22
650-15 3.82	710-15 4.32	750-20 8.52	1000-20 14.02
760-15 4.42	550-17 3.72	825-20 14.12	1100-20 16.82

FREE If you buy 2 or 3 PASSENGER, 30 mos. guarantee tires. We GIVE ONE tire **FREE**.

Specialists in Truck Tires—Selected for Toughest Jobs—Tops in Value		32 MOS. WRITTEN GUARANTEE	
600-16 \$5.02	475-19 \$5.12	700-15(6) \$8.42	700-20 \$10.62
600-16(G) 6.32	640-15 4.72	750-16(8) 8.42	750-20(10) 15.02
650-16 5.52	670-15 5.12	700-17 8.72	750-20(8) 12.72
650-16(G) 7.02	710-15 5.22	750-17 10.52	825-20 17.52
700-16 6.12	760-15 5.72	750-15 10.42	900-20 17.62
750-16(G) 8.32	800-15 6.02	825-15 10.92	1000-20 16.52
550-18 3.92	820-15 6.12	600-20 8.72	1100-20 17.02
550-17 4.22	670-16 5.02	650-20 9.52	1100-22 17.92
650-15 5.02	760-16 7.02	32x6-8) 10.52	1000-22 17.92
700-15 5.12	700-16(6) 7.12	32x6-10) 12.92	1100-24 22.92

DeLuxe WHITE WALLS \$1.00 extra

Thousands of tires shipped all over the U.S.A. All tires shipped F.O.B. Phila. Send Check or M.O. with this ad. Dept. 2, No C.O.D.
STANDARD 834 N. Broad St., Philadelphia 30, Pa.

SHORTHAND in 6 WEEKS

Famous SPEEDWRITING shorthand. 120 words per minute. No symbols; no machines; uses ABC's. Easiest to learn, write and transcribe. Lowest cost. 250,000 taught by mail. For business and Civil Service. Typing available. 32nd year. Write for FREE booklet to: SCHOOL OF

Speedwriting
Dept. 1510-4, 55 W. 42 St., New York 36 (R)

Become a Doctor of PSYCHOLOGY

Win the degree of Ps.D. Learn the secret of contentment, happiness. Solve mental worries. Experience the revelation of truth. Chartered college. Individual help. Write for FREE book. COLLEGE OF UNIVERSAL TRUTH, 5038-B Broadway, Chicago.

Print Your Own
Cards, Stationery, Advertising, labels, circulars, photo and movie titles, church work, tags, etc. Save money. Sold direct from factory only. Raised printing like engraving, too. **Print for Others, Good Profit.** Have a home print shop. Easy rules supplied. Pays for itself in a short time. Write for free catalog of outfits and all details.
KELSEY PRESSES, N-37 MERIDEN, CONN.

Say You Saw It in Popular Mechanics

you can be
TALLER
too, in
"ELEVATORS" do so many wonderful things for you. You slip on a pair and grow almost 2 inches taller at once. It's amazing . . . because they look and feel just like any other fine quality shoes you've ever worn. 15 styles for street, sport, dress

THE ORIGINAL AND GENUINE
ELEVATORS
WEIGHT-INCREASING SHOES
"YOUR PERSONAL PINSTACLE"
IN TRADE MARK BY STONE-TARLOW CO., INC.

FREE BOOKLET
Write

STONE-TARLOW CO., INC. DEPT. P M, BROCKTON 68, MASS.

I Average \$20-\$25 Profit An Hour—Over \$100 a Day!



"For Easy and Profitable Selling PRESTO Can't Be Beat"
 "Presto is the easiest selling and most profitable item I have ever sold or seen. My selling time actually shows me a profit of \$20.00 to \$25.00 per hour and I have yet to put in a 6-hour day without showing a profit of over \$100.00."
 —M. R. Stanley, Montreal

Made \$175 in First 5 Days

"My first week my profit was \$175.00 for the 5 days. I have hit as high as \$44.00 profit in one day. Every sale is a thrill. I am certainly pleased and happy as it is the most and easiest money I ever made in my life."

—Cordian S. Melious, New York C. S. Melious



AVERAGES \$15.20 An Hour

"The 'natural' of this decade is the PRESTO FIRE EXTINGUISHER . . . because it is handy in size, simple to operate, and in the right price range. For every hour I have devoted to PRESTO I have earned an average of \$15.20 an hour."

—William F. Wydalis, Ohio



W. Wydalis



S. Hyman

Made Over \$1000 a Month—Calls Sales "Automatic"

"PRESTO is the fastest money-maker ever produced. If a man demonstrates intelligently, sales follow automatically. I have made an excellent living with the PRESTO, having made over \$1000 a month."
 —Stanley Hyman, New York

Made \$28.35 in 3 Days

"Presto is great! I made \$28.35 in 3 days, working only part time! Then I reconsidered, I should have reentered immediately, and my profits would have been greater. I won't run out of Prestos again! When they see Presto actually put out a fire, everyone wants it!"
 —Glen E. Herbert, Missouri



Glen E. Herbert

"At Least \$20 a Day"

"I am selling a greater service at a lower cost than has ever been possible before. Every demonstration is a thrill and keeps me interested so that selling does not become monotonous. I really make \$20, at least, every day I work."
 —H. J. Kerr, Pennsylvania



H. J. Kerr

Sells Average of 100 PRESTOS a Week—Part Time

"PRESTO is in a class by itself, small, but mighty, easy to handle, good on any kind of fire. My biggest week—two gross. My average sales on part-time basis—100 a week. Real salesmen putting in 8 hours a day can make a real week's pay selling PRESTO fire extinguishers."
 —R. H. Taber, New Hampshire

R. H. Taber

R. H. Taber

Over \$10 Profit an Hour—In Spare Time

"Unfortunately, I am unable to devote my full time to this remarkable line. To date I have put in 5 1/2 hours of work—at a profit to me of over \$10 an hour!"

—Hugh Sedler, New Jersey

No Sales Experience—Made Over \$1000 a Month!

Charles Kama of Texas had NO sales experience until he took up PRESTO. He did so well that he was featured as "Salesman of the Month" in a national sales magazine. In an interview he said: "I think I've succeeded pretty well. I'm making more than \$1000.00 a month—and I haven't touched bottom yet."



C. Kama



H. Sadler

WHO ELSE WANTS TO MAKE A WEEK'S PAY IN SINGLE DAY!

Men From Coast to Coast Are Making Money "Hand Over Fist" Showing Science's New "Midget Miracle" Presto Fire Extinguisher OVER TWO MILLION ALREADY SOLD!

WOULDN'T YOU like to be making the kind of money these men are making? Their stories (printed above) are examples of the brilliant success that Presto salesmen are enjoying. If so many men—some of them without previous sales experience—are doing so well, it proves that Presto is a "natural"—a red-hot product that ACTUALLY SELLS ON SIGHT!

What Is the Secret?

Presto contains an amazing new chemical—"Chlorobromomethane" or "C.B." The Germans developed "C.B." as a secret defense against fire during the war. After the war, a famous American firm, the Dow Chemical Company, acquired the formula from the U. S. Government and began manufacturing it here. Then we (Merlite Industries) designed a handy—yet amazingly effective—fire extinguisher to contain and release this new wonder-chemical.

So Easy to Handle!

In comparing the effectiveness of "C.B." in fighting various kinds of fires an authoritative testing laboratory's report states: "It has been proved that 'C.B.' is about 1.5 to 6 times as effective as other common extinguishing agents on an equal weight basis."



PRESTO contains "C.B." (Chlorobromomethane), the same chemical the U. S. Air Force specifies for fire-fighting in B-29s, B-50s and other U. S. aircraft. No wonder Presto puts out fires in as little as 2 seconds and is called Science's "Midget Miracle."

This extra effectiveness of "C.B." means that Presto can be made light and handy enough for even a woman or child to use. Just a twist of the knob . . . and flames disappear! "Sells on sight" to Civil Defense workers, owners of homes, cars, stores, farms, service sta-

tions, boats, motorcycles, factories, offices . . . and to stores for re-sale.

Why Large Presto Profits Are So Easy

Everyone is terrified at the very thought of FIRE! Every year fire kills more than 11,000 people—destroys over SEVEN HUNDRED MILLION DOLLARS in property. Millions of people have been waiting for this sure, simple, inexpensive safeguard.

Most people who see Presto in action want one or more—ESPECIALLY WHEN THE PRICE IS ONLY \$3.98 EACH! We give you dramatically powerful printed sales material to "talk from" . . . free certificates testifying that Presto is GUARANTEED FOR 20 YEARS!

Advertised in Life and Other National Magazines

YOU DON'T NEED TO INVEST A CENT! Just collect and keep \$1 or more every time you write an order—we collect balance and make delivery. (Or you can buy from us at extra-low wholesale prices and make up to \$2.18 per unit—we'll send you details.)

Get Started Now . . . MAIL COUPON

Get started in this rich new field now. Don't put it off. Every day you hesitate may cost you \$10, \$15, or even \$50 you could otherwise be making. Mail coupon NOW for everything you need to get started right away!

MERLITE INDUSTRIES
 Dept. 510, 114 E. 32 St.,
 New York 16, N. Y.

Folks Are Amazed When You Tell Them This New Kind of Protection Costs Only \$3.98



Science's New "Midget Miracle" Over Two Million Already Sold!

MERLITE INDUSTRIES, Dept. 510, 114 East 32nd St., New York 16, N. Y.

Please send me illustrated sales literature, liberal profit plan, order blanks—everything I need to start making good money introducing Presto in my locality.

CHECK HERE IF YOU WISH TO ORDER A REGULAR PRESTO TO BE USED AS A DEMONSTRATOR (\$2.50).

Check here if you wish to order a double capacity PRESTO to be used as a demonstrator (\$3.75). Pay for themselves many times in increased sales. Can be returned as often as necessary for FREE refills. Send no money—we'll mail C.O.D. (Or enclose check or M.O. and WE will pay postage. Money back, if not delighted.)

Name _____

Address _____

City _____ Zone No. _____ State _____
 IN CANADA: Mopa Co., Ltd., 371 Dowd St., Montreal 1, P.Q.

BECOME AN Electrical Engineer



- Major in Electronics or Power
- Earn B. S. Degree in 36 Months

Over 50% of the nation's industrial leaders began their careers with engineering training. Prepare now for a rewarding future as an Electrical Engineer or Engineering Technician. Enroll at the Milwaukee School of Engineering.

Plan Your Career — Eight Courses Give You Wide Range of Study

ENGINEERING COURSES

Electrical Engineering-Bachelor of Science Degree
Save a valuable year through optional year 'round study.
Electronics major36 months
Power major36 months

TECHNICIAN COURSES

Electro Technician12 months
Electronic Technician12 months
Radio Technician12 months
Radio and Television Technician18 months

SERVICE COURSES

Electrical Service6 months
Radio and Television Service12 months

MECHANICAL TECHNOLOGY

COURSES — Also available, Service and Technician courses 6 to 18 months — Heating, Refrigeration, Welding, Air Conditioning and Mechanical — B.S. Degree in Mechanical Engineering with a major in Design, Metal Fabrication, or Plant Engineering.

Also, general 3-month preparatory course.

Terms open January, April, July, September. Approved for veterans. Prior Military, Practical or Academic training evaluated for advanced credit. Faculty of specialists. 50,000 former students. Annual enrollment from 48 states and 23 overseas countries. 51st year. Non-profit. Residence courses only. Send handy coupon today.

MS-11A



MILWAUKEE

SCHOOL OF ENGINEERING

MILWAUKEE SCHOOL OF ENGINEERING
Dept. PM-1054, 1025 N. Milwaukee St., Milwaukee, Wis.

Send free illustrated career booklets Electrical Technology Mechanical Technology Radio-Television.

I am interested in.....
(name of course)

Name.....Age.....

Address.....

City.....Zone.....State.....

If veteran, indicate date of discharge.....

Shrinks Hemorrhoids New Way Without Surgery

Science Finds Healing Substance That Relieves Pain—Shrinks Hemorrhoids

For the first time science has found a new healing substance with the astonishing ability to shrink hemorrhoids and to stop bleeding—without surgery.

In case after case, pain was relieved promptly. And, while gently relieving pain, actual reduction (shrinkage) took place.

Most amazing of all—results were so thorough that sufferers made astonishing statements like "Piles have ceased to be a problem!"

The secret is a new healing substance (Bio-Dyne®)—discovery of a world-famous research institute.

Now this new healing substance is offered in ointment form under the name of Preparation H.* Ask for it at all drug stores—money back guarantee.

*Trade Mark



BIG DEMAND FOR ANIMATORS!

LEARN

ANIMATED CARTOONING

EARN
\$15,000
YEARLY!

Big Pay Jobs open in TV cities!
FREE Booklet on Home Study Courses!

ANIMATED CARTOONING SCHOOL OF AMERICA
STUDIO M BOX 2109 HOLLYWOOD 28, CALIF.

Learn ACCOUNTING

Business Administration

Bookkeeping, secretarial and allied subjects at home in your spare time or attend nationally approved resident school. Write for FREE Success Book giving complete details on courses, plans, rates and employment opportunities. G.I. approved.

Hills BUSINESS UNIVERSITY AND EXTENSION SCHOOL
619 W. MAIN ST. OKLAHOMA CITY 2, OKLAHOMA

WATCHMAKING

Learn at home • FREE sample lesson • Approved for Vets.
CHICAGO SCHOOL OF WATCHMAKING
2330 N. MILWAUKEE AVE., DEPT. 1104A, CHICAGO 47, ILL.

REAL ESTATE

BE A BROKER

PAYS BIG! SEND FOR FREE, BIG, ILLUSTRATED CATALOG NOW! Graduates report making substantial incomes. Start and run your own business quickly. Men, women of all ages, learn easily. Course covers Sales, Property Management, Appraising, Loans, Mortgages, and related subjects. STUDY AT HOME or in classrooms in leading cities. Diploma awarded. Write TODAY for free book! No obligation.

Approved for World War II and Korean Veterans
WEAVER SCHOOL OF REAL ESTATE (Est. 1936)
2020 Grand Dept. PM Kansas City, Mo.



TELEPHONES

Desk Stand Style
Slightly used but in excellent condition
Many Valuable Uses
Inter-House Phones House to Barn, etc.
Loud Speakers Microphones
Educational Purposes, Toys, etc.

Complete, ready to use with wiring diagrams included. Two complete for only \$5.00 \$2.75 Postpaid in U.S.A.

TELEPHONE LAMP KIT — with illustrated instructions for making Desk Telephone Lamp including all parts (harp, nipples, push switch, cord, plug, etc.) \$6.50 Ppd. (Shade is not included).

MICROPHONE, Dept. X-1902, 1760 W. Lunt Ave., Chicago 26, Ill.

THIS 39½¢ STORM WINDOW

protects your family all winter!

INSTALL IN 5 MINUTES

SAVE \$100 OR MORE!

JUST PRESS ON—That's All!

• NO NAILS • NO HOOKS • NO SCREWS • NO TOOLS

Imagine a storm window that weighs less than 8 oz.—yet seals out wintry blasts and humidity like magic! **FLEXIBLE**—you can punch it, kick it, even tap it with a hammer and it springs back—never shatters! This amazing new type storm window is as **TRANSPARENT** as **CLEAR GLASS**! Not affected by snow, sleet, rain, dampness, because it is **100% WATERPROOF**.

LOW-COST HEALTH PROTECTION!



You can hardly see this **TRANS-KLEER** storm window—it's wonderfully transparent, yet it protects your loved ones from winter's frigid blasts. And each window costs only 39½ cents each!

Resists climate changes—won't crack even at 25 degrees **BELOW** zero! Will pass any and all Fire Department tests! To install, just press on with dual-purpose Adheso border—no nails, no screws, hooks or tools. Costs you only pennies, yet you can use and re-use it year after year for winter protection and comfort!



TRY ONE AT OUR RISK!

Over 1,000,000 of these new type storm windows were sold last winter alone. We invite you to try one, too, entirely at **OUR RISK**—no obligation whatsoever for you! When you've **TESTED** it—when you see how easily and quickly it goes on, you'll never again use the heavy, bulky, old fashioned kind! No more backbreaking installation! No more broken glass! It's a new, safe, sure way to winter comfort—for only pennies per window. **TRANS-KLEER** comes in rolls 36 inches by 432 inches—**ENOUGH FOR 10 AVERAGE SIZE WINDOWS, AT ONLY 3.95—HARDLY 39½¢ EACH!** In all, you receive **108 SQUARE FEET!**

PROVE IT YOURSELF WITH THIS SIMPLE MATCH TEST!

Try this: on a windy day, hold a lit match just inside a **CLOSED** window. The first strong gust of wind will blow it out. **NOW** put up a **TRANS-KLEER** window . . . you'll find that a lit match will **NOT** blow out **EVEN IF YOU KEEP YOUR REGULAR WINDOW OPEN!** No wonder so many have been sold! No wonder so many home owners, hospitals, farmers, buildings and churches are switching to **TRANS-KLEER!** To avoid disappointment, rush your order **NOW**—while our supply lasts! **SEND NO MONEY.** Simply fill in coupon and mail at once. Pay postman only **3.95** plus a few cents postage. Try a window for 5 days—test it. If not delighted, return the other 9 for **FULL REFUND.** **SPECIAL OFFER FOR BULK BUYERS: 6.90** for 2 full rolls (216 sq. ft.); **18.00** for 6 rolls; **34.00** for 12 rolls. **ACT NOW!** Mail the coupon **TODAY!** (CANADIANS: avoid tariff. Send direct to Thoresen Co., Dept. 6-LB-47, 45 St. James St. W., Montreal 1, P.Q.)

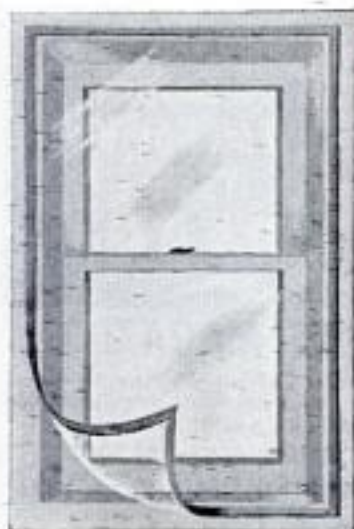

Lift Adheso Border For Airing!

So simple! So quick! Just lift border for airing of rooms. Just **ANOTHER** feature of **TRANS-KLEER** windows—usually **NOT** found in others!

5 WAYS BETTER!

1. Glasslike transparency. Not milky or cloudy.
2. Low conductivity—new Reynalon development.
3. Waterproof and Fire Retardant.
4. Climate resistant—even at 25 below zero.
5. Re-usable year after year.

THORESEN'S, Dept. 6-LB-47
352 Fourth Ave., New York 10, N. Y.

RUSH _____ rolls **TRANS-KLEER** at **3.95** each. (2 rolls—**6.90**; 6 rolls—**18.00**; 12 rolls—**34.00**). I understand one roll is enough for 10 windows, or 108 sq. ft. I will pay cost plus postage on arrival. I will try one **FREE**. If not delighted, I will return 9 remaining windows for full refund within 5 days. Include Adheso borders at no extra cost.

Name _____

Address _____

City _____

* **SAVE POSTAGE** by sending payment with order. In that case, we pay **ALL POSTAGE** to your door. Same money-back guarantee.

Check the Kind of Body You Want



Charles Atlas

... and I'll Prove How EASILY You Can Have It!

Just tell me, in coupon below, the kind of body you want—and I'll give it to you SO FAST your friends will be amazed! "Dynamic Tension," my easy, 15-minutes-a-day method, will make your chest and shoulders bulge... arms and legs surge with power... your whole body feel "alive!"

FREE BOOK 32 pages on how "Dynamic Tension" changed me from a 97-pound weakling into "World's Most Perfectly Developed Man"—and how I'll prove it can change YOU too. Mail coupon NOW!

CHARLES ATLAS, Dept. 8K, 115 East 23rd St., New York 10, N. Y.

Dear Charles Atlas: Here's the Kind of Body I want: (Check as many as you like)

- | | |
|--|--|
| <input type="checkbox"/> More Weight—Solid—in The Right Places | <input type="checkbox"/> Powerful Arms, Legs, Grip |
| <input type="checkbox"/> Broader Chest, Shoulders | <input type="checkbox"/> Slimmer Waist, Hips |
| | <input type="checkbox"/> Better Sleep. More Energy |

Send me absolutely FREE a copy of your famous book "Everlasting Health and Strength"—32 pages, crammed with photographs, answers to vital questions, and valuable advice. No obligation.

NAME _____ AGE _____
(please print or write plainly)

ADDRESS _____

CITY _____ STATE _____

not everyone does as well, but E. O. Lockin, who started a business of his own, reports...

for 12 months I've averaged
\$800 PER MONTH INCOME—
most of it clear profit for me!

Many men have discovered how to be independent, to be free of bosses and layoffs. L. A. Eagles grossed more than \$200 his first week. Others report gross up to \$12,000 per year. How much you make depends largely on you. You need no special skill, no large investment.

No shop necessary. Our ELECTRIC RUG WASHER cleans rugs, carpets right on floor... helps to show their natural color and beauty. So efficient and safe, used by largest hotels and railroads.

You take no risk. Machines fully guaranteed.

Write for full information including how to make big profits in YOUR OWN business.

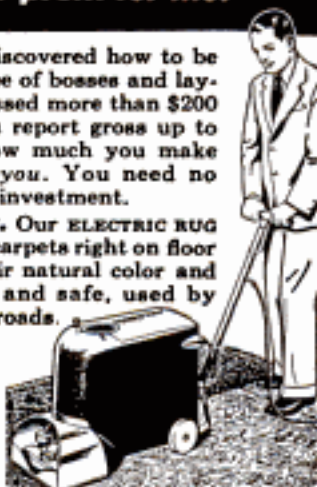

MAIL COUPON TODAY FOR FREE BOOK

Von Schrader Mfg. Co., N10 "R" Pl., Racine, Wis.

Without obligation, send your FREE booklet containing information about your ELECTRIC RUG WASHER and how I can start my own permanent, profitable business.

Name _____

Address _____

City _____ Zone _____ State _____

more jobs than graduates

ENGINEERS
If you are interested in these 11 pay you to write Box D, including a complete history of engineering and education.

Demand for our engineering graduates exceeds supply. Effective placement! Study in this world-famed college... established 1884. New term starts quarterly. Approved for Korean Vets.

Bach. Sc. degree in 27 months

Bachelor of Science in Mechanical, Civil, Electrical, Chemical, Aeronautical, Radio (Television), Administrative Engineering; Business Administration and Accounting. Also 36-weeks certificate courses in Surveying, Drafting, Secretarial Science. Intensive program: technical fundamentals accented. Small classes: personalized instruction. For earnest, mature students whose time and budget require accelerated courses and modest costs. Preparatory courses.

Beautiful campus in friendly college town. Well-equipped, new and modernized buildings and labs. Enter Jan., March, June, Sept. Write Jean McCarthy, Director Admissions, for Catalog and View Book.



TRI-STATE COLLEGE

4104 College Avenue Angola, Indiana

HERE'S A PROFITABLE BUSINESS FREE!

MONEY MAKING OPPORTUNITY FOR YOU WITHOUT INVESTMENT!

No experience needed to act as our Local Dealer for MASTER Work Uniform garments. Every business concern a prospect. Advertising embroidered on garments is a big sales feature. Stores can't compete. You can easily earn up to many thousands of dollars yearly. We supply all Sales Equipment FREE. Write **GEO. MASTER GARMENT DIV.** 279 WATER STREET, LIGONIER, INDIANA



TOOTHACHE? TOOTH GUM TOOTH DROPS POULTICE
Ask your Druggist for **DENT'S**

SHINE WITHOUT 'POLISH'

NEW Cars Glean Like Mirror

MEN! WOMEN! So easy a child can do it! Amazing "Dry" Polisher puts mirror-like shine on car WITHOUT 'POLISH'. No messy pastes, liquids, sprays. Simply glide over car. PRESTO! Leaves hard, lustrous, long-lasting protective Wax Coating. Take orders! Earn money!

SAMPLES FOR TRIAL
Sample offer sent immediately to all who send name at once. Just a postcard will do. SEND NO MONEY—just your name. KRISTEE CO., Dept. 678, Akron 8, Ohio



Before You Buy Your Trailer—**READ...**

TRAILER TOPICS MAGAZINE

It brings you the latest in Trailer Coaches—Equipment—Accessories—Trailer Trips—Trailer Parks and many other interesting monthly features at only—\$3.00 for 2 years.

(6 MONTH TRIAL SUBSCRIPTION \$1.00)

TRAILER TOPICS MAGAZINE (Room 1576)

28 East Jackson Blvd., Chicago 4, Ill.

At last! A New "How-To" Magazine covers the entire World of Electronics!

Not just TV . . . Not just Radio . . .
But a complete monthly encyclopedia of electronics for every hobbyist, every experimenter, every novice!

Tells how to do it!
How to build it!
How it works!
How to use it!

If you've ever wanted to equip your garage door for electronic-eye operation . . . or get into ham radio . . . or add radio controls to model trains . . . if you've ever wanted practical information on any phase of electronics . . . Then **POPULAR ELECTRONICS** is the magazine for you!



Everything for HOBBYISTS, EXPERIMENTERS, HAMS, STUDENTS!



HOBBYISTS! In no time, you'll build inexpensive electronic instruments, Hi-Fi systems, bike radios, light meters, hundreds of exciting electronic models. **POPULAR ELECTRONICS** makes it easy to do, even for beginners.



EXPERIMENTERS! Gain the most thorough knowledge and understanding of electronics the easy way through fascinating experimentation with transistors, meters, vacuum tubes, photo-electric cells.



HAMS! You'll learn how to obtain your novice ham license . . . how to build and operate your own station . . . you'll get into the world's most fascinating hobby!



STUDENTS! **POPULAR ELECTRONICS** shows you how to get more from your courses . . . teaches you how to use your knowledge for a practical and profitable career in electronics!

Just a few of hundreds of fully illustrated **POPULAR ELECTRONICS** features, month after month!

- THE EXPERIMENTER'S LABORATORY
- COMPONENTS USED IN ELECTRONICS
- HOW TO BECOME A RADIO HAM
- KIT OF THE MONTH
- HOW TO BUILD A BIKE RADIO
- MAKE THIS CODE PRACTICE SET
- GERMANIUM DIODE POWER FAILURE ALARM
- A PIE CASE RADIO
- HOW TO BUILD A LIGHT METER
- A CRYSTAL TYPE BROADCAST RECEIVER
- MEET THE TRANSISTOR
- TRICKS OF THE TRADE
- TIMING RELAY EXPERIMENTS
- REFLEX RECEIVER FOR THE BROADCAST BAND
- A CAPACITY OPERATED RELAY
- VOICE OPERATED MODEL TRAIN CONTROL

SUBSCRIBE NOW

WITHOUT RISKING A PENNY!

MAIL COUPON TODAY! REDUCED PRICE OFFER ENDS Dec. 30, 1954

POPULAR ELECTRONICS
366 Madison Ave., New York 17, N. Y.

GENTLEMEN: Please send me five issues of Popular Electronics for only \$1.00. If I am not delighted with the first issue, I understand you will refund my money on the unused portion of my subscription.

NAME _____

ADDRESS _____

CITY _____ STATE _____

ZIFF-DAVIS PUBLISHING COMPANY
Publishers of RADIO & TELEVISION NEWS
PHOTOGRAPHY • FLYING
366 Madison Ave., New York 17, N. Y.

DRAFTSMEN



**CASH BIG
PAY CHECKS!**

**Train Now for
more success,
greater security**

**LEARN AT HOME IN SPARE TIME
(or at college in Chicago)**

Check the want ads in any newspaper—SEE the big-pay opportunities open to you as a draftsman. What's more, you can learn this well-paid, prestige profession at home—quickly, easily! No special talent needed. Get complete, step-by-step Chicago Tech lessons in the mail, spend a few pleasant hours studying each week. In a short time you'll be a well-trained draftsman, ready to take your pick of many good jobs. Act now!



Free Information—Mail Coupon Today!

Get FREE TRIAL LESSON plus information about C.T.C. practical training. Learn what successful Chicago Tech graduates say about high pay and opportunities in drafting. No charge, or obligation.

CHICAGO TECHNICAL COLLEGE

N-252 Tech Bldg., 2000 So. Michigan Ave.
Chicago 16, Illinois

Mail me FREE lesson with facts about big opportunities in DRAFTING.

Name _____ Age _____
Address _____
City _____ Zone _____ State _____

BIG PAY JOBS for men who qualify in DIESEL



TRAIN NOW FOR A DIESEL FUTURE. Steady, high-pay jobs await men qualified in Diesel, Tractor, and Heavy Equipment. Are you qualified for job and advancement opportunities in this fast-growing field? You can qualify!

COMPLETE DIESEL COURSE NOW AVAILABLE. If you are ambitious and want to get ahead in this big money field, you'll want to know about the complete Diesel home training course now offered by Interstate Training Service. Covers all phases of operation, repair, service. Easy to master in spare time. No interference with present job. Up-to-the-minute. Regularly revised to cover new developments. We invite comparison of material offered. Advisory placement service for our students.

YOU OWE IT TO YOURSELF to investigate Interstate Training Service Diesel Training. Thousands agree it has helped them to better jobs...better pay. It can do the same for you!

WRITE FOR FREE INFORMATION TODAY

INTERSTATE TRAINING SERVICE, Portland 13, Ore.
Please see that I receive FREE 24-page book, (A-3-K)
"Getting Ahead in Diesel."

NAME _____ AGE _____
ADDRESS _____
CITY _____ ZONE _____ STATE _____



**Use my TESTED SALES
PLAN to make an extra
\$50.00 every week!**

Just a few hours each week—evenings, Saturdays—can add \$50 to \$100 to your regular income. Be a factory representative for Charles Chester patented Air-Cushion shoes—bring new comfort to friends, neighbors, co-workers—dress, work, leisure shoes for all the family sold *only* direct from factory to wearer. No investment is required—you make no deliveries, no collections. Just collect deposit from your customers; we do the rest!

STEADY AUTOMATIC REPEAT BUSINESS

Satisfied customers reorder constantly! CHARLES CHESTER representatives offer more than 140 styles, in a tremendous size range, 1-18, AAA to EEE. No Experience Needed—our tested, proven Sales Plan shows you how! Write today for details and FREE SALES KIT!



ALL-GRAB
SHOES



FREE
SALES
KIT!

CHARLES CHESTER SHOE COMPANY
3 Foundry St., Brockton, Mass.

AVIATION Pays You More With a Schooling at PARKS

NOW! A&E MECHANIC LICENSE COURSE

45-week course, all phases aircraft & engines. Enrollment Dates: Sept. 1-2, 1954, Jan. 3, 1955
FLIGHT COURSES—Private, Commercial, Instrument, Instructor, Multi-Engine.

DEGREE COURSES—B.S. degree in 3 yrs. from Saint Louis University—Aero. Engineering, Maint. Engineering, Aero. Administration.

All Parks Schooling Approved for Veterans
Write Today.

PARKS COLLEGE ARNOLD HALL
EAST ST. LOUIS, ILL.

"How to Make Money with Simple Cartoons"



A book everyone who likes to draw should have. It is free; no obligation. Simply address

FREE
BOOK

CARTOONISTS' EXCHANGE
Dept. 910A Pleasant Hill, Ohio

GROW MINIATURE TREES

Grow authentic, LIVE dwarf trees!
Fascinating hobby! Fabulous profit!

SEND FOR FREE SEED & INSTRUCTIONS!

MINIATURE NURSERY CLUB
Dept. J-10, Box 8794,
Los Angeles 8, Calif.

OWN your OWN

Radiator Repair Business

\$995.00 Starts You... Equips You

Many cities offer exclusive opportunity for business minded men in fast growing auto radiator repair service. New Modern Equipment brings in good profits and makes work easy and interesting. For \$995.00 (financing available) you can own a rewarding business.

You will be trained by the world's largest radiator equipment manufacturer free in their own plant, or if you want training alone the cost is \$100.00. Specify interest in training alone.

Inland Mfg. Co. Dept. PM-10 1108 Jackson St.
Omaha 8, Nebraska

POPULAR MECHANICS

Copyrighted material



"Opened Door to Popularity"

"I was able to play many pieces in a short time. Family and friends certainly surprised. Course opened door to popularity, wider circle of friends. Recently I entered amateur contest—won First Prize."—Peter H. Kozyna, Manitoba, Canada.



Plays Banjo in a Short Time

"Enjoy your lessons for the Tenor Banjo; am progressing rapidly. Lessons are so simple, anyone can understand; yet so thorough I have learned to play by note in little more than 2 months!"—Andrew Schneider, Hanna, Wyoming.



Course Inspires Music Circle

Shown above is Miss Mildred Cade, of Houston, Texas. She and a number of her friends are so enthusiastic about the U. S. School of Music's quick easy way of learning that they've ALL taken it up.



"Can't Thank Your School Enough"

"Never studied music before. Your method is easy; better your own teacher is best. After 4 lessons, I could play a few pieces. Now play any piece I like. Can't thank you enough."—Rose Boyer, Blackwell, Mo.

THOUSANDS NOW PLAY

who never thought they could!

**THIS FAMOUS WAY MAKES IT EASY AS A-B-C TO LEARN
— EVEN IF YOU DON'T KNOW A SINGLE NOTE NOW**

YOU think it's difficult to learn music? That's what thousands of others have thought! Just like you, they long to play some instrument—the piano, accordion, violin, guitar, saxophone or some other favorite. But they denied themselves the pleasure—because they thought it took months and years of tedious study to learn!

Learn in Spare Time at Home

And then they made an amazing discovery! They learned about a wonderful way to learn music at home—without a private teacher—without tedious study—and in a surprisingly short time. They wrote to the U. S. School of Music for the facts about this remarkable short-cut method. And the facts opened their eyes! They were amazed to find how easy it was to learn!

900,000 Students!

The result? Over 900,000 men and women have taken up music at home this simple A-B-C way. Now, all over the world, enthusiastic music-lovers are enjoying the thrilling satisfac-

Becomes Famous Band Leader



The Champagne Music of LAWRENCE WELK'S orchestra is enjoyed by millions. He writes: "I got my start with a U. S. School Course. How easy it is to learn to read notes and play an instrument this 'teach-yourself' way! You did so much for me that I've enrolled my two daughters."

tion of creating their own music. They have found the key to good times, and popularity.

Costs Only Few Cents a Lesson

And that's what you can do, right now. **NO TEDIOUS PRACTICING OF BORING SCALES AND EXERCISES!** Even if you don't know a single note now, you'll "start right in on pieces." This builds up your skill and confidence so rapidly that soon you'll be able to play **ALL** your favorite songs and compositions by note. It's all so clearly explained — so **EASY** to understand — that even children "catch on" at once.

Why not let this famous home study method bring the many pleasures of music into **YOUR** life! New friends. Extra money from playing or teaching. Greater listening pleasure. Possibly a brilliant career. Best of all, the deep **personal** satisfaction of being able to make your own music—provide your own entertainment.

FREE BOOK

Let us **PROVE** that what we say is true. See for yourself why our School has been so successful for 56 years. Mail the coupon and we'll gladly send you our valuable 36-page **FREE BOOK** showing how easily you can learn music this modern way. No obligation; no salesman will call on you. **U. S. SCHOOL OF MUSIC, Studio 3010, Port Washington, N. Y.** (Special Reduced prices on instruments to our students.)



CHOOSE YOUR FAVORITE INSTRUMENT

Now it's easy to learn — by note — Piano, Guitar, Piano Accordion, Violin, Hawaiian Guitar, Mandolin, Trumpet, Cornet, Saxophone, Tenor Banjo, Organ, Ukulele, Clarinet, Trombone, Flute, Piccolo, Modern Elementary Harmony. Write your choice in coupon.

Mail this for FREE BOOK

U. S. SCHOOL OF MUSIC, Studio 3010 Port Washington, N. Y.

Please send me your 36-page illustrated **FREE Book**. No salesman will call upon me. I'm interested in playing (name instrument).

I do I do NOT—have instrument now.

Name _____ (Please Print)

Address _____

City _____ Zone _____ State _____

Learn **ELECTRIC** APPLIANCE REPAIR IN YOUR *Spare Time at Home*



START YOUR OWN BUSINESS

WITH A POTENTIAL MARKET OF 50,000,000 CUSTOMERS
New shop-method, home training system gives you electrical know-how that used to take years to learn. Learn at home by building valuable testing kits, repairing your own and neighbor's appliances. It is not unusual for appliance repairmen to charge on the basis of \$5.00-\$8.00 an hour.

FREE ILLUSTRATED BOOK Shows you how you learn every phase of electrical appliance. How to make money while you learn. Write today for your FREE copy.

CHRISTY TRADES SCHOOL, INC., Dept. D-3503
4804 North Kedzie Ave. Chicago 25

SEND FOR Free Record START SPEAKING SPANISH OR FRENCH



ALMOST OVERNIGHT!



MORE MONEY



NEW CAREER



TRAVEL FUN

HERE'S the easiest way to learn a new language. Listen to **FREE** 2-sided non-breakable record. Let your eyes follow words in **FREE** sample lesson. Almost at once you'll be chatting whole sentences in your new language with a *perfect accent!* There are no "strings" to offer. But it may end soon. Rush name, address with 25c to help cover cost of special packaging, shipping of free record, lesson. State language you want. We'll also send free information on full Cortina course. No obligation.

CORTINA ACADEMY

"Originators of the Phonograph Method"

Dept. 6410, 136 W. 52nd St., New York 19, N. Y.

Also:
GERMAN
ITALIAN
RUSSIAN
JAPANESE
BRAZILIAN

INVENTORS

PROTECT YOUR INVENTION BY A U. S. PATENT. SEND FOR FREE "INVENTION RECORD" FORM AND "PATENT INFORMATION EVERY INVENTOR SHOULD HAVE."

CARL MILLER

REGISTERED PATENT ATTORNEY

WOOLWORTH BLDG., 35th FLOOR, 104A
NEW YORK CITY



PATENTS

C. A. SNOW & CO.

REGISTERED PATENT ATTORNEYS
WRITE FOR INFORMATION TO
428 SNOW BUILDING, WASHINGTON 1, D. C.

INVENTORS

Send for
PATENT INFORMATION
Book and
INVENTOR'S RECORD
without obligation

GUSTAVE MILLER
104-PM WARNER BUILDING
WASHINGTON 4, D. C.

REGISTERED PATENT ATTORNEY
ASSOCIATE EXAMINER
U. S. PAT. OFF. 1922-1929

Patent Attorney & Advisor
U. S. NAVY DEPT. 1930-1947
PATENT LAWYER

FREE AMAZING NEW BOOK "HOW TO ANSWER ADS"



Never before have you seen anything like this. Tells you in simple language the correct way to answer ads. Gets you quicker replies—better results, and greater satisfaction. Will save you time and money and it's **ABSOLUTELY FREE**. No obligation whatever. Every reader of advertising should have this booklet. Send a postcard for your copy **NOW**. Advertising Department, Popular Mechanics Magazine, Room 602-A, 204 East Ontario Street, Chicago 11, Ill.

INVENTIONS WANTED

If you want to market, or sell, your invention for cash or royalties, Write for our **Free Booklet**. Send no drawings. We also welcome hearing from firms, or private capital, wishing to review inventions in any field. We will be glad to send notice of our clients' inventions.

GLOBAL MARKETING SERVICE

1404 Mitchell Street Dept. PD Oakland 1, Calif.

INVENTORS

Whether an invention is patentable can be substantially determined by a search of the U. S. Patent records. Without obligation, write for information explaining the steps you should take to secure a patent.

JOHN N. RANDOLPH

Registered Patent Attorney

201 Columbian Building, Washington 1, D. C.

INVENTORS

I shall be pleased to furnish you, upon request, with full information relative to patent procedure—without any obligation on your part.

PATRICK D. BEAVERS

Registered Patent Attorney

934 Columbian Building Washington 1, D. C.

THERE'S A "SECRET" TO EASY AUTO REPAIRS ... and this giant book is it!



FIX CARS

THIS EASIER
FA-STER
WAY!

Handle practically ANY job on ANY make, model or part since 1940



**New, Enlarged
1954 Edition!**

- Weights 4 3/4 pounds!**
- Has 864 big pages**
... each one almost TWICE as big as this magazine page!
- Covers EVERY model of the above 20 makes SINCE 1940!**
- 58 Troubleshooting Charts—353 "Quick Checks" Data Tables**
- 2532 clear, how-to-do-it pictures**
- ... and thousands upon thousands of helpful parts and service specifications.

Using this giant Chilton "ALL CARS" auto repair manual is like having 19 of the world's greatest service experts standing by your side.

First they tell you how to locate the trouble. Then they show you how to fix it "slick as a whistle."

Step by step they guide you ... even to telling you what tools to use. No guesswork! No wasted time!

And you don't need a lot of previous experience to do EVERY job fast and right!

Complete, Easy-To-Understand Car Repair Instructions

Just look up the make, model and part of the car you want to fix. Simple, easy instructions PLUS big, clear pictures show you exactly what to do, what shortcuts to take, what changes or adjustments to make,

what parts to replace, what mistakes to watch out for.

From simple tune-ups to carburetor troubles ... from rear end jobs to engine overhauls ... from windshield wipers to ignition systems ... or from clutches, axles, oil pumps, cooling systems and king pins to standard and automatic transmissions, overdrives, power brakes and steering and dozens more, this big book makes each job as clear as A-B-C.

Remember! For over 25 years, previous editions of this famous Chilton "ALL CARS" Manual have been first choice of beginners, garages, schools and for Army-Navy car repair training ... because it has long been recognized as the largest, most complete, fully authentic manual of its kind ... and, because it makes the work so clear that even beginners cannot fail to understand every step.

**Covers 14 Years
of Cars!**

PRACTICE 10 DAYS FREE!

The Chilton Co., Dept. PM-104
56th & Chestnut Sts., Philadelphia 39, Pa.

Send the big 864-page Chilton "ALL CARS" REPAIR MANUAL (Price \$6.95) for 10-day FREE EXAMINATION. If I like it, I will then promptly remit \$1.95 (plus 35c postage); then send \$2.50 monthly for 2 months. Otherwise, I will return manual postpaid in 10 days and owe you nothing.

(OUTSIDE U.S.A.—Cash only, price \$7.95. Same 10 day return privilege with money refunded.)

Name

Address

City, Zone, State

**By the world's largest
automotive publishers!**

Get the big, complete CHILTON service manual that comes direct from automotive publishing headquarters ... home of AUTOMOTIVE INDUSTRIES, COMMERCIAL CAR JOURNAL and MOTOR AGE magazines, the well-known Chilton FLAT RATE book, etc.!

WE CAN TEACH YOU TO MOUNT BIRDS

GEE, BILL, THIS SQUIRREL ACTUALLY LOOKS ALIVE. ALL THE FELLOWS THINK YOUR DEN IS GREAT.

IT'S EASY, FRED, ONCE YOU GET THE HANG OF IT. I LEARNED BY MAIL IN MY SPARE TIME.

TAXIDERMISTRY IS THE GRANDEST HOBBY IN THE WORLD—AND PROFITABLE, TOO. IN FACT, THIS

OWL BOOK-END IS FOR A CUSTOMER. FRED, WHY DON'T YOU WRITE TO THE NORTHWESTERN SCHOOL FOR THEIR FREE BOOK?

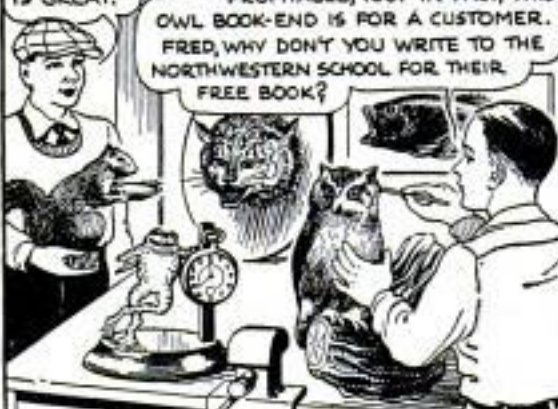

FUN - FASCINATION - PROFIT

Be a Taxidermist. New Profitable business. Learn quickly at home. MOUNT life-like Birds, Animals, Game-Heads, Fish. Have your valuable trophies. Decorate your home and den. Learn genuine Chrome Tanning for harness and sole leather, buckskin and fine furs. Mount Common specimens, squirrels, rabbits, owls, even frogs, into marvelous craft-work groups, both useful and humorous. Wild-game not necessary. Send Today for Free Book!

BIG PROFITS Turn your spare time to cash. Have a side-line profitable business. Mount game trophies for apartments; sell your own mounts; save money and Make Money with expert tanning. Learn by mail from old reliable school, with 400,000 graduates. Investigate Today.

FREE BOOK 48 pages, very interesting. 100 beautiful GAME PICTURES. Tells how YOU can become a taxidermist. Absolutely FREE if you send at once. Write for YOUR copy TODAY—THIS MINUTE. State your AGE.

N. W. School of Taxidermy, 2510 Elwood Bldg., Omaha, Neb.

NEW! SUPER POWERFUL

All Channel VHF-UHF TV RECEPTION IN ALL DIRECTIONS

ONLY **23.50**
Model AX-524

Rocket Directronic Motorless TV Antenna 360° Electronically Switched Beam



In the fringe or ultra-fringe, the NEW 1954 Motorless Directronic will out-perform any ordinary antennas. This sensational new 360° UHF-VHF TV Antenna offers "around the compass" reception—WITHOUT Rotors. Provides superb ghost-free picture clarity. Model AX-524 "Service-man's Army" contains Hi-Pac Molded Insulator of Extreme tensile strength, 24 hi-tensile aluminum elements, including 6 Multi-purpose Reflector-directors, 1 set matched to rods, Universal Mast Clamps, 6-position Beam Selector Switch, 75' Low-loss UHF-VHF Tubular TRL-X Cable.

25% DEPOSIT ON C.O.D. ORDERS. ALL FEES F.O.B. CLEVELAND. YOU PAY POSTAGE.

NATIONAL ELECTRONICS OF CLEVELAND
310 Delco Bldg. Cleveland 3, Ohio

A "GOOD HAND" HELPS YOU SUCCEED! LEARN TO WRITE WELL

Handwriting quickly improves with our easy-to-understand picture lessons! Put your spare time to good use; send today for FREE BOOKLET. "How to Become a Good Penman," or check volumes wanted below at 51 each: Business Writing Artistic Writing Card Writing, Bird & Design Flourishing Engrossing Alphabets. COMPLETE SET \$4.50. Ask for price list of penman's supplies.

TAMBLYN SCHOOL OF PENMANSHIP
S.A. Ziller, Pres., 442 Ridge Bldg., Kansas City, Mo., USA

Earn BIG STEADY MONEY SELL WORK UNIFORMS!

It's easy with TOPPS great "Panoramie" line that spreads out over 3 feet wide! Swatches are king size! Style figures are big, full color—they almost pop off the page! Prospects are everywhere—garages, service stations, factories, etc. Profits are big—one man made \$200 on a single sale! Selection of sizes, fabrics (including DuPont's miracle ORLON), colors, embroidery is unlimited. Start spare time... you'll make it a career! Get the "Panoramie" line FREE. Write TODAY.

TOPPS Dept. 6110 - Rochester, Indiana

RADIO Engineering. All phases radio & electronics theory & practice; television; FM; broadcasting; servicing; aviation, marine & police radio. Prepare for high pay; 18-month course. Graduates in demand by major companies. Enter Jan., March, June, Sept. Regular campus life. Write for catalog.

VALPARAISO TECHNICAL INSTITUTE, Dept. D, Valparaiso, Ind.

Broken or Loose FALSE PLATE?

Fix it Yourself EASILY in a Few Minutes
Your plates may become broken or loose just when you need them most. With FIX-IT-KIT you can repair your own broken plates. Also tightens loose fitting plates, easily. Get permanent comfort with professional material. Complete instructions. Satisfaction guaranteed or your money refunded. Order Now at a new low price only \$2.98 postpaid—or sent C.O.D.

DENT-FIX DENTAL PRODUCTS, Box 674, Dept. PM-10, Kansas City 41, Mo.

56 Pages of Outdoor Fireplace Designs and Ideas

A COMPLETE GUIDE you or your builder can easily follow to get a perfect "fun center" for your family and guests. Includes "outdoor" recipes and menus, clever cook-nook accessories. Illustrates all-metal fireplace units that simplify correct construction with any masonry. Send only 25c for your copy. The Majestic Co., Inc., 436 Erie St., Huntington, Indiana.

Only 25c Postpaid
New Beauty for Your Lawn



Capra Gems

more dazzling than diamonds



Free Booklet Shows How You Can Own A CAPRA GEM For 1/30 The Cost Of A Diamond!

Get full facts, FREE, on the most amazing discovery by modern science—CAPRA GEMS. A miracle of science described in recent issues of *Saturday Evening Post* and *Reader's Digest*. They're more dazzling than diamonds, yet cost much less. CAPRA GEMS' refractive quality is actually higher than diamonds! Brilliantly beautiful, dazzling CAPRA GEMS are hand cut, hand polished and hand selected... priced within the reach of all who love fine gems. A 1-carat diamond stone costs you approximately \$1000. A comparable choice selected, 1-carat CAPRA GEM is yours for \$24, federal tax included... and can be bought in small easy payments.

GET THE FACTS NOW

Valuable illustrated booklet shows a wide selection of men's and women's rings. Gives full details, including prices and settings... shows all CAPRA GEMS actual size. Limited supply, so send today without delay. No charge, no obligation. Get all the facts on CAPRA GEMS... more dazzling than diamonds.

—SEND NO MONEY—

CAPRA GEMS CO., Dept. PM-10 P.O. 5145, Phila. 41

Name

Address

City..... Zone..... State.....

New PROFIT-PROVEN* Home-Business!

"I make \$400⁰⁰
a week!"



SCREEN PRINT CO., P.O. Box 61007 So. Sta.
Dept. 2-A
15130 S. Broadway, Los Angeles 61, Calif.
Gentlemen: Please mail me Free Revealing
Details, samples, Opportunity Plan,
etc.—All this is sent absolutely Free and
sent to me by return mail. I am under no
obligation now or ever.

NAME _____
ADDRESS _____
CITY _____ ZONE _____ STATE _____



free!

Complete REVEALING DETAILS,
Authentic SAMPLES, Proven
Big-Money OPPORTUNITY
PLAN, "HOW-TO" BOOKLET.
Learn the secrets. Rush
this coupon TODAY!

*Proves MR. J. T. ANDERSON, Inglewood, Calif.
(Notarized statement on file in our
office and open to inspection)

Big Money?—sure it is—because Huge Profits
are waiting to be "tapped" with this **MIRACLE
NEW PRINTING METHOD**. Now, you may share
the exciting secrets and build a big-paying **FULL
OR SPARE TIME** Screen Printing Business right
IN YOUR OWN HOME. Yes, we'll teach you,
too, how to turn pennies into dollars in this
newest, most sensational printing method ever
invented. **WHAT IS SCREEN-PRINT?** It's an ex-
citing new printing technique—amazingly sim-
ple and fascinating. (It may soon revolutionize
the entire printing industry) **NO EXPENSIVE
EQUIPMENT**, no printing press, no "cuts," no art
ability, no experience is necessary—yet you can
print beautiful professional jobs on **PAPER,
GLASS, LEATHER, CLOTH—ANYTHING!** You print
in all colors—even new "glowing" **FLOUORESCENT**

COLORS. It's amazing—but true! **EARN PROFITS
IMMEDIATELY—IN YOUR OWN HOME!** Start
in your garage, basement, kitchen, spare room
—anywhere! It's much easier than you think.
Then expand as this new printing industry
grows. **300% PROFIT** on some jobs—earn up to
\$12.50 per hr. **HELP FILL THE HUGE GROWING
DEMAND**. No selling because every business in
your area needs Screen-Printing. You can save
them up to 50% on printing, too. **WE SUPPLY
EVERYTHING YOU NEED**. Never before has such
a profitunity been offered to anyone wishing to
start a full-time or spare-time "business of his
own." Don't Hesitate! All the **CONFIDENTIAL
FACTS** are yours if you **MAIL COUPON TODAY**—
before it's too late.

**READ WHAT OTHERS
ARE SAYING**—Investigate!
"Would not
take \$1000.00 for
secret...just what I
have been searching
the world over for,"
C.S., Nev.; "Making
75% of living ex-
penses already in
spare time," E.L.,
Ontario; "Made \$80
first week—terrific
opportunity"—
W.S., Iowa.

Mail Coupon and
Learn Secrets Too!

Print colorful ADVERTISING DISPLAYS, SIGNS, BANNERS, POSTERS, LABELS, WALLPAPER, NOVELTIES, INSTRUMENTS, ETC. ET

GIANT BALLOONS

Surplus U. S. Gov't. (new-overage)
NEOPRENE weather, target balloons. For
FUN or PROFIT. Great sport in the back-
yard; or for parties, picnics, dances,
fairs. **MONEY-MAKERS**. Use these bal-
loons to attract crowds to civic events,
conventions, exhibitions, trade shows.
TERRIFIC for high school and college
PROMS. All sizes are approx. inflated
size. We pay postage on prepaid orders.

3 ft. dia. 49c — 6 ft. dia. 99c
13 ft. dia. \$1.59 — 20 ft. dia. \$1.95

* Calif. residents please add sales tax.

WAR ASSETS DIV. VOLUME SALES CO.
Dept. M-1054 3930 Sunset Blvd. Los Angeles 29, Calif.

AUTO BODY MEN
Expd. comb. paint and metal work.
good, high earnings; tidy, dr. Norman
Moore, 1612 Chicago, Evanston,
ILLINOIS 4-4100.

AUTO body and fender man
Wanted. Also good in
body work. 65 E.
MAY ST. CHICAGO
TOOK READY FOR
2300 S. MICHIGAN

AUTO body fender man in 50-
over. H. J. Moore,
7 W. L. ST. CHICAGO
5353

AUTO body fender man
Wanted. Also good in
body work. 65 E.
MAY ST. CHICAGO
TOOK READY FOR
2300 S. MICHIGAN

AUTO BODY-FENDER MAN
Ideal working conditions: tidy, dr.
Norman Moore, 1612 Chicago, Evanston,
ILLINOIS 4-4100.

Auto Body Craftsmen
WANTED!
Auto Body Fender Man
Wanted. Also good in
body work. 65 E.
MAY ST. CHICAGO
TOOK READY FOR
2300 S. MICHIGAN

AUTO BODY MEN
To work on cars and trucks.
Lincoln 9-5833.

'How to MAKE MONEY with Simple CARTOONS'



A book everyone who likes to draw
should have. It is free; no
obligation. Simply address **FREE
BOOK**

CARTOONISTS' EXCHANGE
Dept. 910D Pleasant Hill, Ohio

Free Book on Arthritis And Rheumatism

HOW TO AVOID CRIPPLING DEFORMITIES

An amazing newly enlarged 44-page book entitled
"Rheumatism" will be sent free to anyone who will
write for it.

It reveals why drugs and medicines give only tem-
porary relief and fail to remove the causes of the
trouble; explains a proven specialized non-surgical,
non-medical treatment which has proven successful for
the past 35 years.

You incur no obligation in sending for this instructive
book. It may be the means of saving you years of untold
misery. Write today to The Ball Clinic, Dept. 756,
Excelsior Springs, Missouri.

Learn This Craft—Earn Big Money

Look at the Help Wanted ads in your paper. The billion-dollar auto repair
trade needs trained men NOW! The demand is big... pay is big... oppor-
tunities are great. You have a chance to grow with this growing trade, per-
haps set up your own profitable shop.

CASH IN ON YOUR SPARE TIME!

You can begin your Auto Body-& Fender Training at home in spare time
with the proven UEI plan. You learn about appearance reconditioning,
metalwork, painting, welding, other practical phases without leaving your
present job. Then get actual practice in our large, well-equipped shops, re-
pairing wrecked cars under the guidance of skilled instructors. Get FREE
book and all the facts by sending coupon NOW!

UTILITIES ENGINEERING INSTITUTE 2523 Sheffield Ave., Dept. XC-31
Auto-Crafts Div. Chicago 14, Ill.

MAIL TODAY FOR FREE FACTS

UEI
has been
training
men for
industry
since
1927.

Auto-Crafts Div.
UTILITIES ENGINEERING INSTITUTE
2523 Sheffield Ave., Dept. XC-31, Chicago 14, Ill.
YES! Rush FREE Book and full facts on Auto Body & Fender Re-
pair Training.

Name _____ Age _____
Address _____
City _____ Zone or County _____ State _____
() Check for special information if under 17.

**PROFESSIONAL-TYPE ELECTRIC
HAIR CLIPPER**



ONLY
\$10⁹⁵

At Your Barber,
Beauty Shop or
Dealer's

**Cadet[®]
ELECTRIC HAIR CLIPPER**

Saves time and money for the whole family! Has cool-running magnetic motor; fine-tooth blade for close cutting; streamlined plastic case. 110v 60 cycle AC; fully tested by UL. If your barber, beauty shop or dealer cannot supply you, order direct on 10-day money-back guarantee.

**ELECTRO TOOL CORPORATION
DEPT. C524-K • RACINE, WISCONSIN**

**105 POWER
SUPER TELESCOPE**



Everything for the Astronomer, Hobbyist, Student, and Scout in this complete astronomical super value telescope combination. Set comes ready for immediate use, consists of brilliant 33x-65x-105x telescope, 5 foot hardwood Tripod, carrying case for scope, Star Explorer map and 108 page book "Discover the Stars." The 3 foot telescope (closes to 16 inches) is brass bound, has 4 precision lenses that will bring distant objects, people, moon, stars, ships, etc., 105 times closer. All images erect. The sturdily built tripod is equipped with universal mount that has a 360 degree horizontal range and 180 degree vertical range. It locks in any position with one simple adjustment. The Star Explorer map enables you to find any star automatically. This marvelous all purpose instrument is proclaimed by Scientists as a most unusual development. Everyone that has used it is amazed at its performance and value. It will fascinate the entire family. Shipped to you complete, nothing else to buy, at the amazing low price of.....

\$11⁹⁵
POST
PAID

Satisfaction guaranteed or money refunded. We pay all delivery charges. Send check or money order to DEPT. PMS 4

CRITERION CO. 331 CHURCH ST., HARTFORD I, CONN.

**OWN
Your Own
Business**

\$5 per hour

Clean and Mathproof rugs and upholstery "in the home", office, institution. If now employed, you can operate in spare time and build a permanent full-time business.

Alert dealers can gross \$5 hourly profit on service they render plus \$3 on EACH serviceman. We locally train and assist you. Easy to learn quickly established.



DURACLEAN cleans by absorption! No scrubbing, soaking or shrinkage. Dirt and grease vanish... matted pile rises... colors revive. Furnishings used again same day.

DURAPROOF resists moths and carpet beetles. Your service backed by an International Money Back 6 Year Warranty.

We furnish enough material to return your total investment. Send TODAY for FREE booklet explaining details and EASY TERMS.

DURACLEAN CO., 4-160 DURACLEAN BLDG. DEERFIELD, ILL.

FREE! SEND FOR MY NEW PLAN FOR A BUSINESS OF YOUR OWN!

METALIZE BABY SHOES
Add to your present income or have a full-time business. Fill huge demand for most precious keepsakes. Start at once—no big investment. Complete instructions include all processing methods. It's fun and very profitable. Start now — SEND NO MONEY — just name and address.
KIKTAVI CO., Dept. PM-5418, 7217 S. Broadway, Los Angeles 3, Cal.

*Instructions Include Complete Kit of Supplies & Beautiful BRONZED BABY SHOE

RUPTURED

BE FREE FROM TRUSS SLAVERY

NOW there is a new modern Non-Surgical treatment that permanently corrects rupture. These Non-Surgical treatments are so certain, that a Lifetime Certificate of Assurance is given. Write today for our New FREE Book that gives facts that may save you painful and expensive surgery, and tells how non-surgically you may again work, live, play and love and enjoy life in the manner you desire. There is no obligation. **Excelsior Hernia Clinic Dept. 8305 Excelsior Springs, Mo.**

LEARN LOCKSMITHING
Learn this fascinating, profitable trade from experts in your spare time at home! Age or physical handicap no disadvantage. Year around, steady income. Full or part time. Practical, illustrated lessons. You can make money even while learning! All materials and special tools supplied without extra charge.
INSTITUTE OF LOCKSMITHING, Dept. P-59 15 PARK AVENUE RUTHERFORD, N. J. Lic. by N.J. State Board of Education Approved for Veterans

Make BIG MONEY!
RAISE CHINCHILLA RABBITS!
Cash Markets Supplied for Year Production
FREE - Illustrated Booklet - WRITE TODAY!
ROCK HILL RANCH, SELLERSVILLE 36, PA.
World's Largest Breeder of Chinchilla Rabbits

Catalog of 3000 Novelties 10c

Send 10c for amazing catalog of novelties, live animals, scientific supplies, hobbies, funmakers, planes & boats, looms, magic tricks, joke articles, unusual seeds, gadget time-savers, cameras, optical goods, projectors, movies, lucky jewelry, religious novelties, disguises, musical instruments, stamps, coins, puzzles, fortune tellers, radios, auto & bike accessories, telescopes, magnifiers, compasses, banks, smokers' gadgets, artists' supplies, printing sets, engines, motors, shockers, knives, billfolds, guns, rifles, sports, books, games, plants, etc. Send 10c (3 for 25c—get for friends!).

JOHNSON SMITH & CO., Dept. 829, Detroit 7, Michigan

Learn PHOTOGRAPHY at Home

Splendid opportunities. Prepare in spare time. Practical basic training. Long-established school. Send for free book, "Opportunities in Photography." No obligation.
AMERICAN SCHOOL OF PHOTOGRAPHY, 835 Diversey Pkwy., Dept. 1357, Chicago 14, Ill.

POPULAR MECHANICS

CAN YOU PROFIT BY THEIR MISTAKES?



"I didn't get enough education"

You needn't make that mistake. You can get that better job, those big promotions, the regular raises that so many I.C.S. students report. And you can do it without "going to school," without interfering with your present job or your social life.

YOU can study with I. C. S. at home, in your spare time!



"I chose the wrong career"

When you study with I. C. S. you have 277 courses to choose from. And part of our job here at I. C. S. is not only giving you sound, practical, up-to-date instruction, but making sure you pick the course that's right for you!

YOU get expert guidance FREE when you mail the I. C. S. coupon!



"I failed to seize opportunities"

Your opportunity—the turning point in your life—may be right here on this page. Don't pass it by. Don't put off mailing the coupon. Send it now and let us return to you the free book, "How to Succeed," opportunity catalog and free lesson.

YOU can start cashing in on opportunities by acting now!



3 FREE BOOKS 36-page, pocket-size guide to advancement, a gold mine of tips on "How to Succeed." Also big catalog outlining opportunities in your field of interest. And free sample I. C. S. lesson text.

For Real Job Security—Get an I. C. S. Diploma!

I. C. S., Scranton 9, Penna.

INTERNATIONAL CORRESPONDENCE SCHOOLS

ICS

BOX 5634-L, SCRANTON 9, PENNA.

(Partial list of 277 courses)

Without cost or obligation, send me "HOW TO SUCCEED" and the opportunity booklet about the field BEFORE which I have marked X (plus sample lesson):

- | | | | | |
|---|---|---|---|---|
| <input type="checkbox"/> ARCHITECTURE and BUILDING CONSTRUCTION | <input type="checkbox"/> AVIATION | <input type="checkbox"/> CIVIL, STRUCTURAL ENGINEERING | <input type="checkbox"/> LEADERSHIP | <input type="checkbox"/> RAILROAD |
| <input type="checkbox"/> Air Conditioning—Refrig. | <input type="checkbox"/> Aeronautical Engineering Jr. | <input type="checkbox"/> Civil Engineering | <input type="checkbox"/> Foremanship | <input type="checkbox"/> Air Brakes <input type="checkbox"/> Car Inspector |
| <input type="checkbox"/> Architecture | <input type="checkbox"/> Aircraft & Engine Mechanic | <input type="checkbox"/> Construction Engineering | <input type="checkbox"/> Industrial Supervision | <input type="checkbox"/> Diesel Locomotive |
| <input type="checkbox"/> Building Contractor | BUSINESS | <input type="checkbox"/> Highway Engineering | <input type="checkbox"/> Leadership and Organization | <input type="checkbox"/> Locomotive Engineer |
| <input type="checkbox"/> Building Maintenance | <input type="checkbox"/> Advertising | <input type="checkbox"/> Reading Struct. Blueprints | <input type="checkbox"/> Personnel-Labor Relations | <input type="checkbox"/> Section Foreman |
| <input type="checkbox"/> Carpenter and Mill Work | <input type="checkbox"/> Bookkeeping and Accounting | <input type="checkbox"/> Sanitary Engineering | MECHANICAL AND SHOP | STEAM AND DIESEL POWER |
| <input type="checkbox"/> Estimating | <input type="checkbox"/> Business Administration | <input type="checkbox"/> Structural Engineering | <input type="checkbox"/> Gas—Electric Welding | <input type="checkbox"/> Combustion Engineering |
| <input type="checkbox"/> Heating | <input type="checkbox"/> Business Correspondence | <input type="checkbox"/> Surveying and Mapping | <input type="checkbox"/> Heat Treatment <input type="checkbox"/> Metallurgy | <input type="checkbox"/> Diesel—Elec. <input type="checkbox"/> Diesel Eng's |
| <input type="checkbox"/> Painting Contractor | <input type="checkbox"/> Certified Public Accounting | DRAFTING | <input type="checkbox"/> Industrial Engineering | <input type="checkbox"/> Electric Light and Power |
| <input type="checkbox"/> Plumbing | <input type="checkbox"/> Creative Salesmanship | <input type="checkbox"/> Aircraft Drafting | <input type="checkbox"/> Industrial Instrumentation | <input type="checkbox"/> Stationary Fireman |
| <input type="checkbox"/> Reading Arch. Blueprints | <input type="checkbox"/> Federal Tax | <input type="checkbox"/> Architectural Drafting | <input type="checkbox"/> Industrial Supervision | <input type="checkbox"/> Stationary Steam Engineering |
| <input type="checkbox"/> Steamfitting | <input type="checkbox"/> Letter-writing Improvement | <input type="checkbox"/> Electrical Drafting | <input type="checkbox"/> Machine Design—Drafting | TEXTILE |
| ART | <input type="checkbox"/> Managing Small Business | <input type="checkbox"/> Mechanical Drafting | <input type="checkbox"/> Machine Shop Inspection | <input type="checkbox"/> Carding and Spinning |
| <input type="checkbox"/> Cartooning | <input type="checkbox"/> Office Management | <input type="checkbox"/> Mine Surveying and Mapping | <input type="checkbox"/> Machine Shop Practice | <input type="checkbox"/> Cotton, Rayon, Woolen Mfg. |
| <input type="checkbox"/> Commercial Art | <input type="checkbox"/> Retail Business Management | <input type="checkbox"/> Ship Drafting | <input type="checkbox"/> Mechanical Engineering | <input type="checkbox"/> Finishing and Dyeing |
| <input type="checkbox"/> Fashion Illustrating | <input type="checkbox"/> Sales Management | <input type="checkbox"/> Structural Drafting | <input type="checkbox"/> Quality Control | <input type="checkbox"/> Loom Fixing |
| <input type="checkbox"/> Magazine Illustrating | <input type="checkbox"/> Stenographic-Secretarial | ELECTRICAL | <input type="checkbox"/> Reading Shop Blueprints | <input type="checkbox"/> Textile Designing |
| <input type="checkbox"/> Show Card and Sign Lettering | CHEMISTRY | <input type="checkbox"/> Electrical Engineering | <input type="checkbox"/> Refrigeration | <input type="checkbox"/> Textile Eng'g's <input type="checkbox"/> Throwing |
| <input type="checkbox"/> Sketching and Painting | <input type="checkbox"/> Analytical Chemistry | <input type="checkbox"/> Electrical Maintenance | <input type="checkbox"/> Sheet Metal Worker | <input type="checkbox"/> Warping and Weaving |
| AUTOMOTIVE | <input type="checkbox"/> Chemical Engineering | <input type="checkbox"/> Electrician <input type="checkbox"/> Contracting | <input type="checkbox"/> Tool Design <input type="checkbox"/> Toolmaking | MISCELLANEOUS |
| <input type="checkbox"/> Auto Body Rebuilding | <input type="checkbox"/> Chem. Lab. Technician | <input type="checkbox"/> Lineman | RADIO, TELEVISION | <input type="checkbox"/> Domestic Refrigeration |
| <input type="checkbox"/> Auto Elec. Technician | <input type="checkbox"/> General Chemistry | HIGH SCHOOL | <input type="checkbox"/> Electronics | <input type="checkbox"/> Marine Engineering |
| <input type="checkbox"/> Auto-Engine Tune Up | <input type="checkbox"/> Natural Gas Prod. & Trans. | <input type="checkbox"/> Commercial | <input type="checkbox"/> Practical Radio—TV Eng'ng | <input type="checkbox"/> Ocean Navigation |
| <input type="checkbox"/> Automobile Mechanic | <input type="checkbox"/> Petroleum Engineering | <input type="checkbox"/> Good English | <input type="checkbox"/> Radio and TV Servicing | <input type="checkbox"/> Shipfitting |
| | <input type="checkbox"/> Plastics | <input type="checkbox"/> High School Subjects | <input type="checkbox"/> Radio Operating | <input type="checkbox"/> Short Story Writing |
| | <input type="checkbox"/> Pulp and Paper Making | <input type="checkbox"/> Mathematics | <input type="checkbox"/> Television—Technician | <input type="checkbox"/> Telephony |

Name _____ Age _____ Home Address _____

City _____ Zone _____ State _____ Working Hours _____ A.M. to P.M. _____

Occupation _____

Canadian residents send coupon to International Correspondence Schools, Canadian, Ltd., Montreal, Canada. . . . Special tuition rates to members of the U. S. Armed Forces.

Over \$450⁰⁰ Profit!

I SOLD 67
D-FROST-O-MATICS
IN JUST 5 DAYS
SPARE TIME!



BILL CARNEY

Get the EXTRA MONEY
YOU Want This Easy Way!

Amazing D-FROST-O-MATIC Makes Any
Electric Refrigerator Self-Defrosting!

Bill Carney is just one of thousands of alert men, all over America, who have found money-making "magic" in the words "Never defrost your refrigerator" and showing housewives how amazing D-FROST-O-MATIC ends messy, time-wasting hand defrosting forever. Bill Carney's record is exceptional—but our sure-fire FREE TRIAL PLAN can pay YOU up to \$210.00 a week on just five easy sales a day! Today every housewife wants automatic defrosting. So you just plug in D-FROST-O-MATIC, tell the housewife "Try it before you buy it" and when she sees how D-FROST-O-MATIC saves time, work, food, and money, and you tell its amazing low cost—she won't let you take it out! Many D-FROST-O-MATIC men sell 5, 7, 10 and more units in A DAY on this "sells-itself" FREE TRIAL PLAN!

"Anyone Can Sell Them"

"All you do is place them in the homes, D-FROST-O-MATIC itself does the rest. My profit has been several times over what I hoped for."
Bill Carney, Mo.

Rush Name Today for Profit
Details and FREE TRIAL PLAN!

More than 29,000,000 prospects waiting! Rush your name and address today. We'll airmail exciting facts, proof and sure-profit Free Trial plan. No obligation. Write today.

D-FROST-O-MATIC, Dept. A-6
173 W. Madison Street, Chicago 2, Ill.

BUILD HELICOPTER GLIDER



The famous GYRO-GLIDER, engine-less helicopter, world's smallest flying machine.

BUILD AND FLY IT YOURSELF.

- Three-View Drawings & Specs—only \$1.00
- Detailed Construction Plans with Building and Flying Instructions—\$98.00
- Raw Materials Kits—\$98.00
- Machined parts and Kits also available. Order yours TODAY.

10-DAY MONEY-BACK GUARANTEE
RENSEN AIRCRAFT CORP. Dept. PM9
P. O. Box 2621 Raleigh, N. C.

I GAINED
53 LBS. OF SHAPELY
MUSCLES

says Roger Hirsch, N. Y.

NOW
Which of these
2 ME'S is YOU?
BEFORE

"That 112 lb.—6 ft. spindly-armed Sissy at right was ME a few short weeks ago", says Roger Hirsch. Look at him NOW! I gave him 53 lbs. of NIGHTY MUSCLES, added 6 1/2 inches to his CHEST, 3 inches to each ARM! They don't call him SKINNY any more!

NO! I don't care how skinny or flabby you are. All I want is 10 minutes a day in your home to make you over by the same method I turned myself from a wreck into a Champion of Champions. You'll become an ALL-ROUND, ALL-AMERICAN, HE-MAN, A WINNER in everything you tackle—or my training won't cost you one cent.

ROGER HIRSCH
was a
112 lb., 6 ft.
WEAKLING.
Look at
him NOW!

SEND ME ONLY 10¢ for 5 PICTURE-PACKED HE-MAN BUILDING Courses and also get

Both FREE 1. PHOTO BOOK OF STRONG MEN
2. A MUSCLE METER

JOWEY INSTITUTE, Dept.
220 Fifth Ave., New York 1, N.Y. PM-410

Dear George: I enclose 10¢ for which please send me no trial kit! I picture-packed HE-MAN Building Course, FREE Photo Book, and Muscle Meter.

NAME..... AGE.....
(Please print plainly. Include Zone Number)

ADDRESS..... No C.O.D.'s

CITY..... Zone..... State.....

"Win This
15" Silver
Trophy
as I
did."



MAKE EXTRA
MONEY

PLASTICS

LEARN
AT HOME

LEARN HOW
TO MAKE
fast-selling
PLASTIC
NOVELTIES
FURNITURE
JEWELRY



There are RICH OPPORTUNITIES for MEN and WOMEN with "know-how" in Plastics. Interstate's new Plastics course tells and shows how to make hundreds of fast selling items out of Plastics. Gives complete training in fabrication, casting, lamination, molding, internal carving, etc., in simple, easy, step-by-step language and pictures. Plastics and Fabricating Kits for 23 valuable Plastic items come with training at no extra cost. START A PLASTICS BUSINESS OF YOUR OWN. No other industry holds such promise for the future. You can make big money manufacturing novelties, toys, signs, etc., in your own home in spare or full time. Don't wait! Learn NOW how Interstate's Plastics Training qualifies you for success in the Plastics field.

PLASTICS AND SUPPLIES FURNISHED
FOR 23 VALUABLE PROJECTS

INTERSTATE TRAINING SERVICE
Dept. C-3-K Portland 13, Oregon

New Way to Improve YOUR
ENGLISH



A command of effective English gives you added advantages and better opportunities. Poor English handicaps you more than you will ever realize. You can improve your English through Sherwin Cody's 100% self-correcting invention. If you are embarrassed by mistakes in grammar, spelling, punctuation, or pronunciation, this free book "How You Can Master Good English in 15 Minutes a Day" will prove a revelation to you. Send for it now. It is free. No obligation. No agent will call. Address SHERWIN CODY COURSE IN ENGLISH, 5810 Central Drive, Port Washington, N. Y.

Finish HIGH SCHOOL AT HOME

Complete 4 Yrs. in 12 Months

Learn More! Earn More! Enter professional or technical schools. Advance Socially. Live a Happier, Fuller Life. Individual Courses or complete schedule. WRITE FOR SCHOOL BULLETIN.

ACADEMY FOR ADULTS
30 W. Washington, Dept. PM-1004, Chicago, Ill.

LEARN WATCH REPAIRING

AT HOME Modern, original instruction. Prepare for a position or start in business after completing our course. Write Today!
WISCONSIN SCHOOL OF WATCH REPAIRING
2908 N. 44th St. Dept. M Milwaukee 10, Wis.

New Accurate 10"
SLIDE Rule



Professional Model

\$2

For multiplying, proportions, division, extracting roots—different calculations at lightning speed without paper or pencil. Easy to learn!—ABC 32 pg. Inst. Book Free. Scaled A-B-C-D-E-F-G-H-I-J-K-L-M-N-O-P-Q-R-S-T. Lacquer Finish. Leather Case. UNIVERSAL MAIL MART, Inc., M-10R, 27 E. 22 St., N.Y., N.Y.



Brighten Your T. V.

With Gill's amazing New Picture Tube Booster. Improves any T. V. picture or your money refunded. Simple installation without tools. PRICE \$2.95 POSTPAID

\$2.95
POSTPAID

GILL'S T.V.
8805 SOUTH EUCLID • CHICAGO 17, ILL.

MEN! WE FIT
W-I-D-E FEET!

E to EEEE Only
Sizes 5 to 13

Real comfort at last for w-i-d-e feet! We specialize in wide sizes and offer you styles you like to wear but can't find in the width you need. Fine dress shoes, work shoes, casuals, smart hand-sewn genuine moccasins. Top quality. Popular prices.

Money Back Guarantee

Not sold in stores. Write for FREE catalog today. No obligation!

HITCHCOCK SHOES, Hingham 28, Mass.



FREE
CATALOG
Write Today

WILL YOU SMOKE MY NEW KIND OF PIPE

30 Days at My Risk?

By E. A. CAREY

All I want is your name so I can write and tell you why I'm willing to send you my pipe for 30 days smoking without a cent of risk on your part.

My new pipe is not a new model, not a new style, not a new gadget, not an improvement on old style pipes. It is the first pipe in the world to use an ENTIRELY NEW PRINCIPLE for giving unadulterated pleasure to pipe smokers.

I've been a pipe smoker for 30 years—always looking for the ideal pipe—buying all the disappointing gadgets—never finding a single, solitary pipe that would smoke hour after hour, day after day, without bitterness, bite, or sludge.

With considerable doubt, I decided to work out something for myself. After months of experimenting and scores of disappointments, suddenly, almost by accident, I discovered how to harness four great natural laws to give me everything I wanted in a pipe. It didn't require any "breaking in". From the first puff it smoked cool—it smoked mild. It smoked right down to the last bit of tobacco without bite. It never has to be "rested". AND it **never has to be cleaned!** Yet it is utterly impossible for goo or sludge to reach your tongue, because my invention dissipates the goo **as it forms!**

You might expect all this to require a complicated mechanical gadget, but when you see it, the most surprising thing will be that I've done all this in a pipe that looks like any of the finest conventional pipes.

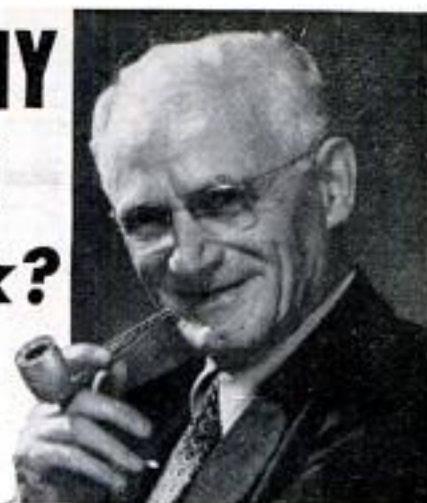

The claims I could make for this new principle in tobacco enjoyment are so spectacular that no pipe smoker would believe them. So, since "seeing is believing", I also say "Smoking is convincing" and I want to send you one Carey pipe to smoke 30 days at my risk. At the end of that time, if you're willing to give up your Carey Pipe, simply break it to bits—and return it to me—the trial has cost you nothing.

Please send me your name today. The coupon or a postal card will do. I'll send you absolutely free my complete trial offer so you can decide for yourself whether or not my pipe-smoking friends are right when they say the Carey Pipe is the greatest smoking invention ever patented. Send your name today. As one pipe smoker to another, I'll guarantee you the surprise of your life, FREE. Write E. A. Carey, 1920 Sunnyside Ave., Dept. 10410, Chicago 40, Illinois

**E. A. CAREY, 1920 Sunnyside Ave.,
DEPT. 10410, CHICAGO 40, ILLINOIS**

Please send facts about the Carey Pipe. Then I will decide if I want to try it for 30 Days at YOUR RISK. Everything you send is free. No salesman is to call.

Name _____

Address _____

City _____ Zone _____ State _____

LEARN MEAT CUTTING AT NATIONAL Pay After Graduation



The steady dependable trade of Meat Cutting taught easily in 8 short weeks. YOU LEARN BY DOING under actual meat market conditions in big modern school at Toledo.

For beginners or men with experience. Get a profitable store of your own. Remember, PEOPLE MUST EAT! Big pay jobs. Free employment help. Thousands of successful graduates.

Buying, cutting, percentage, pricing, advertising, selling, etc. A complete retail meat education. National School established over 30 years. Get National training NOW. Pay your tuition in easy weekly payments

after you graduate. Send coupon for FREE 52 page school catalog — TODAY. G.I. approved.

National School of Meat Cutting, Inc., Dept. 50-K, Toledo 4, Ohio

Send me your FREE school catalog on National Training at Toledo in Meat Cutting, Meat Merchandising and Self Service Meats. No obligation. No salesman will call.

Name _____ Age _____

Address _____

City _____ State _____

Approved for training Korean Veterans

**CAN YOU
GIVE AWAY**

**FREE
HOSIERY?**

How would you like to get paid for giving every man and woman a FREE pair of hose REGARDLESS WHETHER OR NOT FINAL PURCHASE IS MADE? Here is an amazing new plan that is more like a sampling campaign than actual "selling," yet can give you up to \$3 an hour just for your spare time! Imagine showing free stockings included in outfits and saying to any woman: "Will you accept a pair of these beautiful nylon stockings, guaranteed against runs, undue wear and even snags, just to prove how good they are?" Nothing finer made. Knitted of 100% DuPont nylon with 560 needles (each making one stitch) and over 2000 "courses" (rows of loops). Choice of plain or dark seams—latest shades including Red Fox and white—proportioned fit and lengths.



NEW MIRACLE SOCK



Picture yourself showing sample of this sensational sock (included free with outfits) and saying to men: "Here is a new miracle one size, two-way stretch nylon sock that will fit any size foot from 9 to 14. It contains no rubber yet will cling to your foot like a second skin. It never sags or droops, retains its shape and is guaranteed for ONE FULL YEAR! Would you like a gift pair to try out?"

FREE SAMPLES

Buy nothing. Deliver nothing, yet receive advance cash plus huge cash bonus and your own hose as extra bonus. Mrs. J. B. Thurmond, Utah; Ozaki, Ill.; Mattie Sanders, Miss. and others have already earned over \$1,500.00 each. These exceptional earnings show what can be done. Just mail postcard with name and address. That's all. Nothing to pay now or later. You'll receive FREE samples of stockings and new miracle socks with money-making outfits. Absolutely no obligation. Write TODAY.

KENDEX CORP., BABYLON 246, N. Y.

Write Like This

YOUR penmanship can be improved in 3 hours or corrected to your satisfaction in 10 hours' practice with my **DEFINITE HAND CONTROLS**. New way!

WRITE **OZMENT** BOX 665 34-N, ST. LOUIS, MISSOURI

Complete
**OUTLINE
FREE!**



**ITALIAN ACCORDIONS
AT LOWEST
WHOLESALE
PRICES**

**5-DAY
FREE
TRIAL**

**"PAY AS
YOU PLAY"**

Small Down Payment
As Little As
\$10 per
month

**DIRECT from
Importer to You!**

SATISFACTION GUARANTEED, or your money back! NOW you can save up to 50% by direct purchase from America's leading distributor of famous genuine **ITALIAN ACCORDIONS**. TRADE-INS ACCEPTED.

MAIL COUPON TODAY • World's Largest Selection

PLEASE
RUSH
FREE
COLOR
CATALOG

Name _____
Address _____
City _____ Zone _____ State _____

ACCORDION MANUFACTURERS & WHOLESALE OUTLET

2003 West Chicago Ave. Dept. R-104, Chicago 22, Ill.

STAMP COLLECTORS!

322 DIFFERENT STAMPS

25¢

With 8 Exciting Topical Groups

This valuable imported collection includes the **NEW CROATIA U.P.U. SET** of 4, gorgeous South Sea U.P.U. set, Roosevelt Memorial group including scarce underground issue United Nations issue from far off islands, Sports contests from riotous **TRIESTE, TRIANGLES GALORE**, multicolored **BIRDS, Animals, Flowers, PLUS HUNDREDS** of other fascinating issues. A total of 322 all different stamps cataloging more than \$6.50 for only 25¢, to introduce our **FAMOUS BARGAIN APPROVALS**. Money back if not delighted.

FREE: 48 PAGE STAMP DICTIONARY & GUIDE

STAMPEX CO., 116-RM Nassau St., N.Y.C. 38

DR GRABOW PIPES



**\$7.50
TO
\$5.00**

NOW an amazing **\$60.00** course that shows you how to control the greatest power in the world **YOURS FOR ONLY \$3.50** with a 10-day **FREE** examination.

THE KEY TO POWER AND PERSONAL PEACE

By **U. S. ANDERSEN** - The book that shows you how to "Think Big - Do Big" . . . that offers you power you have never dreamed of, peace you have never imagined and a complete understanding of your relationship with the universe and God. For new success, achievement, love, health and vigor - buy it today! Money-back guarantee. Send check or money order for \$3.50, postpaid. (C.O.D. plus postage.) Full refund if not satisfied.

HERMITAGE HOUSE, Dept. 6, 8 W. 12th St., New York 11, N. Y.



TELEVISION! CAMERAMAN, REPAIRMAN

Learn at home, in spare time. No experience needed. We send you 15 Radio-TV kits including TV receiver. Earn while you learn. Write for free TV Book, free sample lesson, etc. **APPROVED FOR VEETS.** **RADIO-TELEVISION TRAINING ASSOCIATION**

Dept. M-10 52 East 19th St. New York 3, N. Y.

CASTING SECRETS REVEALED

Big money! Cast 1000's of plaques, figurines, etc. with X.L. rubber molds. No exper., little capital req. X.L. rubber pts. \$2.50, qts. \$4 (instore extra). Modula, rubber for 3 molds, \$1.50 pcd. U. S. only. Send 25¢ (refundable) for 40 pp fact catalog.

**HUGE PROFITS!
MORE MONEY!**

PLASTIC ARTS STUDIO, Dept. PM2, 3403 S. Madison St., Muncie, Ind.



**BUILD LUGGAGE AT HOME
WE SELL YOUR PRODUCTS!**

ONLY NEW HOME MONEY-MAKING PLAN IN YEARS!

Make Luggage and cases for traveling, photographers, musicians, salesmen, electronics, tools, portables, 1001 other items. Also repair Luggage. No special equipment needed. **BIG Profits.** We supply complete instructions—everything. Write for free details and Business Plan. **ABARSI CASECRAFT, Dept. G-10, 805 W. Sunset Blvd., Los Angeles 12, Calif.**



NEW Crosman

SPORT STYLED AIR RIFLE

Push-button cocking, precision rifled barrel, more hard-hitting power, .22 cal., safety, blued steel finish.

\$14.95

FREE CATALOG

CROSMAN ARMS CO., FAIRPORT, N. Y., Dept. 45



LEARN ANOTHER LANGUAGE

EASILY, QUICKLY, at HOME in 20 Minutes a Day with

LINGUAPHONE

World's Standard Conversational Method

You LISTEN and LEARN to speak:—

FRENCH • SPANISH • GERMAN • RUSSIAN • JAPANESE
MODERN GREEK — any of 29 languages

It's quick, easy, natural... you listen to real life recordings of native men and women making everyday conversation—you understand—you SPEAK! Add to job, armed services, travel opportunities. Save time, work, money. Endorsed by educators; used in colleges and by business firms. Over one million home-study students. FREE BOOK, "Passport to a New World of Opportunity," gives fascinating facts. Write TODAY:

LINGUAPHONE INSTITUTE

143-10 RCA Building New York 20, N. Y.

MAKE MONEY WRITING

short paragraphs!

You don't have to be a trained author to make money writing. Hundreds now making money every day on short paragraphs. I tell you what to write, where and how to sell; and supply big list of editors who buy from beginners. Lots of small checks in a hurry bring cash that adds up quickly. No tedious study. Write to sell, right away. Send for free facts.

BENSON BARRETT

1751 MORSE AVE. DEPT. 27-L CHICAGO 26, ILL.

Watch Repairing Pays Big Money Learn at home



Watch repairers in great demand. Train step-by-step in 10 easy lessons. We furnish all tools and 15 jewel watch and practice movement. Turn spare time into cash. A licensed school. Low cost. Send for FREE book today.

ILLINOIS SCHOOL OF WATCH REPAIRING

2870 Elston Ave., Dept. PM-104, Chicago 18, Ill.

STAMMER?

Get your copy of the new 18th edition of my book, "Stammering, Its Cause and Correction," which describes the Rogue Unit Method for scientific correction of stammering and stuttering. Ask, also, for free SPEECH CHART! Dept. N. Rogue, Dept. 543, Circle Tower, Indianapolis 4, Ind.

GET THIS FREE BOOK!

MAKE YOUR OWN POGO STICK

ALL METAL... SIMPLY AND QUICKLY ASSEMBLED.

Comparable to any \$8. Pogo Stick.

SAVE! Complete kit—Finest materials—ready to assemble. For weights up to 100 lbs. \$3.50. Over 100 lbs. \$4.50 ppd. Specify weight.

U. S. INDUSTRIES, 803 Macy Street, Los Angeles 12, Calif. Dept: PM-104

Learn the Secrets BREED RARE tropical fish

... IN YOUR HOME... SPARE ROOM, BASEMENT, GARAGE... ANYWHERE!

EARN BIG MONEY—SPARE TIME

RUSH this Coupon TODAY!

New "Chance of Lifetime" opportunity! Start your own spare or full time business once you know the revealing breeding secrets. It's fascinating! It's Fun! Breed EXOTIC and graceful "Angel Fish", BEAUTIFUL "Gourami" that are 12 DIFFERENT COLORS, "Fighting Fish" THAT FIGHT UNTIL DEATH; "Danio" that are STRIPED LIKE A ZEBRA, TRANSPARENT FISH—hundreds of expensive varieties. Some fish lay 300 to 600 eggs at one time. (Some very rare fish have sold for over \$75 a pair.) Get into PARTNERSHIP WITH NATURE and let nature multiply your profits for you. NO EXPENSIVE EQUIPMENT—NO EXPERIENCE NECESSARY. WE SUPPLY EVERYTHING YOU NEED. HELP FILL HUGE DEMAND from stores, offices, theaters, hotels, etc. New plan lets YOUR MAILMAN BRING YOU ORDERS. Investigate TODAY.

Tropical Fish Breeders of America, Dept. D-A
15127 S. Broadway St.,
Los Angeles 61, California

Dear Sir:
Please rush me all Free Details.

Name _____

Address _____

City _____

State _____

Your Age _____

FREE! Colorful "How to Do It" success BOOK-LET, REPRINTS, breeding BROCHURE and ALL DETAILS. Rush coupon today!

Proof of tremendous profits!

KIND OF FISH	EGGS OR YOUNG PRODUCED AT ONE BIRTH	APPROX. RETAIL PRICE OF FULL-GROWN FISH
Swordtail	30 to 100	\$3.00 to \$4.00 Pr.
Red Delta	75 to 200	2.00 to 4.00 Pr.
	100 to 150	8.00 to \$1.00 Pr.

own your own business! earn up to \$75 A DAY CLEAR PROFIT in your back yard or basement!

MAKE CONCRETE BLOCKS With Amazing New LOW PRICED GENERAL BLOCK MACHINE

NOW! Big Building Boom Profits Within Your Reach

You don't need much cash to cash in on the building boom! New high speed, low cost General Block Machine produces up to 1,000 concrete blocks a day for homes, factories, buildings, garages. Your profit mark-up is 100% to 150%! Fool-proof, easily operated, sturdy steel machine can make any size from 4" to 12". These superior 3-core blocks meet all building code requirements for foundation, chimney, corner, sash and many other types of blocks. Works indoors or out. Sand, cement and water available anywhere! Simple operating instructions and mixing formulae for cement and cinder blocks supplied FREE. Get full details, no obligation!



R.L.T. of New York City Reports: "My General Block Machine PAID FOR ITSELF IN FIRST 2 WEEKS!"
Thousands now in use the world over! Write for FREE details TODAY

EXTRA!

Amazing illustrated book gives floor plans for 6 sensational concrete block bungalows. Tells how to lay blocks, lay out building lines, mix concrete, build steps, porch and concrete floors all at great savings. Written by experts. Can save many times the cost of the machine! Get it now! No strings attached.

HOW TO BUILD YOUR OWN CONCRETE BLOCK HOME
Only 1 Prep'd

Book sent free if you buy machine. \$1 refunded if you buy later.

GENERAL ENGINES COMPANY

Dept. M-104, 307 HUNTER STREET, GLOUCESTER, N. J.

High School at Home

MANY FINISH IN 2 YEARS

No classes. No time wasted going to and from school. Progress as fast as your time and abilities permit. Standard H. S. texts supplied. Thousands enroll each year in this 57-year-old school. Send for FREE descriptive booklet.

AMERICAN SCHOOL, Dept. H745
Drexel at 58th St., Chicago 37, Ill.

Without obligation, please send FREE descriptive booklet.

Name _____

Address _____

Canadian Residents: Complete Canadian Course Available. Write American School, 1610 Sherbrooke St., West, Montreal.



"I DOUBLED MY INCOME— Am My Own Boss— in CUSTOM UPHOLSTERY"



**Leonard Schroeder, Former Low Paid
Accountant—Increases Earnings 110%**

"I was an accountant earning \$40 a week before getting UTS training in upholstery. As soon as I graduated, I got a much bigger paying job with a firm specializing in custom upholstery work. Now I've better than doubled my income operating my own business."

WHAT DO YOU WANT? Your Own Business—A Steady Job—Substantial Sparetime Earnings—A Better Future? They're all waiting for you in the Big-Opportunity Field of Custom Furniture Upholstery.

AT HOME in spare time, you can do what Leonard Schroeder and other UTS graduates have done — easily, quickly! Trained upholsterers are scarce. You can earn as you learn to make good money all year 'round at home, in your own shop, or in a well-paid job. The practical N.Y. State-Approved UTS course teaches you custom furniture upholstery, reupholstery, slipcovers, furniture finishing, repairs, window cornice, cushion and drapery making. You get—FREE—ALL tools, complete frames, materials and fabrics to make beautiful upholstered furniture and slip covers that are yours to keep or sell! FREE BOOK, "Your New Way to A Successful Career" tells how you prepare at home for this big pay, big opportunity trade. WRITE TODAY! Training in N. Y. School also available. Upholstery Trades School, Dept. CR-305, 721 B'way, N. Y. 3.

Approved for Veteran Training

SEND FOR BIG FREE BOOK

UPHOLSTERY TRADES SCHOOL, Dept. CR-305
721 Broadway, New York 3, N. Y.

Send me your FREE book on:
 Home Study In N. Y. School Training

Name _____

Address _____

City _____ Zone _____ State _____
 Check here if Korean Veteran

WHOLESALE Electric Guitars - Parts - Build Your Own

Accordions, amplifiers, double-necks, triple-necks, pickup mikes, mandolins, non-electric instruments, etc. 1954 Models wholesale. Free Catalog. Free home study course with instruments. Parts and plans available to build your own 6 or 8 string or multi-neck electric guitar. Martin and Fender available at list price.

CARVIN CO., Box 28 PM10, Baldwin Park, Calif.

73

Make Money Manufacturing Concrete Drain Tile



Manufacturers of concrete drain tile are in the driver's seat. Why? Because their basic costs are not burdened by freight, distribution and breakage costs—items which the clay tile people have to pass along. Net results: concrete tile can sell for less, yet show a generous profit.

The market is big—and getting bigger. Not only because of increased farm drainage, but also because drain tile are needed in home building, reclamation projects, highway construction, and many other purposes.

Tile made on the Champion are outstanding in quality—dense, strong, uniform and truly round. All sizes up to 12" diameter. Easy to make, because the Champion Machine is simple, compact, and requires no skilled labor. Business is a low-investment opportunity, with equipment available on terms. Write for catalog.

**CONCRETE EQUIPMENT CO.
522 Ottawa Ave., Holland, Mich.**



**IN CANADA: DUNN MASONRY MACHINERY LIMITED
970 Dundas Highway, Cooksville, Ont.**

MAKE CRIME YOUR BUSINESS

ON THE SIDE OF THE LAW!

Help fight crime! . . . Earn steady good pay as a Finger Print Expert or Investigator. I.A.S. trains you—by easy, low-cost home study lessons. Learn this exciting work in spare time. Write for full details now!

OVER 800 POLICE BUREAUS...

Employ I.A.S.-trained men . . . proof of what I.A.S. can do. Write today (state age) for details. No obligation. No salesmen will call.

INSTITUTE OF APPLIED SCIENCE

(A Correspondence School Since 1916)

1920 Sunnyside Ave., Dept. 1357 Chicago 40, Illinois

SHINE WITHOUT 'POLISH'

Your Shoes Glean Like Mirror



Replaces messy pastes, liquids. Simply glide over shoes—and presto!—you have a lustrous, long-lasting shine. No mess, no fuss. Shoes gleam like mirror. For Men's, Women's, Children's Shoes. Take order! Earn money!

Sample offer sent to all who send name at once. Postcard will do. SEND NO MONEY—just your name. KRISTEE CO., Dept. 680, AKRON 8, OHIO

Learn REFRIGERATION AND AIR CONDITIONING

FREE! PLAN FOR YOUR SUCCESS

EXTRA CASH NOW — Spare time at home — Earn while you learn by doing with Easy Home Course. START YOUR OWN BUSINESS — No Experience Needed. Special tools & equipment furnished. Send for FREE BOOK — TODAY!

**MECHANICS TRAINING SCHOOL—Dept. P-5410
7217 South Broadway • Los Angeles 3, California**

FREE BOOK

I HAVE BEEN AVERAGING \$25,771.16 gross in cash monthly (Dec. \$31,362.14) for two years in mail order business started very limited capital 1950. Because I can't cover even 1% of the market, I can supply you with merchandise, mailing lists, sales letters, advice based on experience. Can be operated on small scale by man or woman. Began in my home, now employ 23. Send one dollar which will be credited to you. My firm belongs to Chamber of Commerce, well rated financially. Not a crazy scheme but a legitimate business. No special education, training required. One dollar brings story. Mail order P.O. Box 1715-D-3, Dallas, Texas.

DAN LURIE

"America's Most Muscular Man"
—on television's "Big Top"

FAMOUS DAN LURIE



BARBELLS

with 4 courses—low factory prices

50 lb. set... \$ 8.48 | 150 lb. set... \$20.48

100 lb. set... 13.98 | 200 lb. set... 25.98

Write for Free Catalog

Order by Mail: 50% with order, bal. C.O.D. Extra wts. 13c per lb., P.O.H. plant

DAN LURIE BARBELL CO.

52-M-10 Bristol St., Dept. 459-K, Brooklyn, N. Y.

BUY IT WHOLESALE!

GET UP TO 40% OFF

Start a Buying Service at Home, SPARETIME, GET BIG-NAME MERCHANDISE FOR SELF AND CLIENTS UP TO 40% LESS THAN REG. PRICE. SALES EASY, AS YOU CAN GIVE SIZABLE DISCOUNTS, STILL MAKE FAT COMMISSIONS. Post Card brings FREE COPY The Wholesale Plan.

FREE! THE WHOLESALE PLAN

American Buyers Service

631-R Linden Ave., Buffalo 16, N. Y.

Learn BAKING At Home

Baking is one of America's high industries in wages. Nearly depression-proof. Thorough basic home course lays sound foundation. If you have aptitude, write for FREE BOOKLET, "Opportunities in Commercial Baking."

NATIONAL BAKING SCHOOL
835 Diversey Parkway Dept. 1357 Chicago 14, Ill.





IF YOU LIKE TO DRAW SKETCH OR PAINT...

You may have talent that could earn you \$75 to \$500 weekly! Trained artists are needed. See if your talent is worth training. Take the famous Art Talent Test, at home, alone, in spare time. Developed by world's greatest home study art school, it's helped thousands toward art careers. No fee or obligation. This coupon brings it. Write today!

ART INSTRUCTION, INC., STUDIO 10134

500 S. 4th St., Minneapolis 15, Minn.

Please send me your Free Talent Test. (Please print)

NAME _____

ADDRESS _____ PHONE _____

CITY _____ ZONE _____

COUNTY _____ STATE _____

OCCUPATION _____ AGE _____

BECOME AN EXPERT IN TRAFFIC

Traffic men earn \$4,000 to \$10,000 and up. Thousands of firms need experts on rates, tariffs, regulations. We train you thoroughly in spare time at home for executive traffic jobs. Personal training under traffic authorities. Placement counsel and help. Write for free 48-page book "Traffic Management—the Fast Growing Profession."

LASALLE Extension University, 417 So. Dearborn St.
A Correspondence Institution Dept. 1084T Chicago 5, Ill.

MAKE MONEY!

Sell Warm
LEATHER
Jackets



Rush Card TODAY for FREE SELLING OUTFIT!
Sell warm leather jackets to truckers, milkmen, gas stations, etc. Men really go for these fast-selling garments of Horsehide, Capeskin, Suede, Nylon, and 100% Wool. Warm quilted linings (for collars). As our men in your community, you make **BIG MONEY** on every sale, yet you don't invest one cent. Rush card **NOW**... start building your own big profit-making business right away.
MASON SHOE COMPANY, Box MA 366, Chippewa Falls, Wisconsin

Stop Making Mistakes in ... ENGLISH!

New CAREER INSTITUTE method enables you to stop making mistakes in English, build up your vocabulary, speed up your reading, improve your writing, acquire the "secrets" of fluent conversation. Good English pays off in unexpected ways because words are the tools of thought. The more you learn about words and how to use them to express your ideas, the better your thinking becomes.

FREE BOOKLET

The improvement of your English—and your thinking—can lead quickly to amazing personal achievements. Thousands of men and women use the low-cost CAREER INSTITUTE method. Takes only 15 minutes a day at home. For FREE 32-page booklet send card or letter. No salesman will call—no obligation.

CAREER INSTITUTE

Dept. D-1110 25 E. Jackson Chicago 4, Ill.

OCTOBER 1954

Say You Saw It in Popular Mechanics

EARN MORE

\$\$\$ \$

THIS 120 PAGE HANDBOOK

FREE!



120 pages of practical guidance to the best paid positions, for men who aren't content to stay "at the bottom". Home Study Courses in all branches of Engineering. How to get rapid promotion. You will find all this, and much more, in "ENGINEERING OPPORTUNITIES"—a book that can MAKE THIS YOUR BIG YEAR.

Civil A.M.I.C.E. Structural Electronics
Mechanical A.M.I.Mech.E. Aeronautical A.F.R.Ae.S.
Electrical B.Science A.M.Brit.I.R.E. Building

MAIL COUPON TODAY

Canadian Institute of Science and Technology Limited
578 Century Building, 412, 5th St. N.W. Washington, D.C.
Please forward free of cost or obligation your handbook, "ENGINEERING OPPORTUNITIES".

Name _____

Address _____

Course _____

Interested in _____ Age _____

FOR YOUR TECHNICAL EDUCATION

COME TO

THE UNIVERSITY OF HOUSTON

(LOCATED IN FABULOUS HOUSTON, TEXAS)

For **SUCCESS** . . . Select one of these fascinating technical fields:

- Air Conditioning and Refrigeration Technology Diesel Technology Drafting Technology Electrical Technology Electronic Technology

Train NOW for the job you want . . . a job with a good income and security. Train at the University's College of Technology . . . rated one of the best in the country:

- Beautiful 250 acre campus • Air conditioned classrooms and Residence Halls • Graduate placement • Short or longer programs • University television and radio station • Opportunity to extend your education and earn a college degree • Accredited curricula • Modern, extensive equipment • Part-time job while in school • Co-educational • G.I. approved—V.A. on campus • Open to high school graduates or equivalent • Aptitude testing and vocational guidance • Feb., June, Sept. semesters.

Send for **FREE** illustrated brochure Now.

Mark X before your choice of subject.

UNIVERSITY OF HOUSTON—COLLEGE OF TECHNOLOGY
DEPT. 1A4 — HOUSTON 4, TEXAS

FREE 1955 CATALOG

WORLD RADIO LABORATORIES

"The World's Largest Distributor of
Amateur Radio Transmitting Equipment."

Jam packed with bargains—
everything in Radio, TV, and
Hi-Fi—for Handyman, Ham,
Experimenter or Serviceman!

- Pay Only 10% Down
- Easy Terms
- Liberal Trade-Ins
- Save Over 50% on Used Equipment
- Over 600 guaranteed reconditioned items.



WORLD RADIO LABORATORIES
3415 W. Broadway — Council Bluffs, Iowa

Leo I. Meyerson

PERSONALIZED SERVICE

MAIL HANDY COUPON

WORLD RADIO LABORATORIES, INC. Dept. PM-10
3415 W. Broadway — Council Bluffs, Iowa 3'x4' U.S.
 Free 1955 Catalog Used Eq't List Radio Map 25c

NAME _____
ADDRESS _____
CITY _____ STATE _____

To Worried Smokers:

Doctors prove pipe smokers live longer!
switch to



LEARN TO **BECOME A GAME WARDEN**
or GOVT. HUNTER. Join FORESTRY, FISHERY, or WILDLIFE Services. Excellent opportunities! Good pay (\$2500 to \$10,800 a year). Pleasant Work, Prestige, Real Security, Healthful Working Conditions, and Retirement Income can all be yours. Help fill the demand in your area. Make your love of the outdoors become your business. Learn at home in spare time—it's Easy! Fun! Fascinating!
FREE! (if over 17 years old.) Complete, illustrated booklet that gives you complete facts. **SUPPLY LIMITED**—send your name and address now—**TODAY!**
HOME STUDY INSTITUTE, Dept. R 10, 3156 W. 8th St., Los Angeles 5, Calif.

High Power BINOCULARS
FREE 14-PAGE BOOK & CHART
Know the facts! Learn meaning of Power, Field, Coating. Latest data. 33 Models sold on
30 DAY FREE TRIAL
\$9.95 UP
BUSHNELL'S, M90 Bushnell Bldg., Pasadena, Calif.

Be a FLORIST Thousands of money making opportunities, full or part time. Many start business in own home. Flower arrangement included to enable you to make profitable corsages, wreaths, sprays, etc. Professional material supplied with Home Study Training. Write for **FREE** Book. **FLORAL DIV.**, National Landscape Institute, Dept. PF-10, 310 S. Robertson Blvd., Los Angeles 48.

NOW! 100 SHAVES from ANY STYLE BLADE
SAVE MONEY! HAVE SHARP BLADES FOR CLEAN CLOSE SHAVES ALWAYS
Just a few strokes on this fine quality razor blade hone sharpens all types of razor blades, single or double edge. Complete with instructions and 25 double-edge surgical steel blades, only
\$1 POST PAID \$1 postpaid. Money-back guarantee. Send \$1 (sorry no C.O.D.'s) with your name and address to
ARCO DISTRIBUTORS, Dept. A, Box 20, Cathedral Station, New York 25, N.Y.

SAY YOU SAW IT IN
POPULAR MECHANICS

BE A CLAIM INVESTIGATOR
INVESTIGATE ACCIDENTS! Many earning \$750 to \$1000 a month. Thousands of insurance companies, airlines, steamship lines and Government Offices need Claim Investigators. Also big opportunities for your own spare time business. We train you at home. National Placement Service **FREE** of extra charge. Bill King writes: "Your course has paid off for me with large earnings. You can quote me—your Adjuster Training Course is worth many times the cost." Write **TODAY** for **FREE** book.

UNIVERSAL SCHOOLS
University Park, Dept. 110, Box 8202 Dallas 5, Texas

POPULAR MECHANICS



NEW TYPE BATTERY makes 100,000 STARTS per MONTH month after month!

PATENT PENDING
#408439



"TORTURE TESTS"

by authorized member of American Council of Commercial Laboratories demonstrate amazing performance[®] of Life-Long—the only battery in the world with a TEN-YEAR BONDED GUARANTEE featuring free replacement or money back. These independent laboratory reports prove what you yourself will soon discover in your own car... that your Life-Long Battery gives you faster starts, a hotter spark, brighter lights, sure starts in any weather, ample power for extra electrical equipment.

*Let us send you details of these independent laboratory tests.

OVERCHARGE TEST... Life-Long exceeds SAE requirements by 400%, eliminating all possibility of burn-outs through overcharge.

R.P.M. TEST... Life-Long spins your engine 20% faster.

COLD TEST... Life-Long operates efficiently at 70 degrees below zero

HIGH TEMPERATURE TEST... Life-Long operates efficiently at blistering temperature.

10 YEAR Bonded Guarantee

BACKED BY GREAT WESTERN
ESCROW COMPANY
BOND

A Completely
Rundown
LIFE-LONG BATTERY
will Recuperate in
"ONE MINUTE"

*I will pay you
\$1,000 if you can
disprove this claim!*

J. M. Watt
PRESIDENT
LIFE-LONG BATTERY MFG. CORP.

TRY IT!

Tremendous RESERVE POWER

Insures You a TROUBLE-FREE BATTERY!

You insist on "reserve" horsepower in your motor. You need extra emergency power in your battery, too, as insurance against costly, embarrassing battery failure. You get that reserve power with Life-Long—the only battery backed by a 10-year Bonded Guarantee.

LIFE LONG

Large corporations, Fire Departments, Police Departments, Taxicab Companies in every part of the country, as well as the U. S. Government and many foreign countries are now buying LIFE-LONG BATTERIES. • LIFE-LONG manufactures a complete line of Industrial, Commercial, Marine and Motorcycle batteries. Prices on request.

COSTS NO MORE

You Can Now Buy a LIFE-LONG TEN-YEAR BATTERY for less than the cost of an ordinary lead acid battery. Look at the money you save!

All 6-volt
LIFE-LONG AUTO BATTERIES—\$29.95

All 12-volt
LIFE-LONG AUTO BATTERIES—\$34.95

A so-called "First Quality" three-year battery costs you \$10.00 a year. A LIFE-LONG TEN-YEAR BATTERY costs you only \$3.00 a year.

With your ignition switch off and your headlights on, step on your starter until the battery is so run down that it won't start the engine or light the lights. Now wait one minute with headlights off—then step on the starter. The LIFE-LONG BATTERY will start your car instantly with a surge of power that it has regained during that brief 60-second interval! Make this test as many times as you like! One LIFE-LONG dealer has demonstrated this amazing recuperative ability of LIFE-LONG BATTERIES over 500 times with the same battery, with no sign of weakening, yet!

IF NO DEALER NEAR YOU, USE COUPON

BUY NOW! UNDER MONEY-BACK GUARANTEE

DISTRIBUTOR TERRITORY OPEN

Life-Long Batteries, sold all over U. S. and abroad, are protected by exclusive patents. Some territories are still open for men who recognize this big profit opportunity. Write for details.

LIFE-LONG BATTERY MFG. CORP., DEPT. 10-PM
11766 W. Pico Blvd., Los Angeles 64, California
Please ship Life-Long Battery, 10-year guarantee:
6 volt automotive battery (\$29.95 including tax)
12 volt automotive battery (\$34.95 including tax)

for _____
Make & Model, Year of Car _____
Cash, check or money order enclosed. Life-Long pays all delivery costs to your door.
Name _____
Address _____
City _____ Zone _____ State _____

Reader's Digest

Write to Life-Long for a free copy of a Reader's Digest article entitled "THE U. S. FINALLY DISCOVERS THE LIFETIME BATTERY."

Copyrighted material

MEN-WOMEN GROW
ORCHIDS
IN YOUR LIVING ROOM!

Any Climate - Maine to California
 YEAR 'ROUND No Equipment Needed

BIG PROFITS SPARE OR FULL TIME



Fill your home with gorgeous Orchids. Huge purple Cattleyas, exquisite Cymbidiums - dozens of others! Many grow without soil, getting food from the air. White Orchids, yellows, greens, every rainbow color. No equipment needed. Start on table or window ledge.

SUCCESSFUL HOME GROWER SHOWS YOU HOW! Complete instructions show you step-by-step how he and his wife started with a few plants and developed a big-profit home-business - grew an Orchid collection now worth a fortune. Learn how orchids multiply, how one plant may become many, each as valuable as the first. No big investment or overhead. Takes but a few minutes a week.



Orchids have rewarded me richly - thanks to Tropical Flowerland.
 E. V. SMART - Colorado

Big-profit orders for plants and flowers come from individuals, florists, hotels, clubs, etc. Year 'round gift. Millions sold by Mail-Order.

COMPLETE INSTRUCTIONS AND BLOOMING-SIZE ORCHID PLANT SENT FOR YOU TO EXAMINE AT HOME WITHOUT RISK. Secrets of the experts in simple language, jam-packed with "show-how" drawings, magnificent full-color pictures of Orchids. Send No Money! Write NOW for your FREE FACTS that show you how to learn to grow Orchids at home. Airmail is quicker.

TROPICAL FLOWERLAND, Dept. 31A
 4622 Wilshire Blvd., Los Angeles 5, Calif.

Turn your Electronic know-how into BIG MONEY

as an INDUSTRIAL Electronics Technician

Electricians, radio technicians, and experimenters - Good paying jobs are waiting for YOU - installing and maintaining the increasing number of electronic control devices in industry. Cash in on your background NOW... let this practical library help you!

Here are the facts to help you turn your experience into a better-paying career!

PRACTICAL INDUSTRIAL ELECTRONICS LIBRARY

4 volumes, (1390 pages, 1050 illus.)

Chute's Electronics in Industry

Miller's Maintenance Manual of Electronic Control

Markus & Zeluff's Handbook of Industrial Electronics Circuits

Henney & Fahnestock's Electron Tubes in Industry

NOW! Cash in on your knowledge of electronics! Plants are adding more electronic devices daily - they need men badly to keep these devices in top working order. This data-packed library shows YOU how to set-up, service, and repair a plant's electronic equipment; how to locate and correct tube and circuit troubles, etc. Includes trouble-shooting charts, tested working methods, step-by-step directions. Add this wealth of factual knowledge in what you already know about electronics - and you'll have a head start in this booming field! Mail coupon TODAY for FREE TRIAL.

McGraw-Hill Book Company, Inc., Dept. PM-10
 327 West 41st St., New York 36, N. Y.

Send me for 10 days' FREE EXAMINATION the Practical Industrial Electronics Library. In 10 days I will send \$2.50, plus small delivery charges. Then \$4.00 a month until \$22.50 is paid. (A saving of \$3.50 under regular price of \$26.00) Otherwise I will return books postpaid.

(PRINT) Name _____
 Address _____
 City _____ Zone _____ State _____
 Employed by _____ PM 10

WE'LL PAY DELIVERY if you remit (check or M.O.) with coupon. Same refund privilege. Offer applies to U. S. only.

STOP TERMITES Yourself
 at a big saving - with amazing new product, ARAB U-DO-IT

Kill subterranean termites yourself by the modern, soil-treatment method. ARAB U-DO-IT is a liquid concentrate with a Chlordane base. One gallon, for 19.95, mixed with water makes 100 gallons ready-to-use termite killer and will treat average 5-room house. Easy to apply. Will not harm grass, flowers, shrubs or trees. Long-lasting effectiveness proved since 1946 by leading exterminators. If your dealer cannot supply, send postcard for prices and FREE folder showing how termites get into your house, where to look for them, how to kill them. No obligation.

FEDERAL CHEMICAL CO., Dept. PM-104, Indianapolis 5, Ind.

SEND FREE!

Make money. Know how to break and train horses. Write today for this book FREE, together with special offer of a course in Animal Breeding. If you are interested in Galting and Riding the saddle horse, check here () Do it today - now.

BEERY SCHOOL OF HORSEMANSHIP
 Dept. 11010 Pleasant Hill, Ohio



BARGAINS IN BOOKS

Save money on latest best-sellers of all publishers. Also old-time favorites. New 60th annual catalog lists 25,000 books on Fiction, Reference, Juvenile, History, Religion, Science, Child Guidance, etc. Send post card today for FREE copy of 1955 catalog, "Bargains in Books."

THE BOOK SUPPLY COMPANY, Dept. 22
 364-566 West Monroe St., Chicago 6, Ill.

RUPTURED?

Something different. Light. Cool. No leg straps. No elastic. No pressure on hips or spine. Inexpensive. Worn by Mechanics, Farmers, Doctors, etc., everywhere. Guaranteed. Write

HAND-LOCK PRODUCTS
 EST. 1893 DEPT. PM, PRESTON, ONT., CAN.

Buy Nationally Known Brands
WHOLESALE! DIRECT! SAVE to 66 2/3%!*

- APPLIANCES
- WATCHES
- CAMERAS
- SPORTING GOODS
- AUTO SUPPLIES

OWN YOUR OWN BUSINESS!

- No Investment!
- No Inventory!

Write for FREE Brochure

NATIONAL BUYERS SERVICE, P.O. 426, OAKLAND, CALIF.

BAZOOK Hi-Power SLING GUN for HUNTING & TARGET



Pat'd 1953
\$1.50 PPD.
 No COD

PISTOL ACCURACY with Arrows, Steel Balls, shot loads, etc. **SAFE INDOOR** using soft clay pellets - no rebound. **GUARANTEED** for long, rugged use. Extra rubber & ammo. incl. Also **FREE PLANS!** Now you make your own Hi-Power Sling Hunting Rifle - it's easy.

500 Steel Balls \$1.00
UMAKO PRODUCTS, PO Box 4133-M, Long Beach, Calif.

Say You Saw It in Popular Mechanics

PROTECT YOUR EYES! NEW GOGGLES
 (YOU HAVE JUST TWO TO LAST A LIFETIME)

Now... for a new low price, you can shield your eyes against the hazards of flying particles from lathes, grinders, drill presses, etc. A fine one-piece, full-view goggle - beautifully produced of clear plastic - yours for only \$1.75, plus 15c for postage and handling! A Perfect Goggle For a Workshop & Machine Shop & Farm & Skies & Motorcycles & Road Graders & Miners & And Many Others. Adjustable head band holds firm-fitting goggles comfortably for hours. **ORDER YOUR GOGGLES TODAY!** Send cash, check or money order for prompt delivery. Moneyback guarantee.

CRAFTLINE, P.O. Box 9197-M, Richmond 27, Va.



ONLY \$1.75
 Plus 15c Postage

NEW!
* LIQUID SLATE TURNS
ANY SURFACE INTO
A BLACKBOARD!

Goes On Like Paint!
ONLY \$1.50
PPD.
(Enough for 20 sq. ft.)

Now make your own permanent blackboards! "Paint a slate" right up on any wall, or inside any closet door in home, shop, factory, office! Amazing new "Liquid Slate" goes on wood, metal, glass, hard-board, plaster, plastics, anything! Dries a washable "eye-ease" green or black. Erases like any slate. Just 1 coat lasts years. Order now! Please specify color.

Enclose check or M.O. Money-Back Guarantee.
Send for Free Booklet of Blackboard Ideas!
BEDFORD TECHNICAL, P. O. Box 46, Dept. 79, N.Y.C. 67, N. Y.

ADDING MACHINE *DIALS like a PHONE*

• Fast • Accurate • Dials the Answer • Adds and Subtracts Up to a Million • A Ruler • Flat • No Moving Parts • Fits into Pocket or Purse • Fully Guaranteed • Nothing to Learn • Start Using Right Away! \$1.00 plus 25c post and handling charge.

M-10m UNIVERSAL MAIL MART, Inc.
27 East 22 St., New York, N. Y.



LAW FREE BOOK

Write today for FREE book, "THE LAW-TRAINED MAN," which shows how to learn law in spare time through the famous Blackstone home-study course in business and professional law. All instruction material furnished including his 16-rol. law library, Bachelor of Laws (LL.B.) degree awarded. Moderate cost; easy terms. Write today.

Blackstone School of Law, 225 North Michigan Ave.
Founded 1890 Dept. 57, Chicago 1, Ill.

PORTABLE GARAGE
\$6.75 (Former Price \$10.00)

USE IT ANYWHERE

- Folds compactly • Keeps rain, snow, dust, salt air, sun away
- Protects your car's finish • Durably constructed of vinyl plastic
- Sprung into classified bottom, holds securely • Fits all makes
- Direct from MFG. • Enclose payment of \$6.75 plus 8.35 postage or send C.O.D. 10-Day Money Back Guarantee.

EXTRA HEAVY GARAGE \$8.95 (Formerly \$12.00)

MARDO SALES CORP.
480 LEXINGTON AVE., DEPT. MG-2, NEW YORK 17, N. Y.



Learn ELECTRIC APPLIANCE REPAIR AND SERVICE

FREE! PLAN-FOR YOUR SUCCESS

BIG PROFITS - BIG DEMAND for qualified men in field of Home Freezers, Washing Machines, Dishwashers, House wiring, Auto electricity, etc. Learn at home - start your own business. NO PREVIOUS EXPERIENCE NEEDED. Special tools & equipment furnished. Earn while learning. Write for YOUR FREE SUCCESS PLAN - ACT NOW!

PACIFIC TRAINING SCHOOL Dept. P-5410
7217 South Broadway • Los Angeles 3, California

FREE BOOK

WANT TO Write Stories

FREE BOOK tells how you learn at home

Articles & Mysteries?

Would you be willing to spend a few hours a week learning to write so you may earn \$300-\$1200 a year part-time? Or many thousands full-time? FREE book, "Art of Writing Salable Stories," and actual lesson material tell how to get started writing short stories, radio-TV scripts, articles, business items. Many students earn while learning. Endorsed by famous authors, scores of successful graduates: approved for veterans. Send today for FREE book and lesson material. Clip this reminder ad.

PALMER INSTITUTE OF AUTHORSHIP, Since 1917
1680 N. Sycamore Hollywood 28, Calif. Desk T-104



The WONDERS of LIQUID PLASTICS

MANUFACTURE WITHOUT TOOLS OR MACHINERY

No previous experience or special ability required! NO TOOLS OR MACHINERY required... the entire process is about as easy as pouring water out of a glass! The WONDERS OF LIQUID PLASTICS make all this possible! Many of the products made with our liquid plastics serve so many diverse and useful functions, many can so easily be converted into beautiful and attractive products that thousands of our customers are now actively engaged in a wide variety of novel and profitable businesses established with the aid of our products and instructions!

UNLIMITED POSSIBILITIES

Work with LIQUID IVORY, LIQUID GLASS, LIQUID MARBLE, LIQUID EBONY, LIQUID PINK CLAY, LIQUID WOOD, LIQUID GEMSTONE, and many other LIQUID PLASTICS and in a matter of minutes turn them into an endless and valuable procession of beautiful imbedded jewelry, novelties, ornaments, statuettes, bookends, lamps, pensets, lighters, ashtrays, keychains, figurines, curios, SOUVENIRS, art and gift products, fishing lures, BOATS, GADGETS galore, exquisite GIZMOS! Make pens, tools, dies, forms, handles, dials, knobs, MACHINE PARTS, models of inventions, pistol grips... the list is endless! The only LIMITATION is your IMAGINATION! Liquid Plastics are the blessing of every creative and ambitious person... with these materials ANYONE can create and manufacture by the THOUSANDS and at a tiny fraction of what it would cost by any other method! Just send 25c and we will send you our big combination Instruction-Catalog describing all of the products mentioned above and the methods of use! You'll readily admit it's the most fascinating book of its kind as far as opening new worlds of activity and opportunities for you! Send for it today.

PLASTICAST CO., (Dept. C)
P.O. Box 6737 (Write to P.O. Box 987
Chicago 80, Ill. either address) Palo Alto, Calif.



FREE!

This highly instructive book will be sent FREE only to those serious inquiries requesting our Instruction-Catalog (25c). No postcards, please.

PLASTIC LAMINATING

This remarkable Plastic Laminating Machine will earn \$18.00 an hour right in your kitchen! Big profits laminating Business, Social Security, Identification, Credit CARDS of all kinds, photos, passes, clipboards, plaques, etc. Prices from \$25.00 and up. Easy terms. Will accept any equipment in trade. Literature free.

PLASTICAST CO.
(See addresses above)



WORK FOR THE

RAILWAY POSTAL CLERKS

CLERKS

CITY CARRIERS

GOVERNMENT

START AS HIGH AS \$4,205.00 YEAR

Many Appointments To Be Made. Experience Usually Not Required. MEN-WOMEN. Mail Coupon Today-Sure.

FRANKLIN INSTITUTE, Dept. T 83, Rochester 4, N.Y.
(Not Government Controlled) First Dash FREE!
(1) 36-page book with list of U.S. Gov't Jobs.
(2) Tell me how to get one of these jobs.

Name _____ Age _____
Address _____



Your Own
Direct Mail
Department
in a
\$19⁹⁰
Package

the Heyer dupli-kit

PORTABLE PRINTER and PORTABLE ADDRESSER



Ideal for Club, School, Church Mailings . . . Mail Order and Business Promotions.

Printer performs a multitude of small duplicating jobs—advertising postcards, notices, reminders, inventory and record cards, etc.



Addresser accommodates 250 addresses on a single roll . . . prepare as many rolls as you need. Loads like a camera, addresses fast and easily, prints on anything mailable, on any size piece. Both are constructed for hard usage, trouble-free operation. Both are complete with spirit fluid and supplies.

Write for further information.

Printer or Addresser may be purchased separately at \$10.95 ea. Sold by leading Stationery and Office Equipment Dealers. If your local dealer doesn't stock, send money and order direct to:

THE HEYER CORPORATION 1856 S. Kostner Ave.
Chicago 23, Illinois
FOR CANADIAN PRICES—CONTACT BROWN BROS., LTD., TORONTO

BUILD your own TV Set

YES. Build your own top-quality TV Set. We supply complete equipment, tools, instruction as part of America's finest Home-Study TV Course. Be a highly-paid TV Technician. Install, Repair, Service all makes of sets. No experience needed. Many excellent jobs now open. Or start your own business. Send today for big FREE Book, "You and Television."

COMMERCIAL TRADES INSTITUTE
Dept. P2-10 1400 Greenleaf Ave. Chicago 26, Ill.

SAVE UP TO **50% & MORE!**

GENUINE DIAMONDS

Buy diamonds and diamond jewelry half-priced from Kaskel's, America's foremost Pawnbroker. Every diamond is re-set in a luxurious new mounting . . . graded according to nationally accepted standard . . . and bonded to this effect. For over 70 years, we've served over 1,000,000 satisfied customers from all 48 States.

10 DAY UNCONDITIONAL MONEY-BACK GUARANTEE.
References: Your bank, or any Rating Agency.

FROM NEW YORK'S LEADING

PAWNBROKER CATALOG

KASKEL'S 41 West 57 St., Dept. 407K
New York 19, N. Y.

Send FREE CATALOG and Advice about DIAMONDS without obligation.

NAME _____

ADDRESS _____

CITY _____

STATE _____

SEND FOR BIG
FREE
ILLUSTRATED

START YOUR OWN BUSINESS Spare or Full Time

BIG PROFITS Assembling and Installing Buckeye Combination Storm Windows and Doors—Glass and Screens

- Factory-to-you in knock-down form
- Redwood or aluminum—all sizes
- Glass and screen interchangeable
- Each size packaged separately



Be your own boss . . . with a stable business! Start with only \$6.65—sell from sample. Ready market at \$22.00 each. No special know-how, tools or inventory needed. Order as you sell. Thousands sold past 20 years. Write TODAY

You Pay Only
\$6.65

Redwood 20 1/2" x 24 1/2"
(Aluminum slightly higher. Buy glass or screen locally.)

Buckeye Screen & Weatherstrip Co.
1380 S. 22nd St. Columbus 7, Ohio

NEW! IMPROVED SUCTION CELLAR DRAINER



PUMPS 300 GALLONS AN HOUR!

DRAINMASTER takes the curse out of basement flooding problems. Operates on normal city water pressure. Electric power failure is no problem. Made of "life-time" solid brass, no moving parts to wear or adjust. Just connect to a handy faucet with garden hose, turn on faucet and DRAINMASTER is working. Flood water is removed Right Down to the floor, no sump needed. Many other drain and pumping jobs are "back-soup" for DRAINMASTER . . . at your favorite Hardware Store, or add 30c for handling and postage. **\$1.95** and we'll rush DRAINMASTER to your aid. Write To: M. P. WHITE CO., Dept. 3-PM, 55 Stuart St., Boston 16, Mass.

USE THIS PORTABLE SHOWROOM

TO START YOUR OWN BRAND NAME BUSINESS!

Impart your own name on this catalog. We'll be your warehouse for 1001 nationally advertised items including APPLIANCES • JEWELRY • RADIOS • CAMERAS • TOYS • ETC. Separate confidential price list. SEND FOR FREE CATALOG TODAY!



O. FAUST, Dept. PM 1054 223 N. 8th St. • PHILA. 6, PA.



Bar Bells

Buy Direct From Factory **\$8.95** up
Write for free booklet and price list.

INDEPENDENT IRON WORKS
2416 East 23rd Street, Dept. B
Los Angeles 58, Calif.

BE A LANDSCAPE CONTRACTOR

Make \$20 to \$60 a day. Millions of new and old homes, estates, etc., need modern landscaping. Easy-to-follow Home Study Course. Hundreds of successful graduates. Write for FREE BOOK.

NATIONAL LANDSCAPE INSTITUTE
310 S. Robertson Dept. P-10 Los Angeles 48, California

EARN
\$300.
BONUS

We will pay up to \$300.00 for information concerning new sources of scrap magnesium which we can buy on a contract basis. Any type of scrap magnesium—borings, shavings, cuttings—scrap magnesium in any form. Many plants today use magnesium and then throw the scrap away. Maybe yours does. Investigate and write today and you may qualify for a bonus of up to \$300.00.

STANDARD MAGNESIUM CORP.
6950 East 41st Street • Tulsa, Oklahoma

250 POWER . . .



Complete Telescope Lens Kit **only \$3.49** postpaid

Conquer Space. Explore the Universe. Planets. Moon Craters. New Stars, etc. Complete Lens Kit consists of 60 inch focal length ground and polished objective lens, eyepiece lenses for 50 POWER, 100 POWER, 150 POWER, 200 POWER, 250 POWER, and all necessary lens fittings. Easy to make from simple step by step instructions. (Tripod and mount not included.) Money back guarantee.

BUSSE SALES CO., Hartford, Conn., Dept. PM 26



FREE-VALUABLE U.S.A. STAMPS!

Scarce genuine postage stamp, as illustrated, picturing first U. S. A. (issued in 1847!); PLUS big collection of 30 all-different United States; 15th century, valuable \$5.00 stamp, etc.; PLUS packet beautiful **Commemoratives** including 1890 Columbian, Boy Scouts, Wild West, many others. Big illustrated U.S. catalog included if you send today! **EVERYTHING for 10c** to cover mailing expenses only! Approvals. Act at once! **H.E. HARRIS & CO., 61 Transit Bldg., Boston 17, Mass.**

WHAT TREASURES WILL YOU FIND?



Exciting Treasure Hunt! More than 1,000 stamps from over 30 countries in Asia, Africa, Europe, etc., unsorted, unsorted, just as received from foreign missionaries, banks, etc. Nobody knows what's inside! Guaranteed worth over \$10.00 at Standard Catalog prices or money back. **ONLY \$1.00.**

H.E. HARRIS & CO., 750 Transit Bldg., Boston 17, Mass.

New World Adventure Catalog FREE

Things of interest to students, explorers, experimenters, travelers, readers, and those who want to know more about the world around them. Get more fun and adventure from life. For those with intellectual curiosity. Catalog of articles, films, kits, records, educational materials, sets, guides, directories and books. Also helps for vocational guidance, personality aids, intelligence & aptitude tests, consumer buying help, etc. Includes science kits, display sets, nature specimens, travel guides, pictorial wall charts, maps, language records, bird song records, outline guides to almost every subject, experimental sets, unusual records & music helps, models of pre-historic animals, star globes, list of low-priced non-fiction paper covered books, etc., etc. Send name & address with stamp or coin for postage.

WORLD OF ADVENTURE, Dept. 106, Ann Arbor, Michigan

ATTENTION GOLFERS!

Why leave good golf balls in water hazards? Save 3 or 4 balls and you've paid for a **LONBILL Retriever**, Aluminum sections 3 ft. long with sturdy fabric cup. Remove cup, tie on a line and go fishing. Satisfaction or your money back. **PRICE: \$2.95 for 6 ft.—\$3.95 for 9 ft.** Postpaid in U.S.A. (No C.O.D. orders). Send check or money order to: **LONBILL MFG. CO. 6044 E. Ninth St. Indianapolis 19, Ind.**

BEING PUSHED AROUND??



Why take any more nonsense from bullies, wise guys and other pests? The next time they try to act smart—give them the surprise of their lives! It's easy when you know **POLICE JIU JITSU!** This complete, fully illustrated course comes to you in one volume. The same as taught to police, magistrates, "G.I." men, soldiers, sailors and members of the U. S. Coast Guard. By all means, just pin \$1 to this ad and we will send **POLICE JIU JITSU** to you postpaid by return mail. Satisfaction guaranteed or your money back.

BOOKS PUBLISHING CO., AMITYVILLE, N. Y.



SHARPEN DOUBLE BLADES

30 SLICK SHAVES FROM EVERY BLADE
Not \$35! Not \$40
"Blade Master" is ONLY **\$2.95** Postpaid
GUARANTEED TO WORK
PERFECTLY OR MONEY BACK
New blades honed smoother, sharper! Old blades made like-new in 10 seconds. Easy! Simply put blade inside "Blade Master" . . . its rotary, miracle honing action conditions all four sides at once. Enjoy weeks, months of barber-smooth shaving delight from every blade. (No COD). We pay postage.

DONALD CAMPFIELD, Dept. M, 14 Beaufort Circle, Springfield, Mass.

Say You Saw It in Popular Mechanics

FORTUNES IN EXPIRED PATENTS

1029 Patents Now Legally Available for Your Own Use!

- Revealing Formulas
- Many New Inspirations
- Manufacturing Means
- Improvements & Perfections for Your Own Ideas and Methods

Yes, our Bulletin brings you 1029 Titles of Expired Patents—a Mine of Unclaimed Fortunes! Men with vision, who look to the future, plan ahead through the Bulletin of Expired Patents.

Only \$2.00, Send for Your Copy Today to:

NEW YORK RESEARCH BUREAU

220 Cabrini Blvd. Dept. M-10 New York 33, N. Y.

HANDY NEW ITEM

Get that last bit

- of TOOTH PASTE
 - SHAVING CREAM
 - SHAMPOO
 - FIRST AID REMEDY
- with



FLO-RITE TUBE DISPENSER

CONVENIENT. Flo-Rite ends all fumbling, mess, waste.

ECONOMICAL. One touch! Right amount dispensed immediately.

READY TO MOUNT! No screws! No nails! Up in seconds with GP pre-set adhesive pads. Takes all regular size tubes.

Introductory offer, \$1.00 ppd. Order now!

No COD's please. Address **FLO-RITE, P. O. Box 87, Dept. 104, Newark, California.** DEALER INQUIRIES INVITED

MADE OF REYNOLDS ALUMINUM

PREPARE FOR BETTER JOB, BIGGER PAY IN SPARE TIME AT HOME

Today, choose the job you want—and prepare for it in time you might otherwise waste. Or if you are already in the work you like best, start training now for quicker promotion and increased pay. During more than 50 years **AMERICAN SCHOOL** has helped ambitious people to reach higher goals. Check subject that interests you and mail coupon for full information.

AMERICAN SCHOOL, Dept. G745, Drexel at 58th, Chicago 37, Ill.
Without obligation, please send **FREE** and postpaid, full particulars about the subject checked below.

<input type="checkbox"/> Accounting	<input type="checkbox"/> Plastics Engineering
<input type="checkbox"/> Air Conditioning	<input type="checkbox"/> Plumbing—Practical
<input type="checkbox"/> Architecture & Building	<input type="checkbox"/> Private Secretary
<input type="checkbox"/> Automotive Technician	<input type="checkbox"/> Refrigeration
<input type="checkbox"/> Better Fellowship	<input type="checkbox"/> Retail Merchandising
<input type="checkbox"/> Bookkeeping	<input type="checkbox"/> Salesmanship—Outside
<input type="checkbox"/> Business Management	<input type="checkbox"/> Sheet Metal Work
<input type="checkbox"/> Contracting	<input type="checkbox"/> Tool Making
<input type="checkbox"/> Diesel Technician	

NAME: OCCUPATION:
HOME ADDRESS: AGE:
CITY: STATE:
Canadian Residents: Write American School, 1610 Sherbrooke St. West, Montreal

MAIL COUPON NOW

BIG MONEY FOR YOU IN

LIVING DWARFED TREES



PLUM TREE

(Ming Trees)

A WORLD WONDER!

Secret Can Now Be Yours!

Only 12" High



Most Carefully GUARDED SECRET IN THE WORLD!

Now—the age-old Oriental secret of growing miniature (Ming) trees can be yours... start you a new, fascinating, fabulously profitable adventure! Grow tiny dwarfed trees of all kinds—fragrant fir and pine, spreading Chinese Elm, even fruit trees—apple, peach, plum, etc.—that *actually bear* tiny, delicious fruit! These incredible living miniature trees—a symbol of divine power to Oriental royalty—were forbidden for centuries under pain of death to “commoners.” Just a few years ago, they were seldom found in the U.S. outside of museums. Well-formed specimens have sold for \$1000, even \$2000 and more!

NOW! LIVING MINIATURE TREES AT ONCE!

You can grow them yourself in just a few minutes per week—at a cost of only pennies per tree. Tremendous profits in your own neighborhood offering gorgeous miniatures that actually live and bear fruit. \$25, \$50, \$100 and more per tree is easy to get, and you pocket all the profit. You can have living growing trees to sell almost at once. Amazing new process permits you to see results immediately. No waiting months or years. What's more, you can have TWO incomes instead of one—don't have to quit your present job.

NO PREVIOUS EXPERIENCE NEEDED

Men—Women, yes, even Children—with our plain-as-day instruction can easily grow living MING TREES. A corner of your living room or dining room, a small part of your service porch, a basement, a garage, even a window sill, is all the room you need. No costly leases to sign, no big overhead. No high salaried employees.

HELP US SUPPLY THE BIG MARKET

- FROM—STORES • CLUBS • HOTELS • FLORISTS • HOBBYISTS • HOME OWNERS • INTERIOR DECORATORS • COLLECTORS

Everyone wants LIVING Ming Trees



We'll send you everything to examine—then you make your decision. You'll receive complete step-by-step, easily understood, illustrated instructions—all the secrets of living, growing MING TREES, plus a complete kit of everything you need to start your own living miniature garden at once. Mail coupon now for FREE EXAMINATION request and all details. Do it NOW—BE FIRST in your area to fill the huge demand!

NATIONAL NURSERY SUPPLY CO.
8463 S. Van Ness Avenue, Inglewood 4, Calif.

FREE! Genuine Seed and Plan

National Nursery Supply Co., Dept. M-10
8463 S. Van Ness Avenue, Inglewood 4, California

Gentlemen: I have heard of live MING TREES but I have never seen one. Yes, I would like to have one in my home and I think they would really sell. Please rush me all the FREE FACTS and FREE SEED at once. Remember, I am under no obligation NOW or EVER.

Name _____
Address _____
City _____ Zone _____ State _____



FREE! ELIZABETH II EMPIRE STAMPS

and illustrated booklet



We'll send generous collection of hard-to-get (mint and used) Elizabeth stamps, Coronation and others — Falkland Islands, Ceylon, Seychelles, South Africa, Tristan da Cunha — many others. PLUS! FREE copy "Stamp Collectors Guide"! — FREE color copy World's Rarest Stamp! Other offers for your free inspection. Rush name, 10¢ for postage and handling — *limited time offer!* GARCELON Stamp Co., Dept. 10TM0, Calais, Maine.

BENJAMIN SUPER CO₂ GAS CARBINE—\$16.50

NEWEST TARGET RIFLE—22 IDEAL FOR SMALL GAME



ECONOMICAL SAFE-NON-TOXIC ACCURATE-CONVENIENT PRACTICAL. Easy to operate—No spring recoil—No pumping. Uses low cost Soda Cartridges Cal. .22 Benjamin H-C Pellets and Darts.

Benjamin CO₂ Gas Pistols Also Available

WRITE FOR FREE ILLUSTRATED FOLDER OF ALL MODELS BENJAMIN AIR RIFLES AND BENJAMIN AIR PISTOLS BENJAMIN AIR RIFLE CO. 896 MARION ST., ST. LOUIS 4, MO. U.S.A.



You're Right!

NOBODY LIKES TO ADD & SUBTRACT FRACTIONS Get a Fractionator \$1.00 POSTPAID U.S.A.

Direct reading. Answers in Fractions & Decimal Equivalents. 100% Accurate. Handles all Engineering Fractions.

DIALS LIKE A TELEPHONE Chas. E. Wells • Box 25-A • Montrose, Calif.

ITALIAN ACCORDIONS



Piano and Chromatic—Vienna & Italian System. Heligons-Irish-Club Models—Hohners & all button type. Also Concertinas and Bandonions. Buy direct from Factory Representative at Lowest Wholesale Prices and Save Money. We take any instrument in trade. Expert Repairing.—Write For Free CATALOG.

ITALIAN ACCORDION MFG. CO. 7600 Cottage Grove Ave., Dept. PM-10, Chicago 19, Illinois



ROVER THE SMOKING DOG

is the newest Scientific Novelty that will fascinate you and your friends for hours. Just insert cigarette in his mouth and watch Rover puff away, he even blows Smoke Rings. Comes complete with pack of cigarettes. You get 2 for \$1.00 postpaid. Write for Catalogue.

Free Xmas Novelty NOVELTY MART, 59 E. 8th St., New York 3, N. Y. Dept. 376

NOW! USE YOUR WILLYS OR DODGE AS BOTH A 2 and 4 WHEEL DRIVE



Enjoy 2-wheel drive pep, speed, extra mileage, performance—keep 4-wheel drive power and traction with WARN HUBS. Change 4-wheel to 2-wheel or back in seconds with fingertip control. Front end assembly stands still in 2-wheel drive—ends drag, stops shimmy, cuts front tire wear, increases gas mileage to 6 m.p.g. For Willys \$60.00, Dodge \$74.00 pr.; also Standard Hub for Willys \$20.00, Dodge \$23.00, Land Rover \$24.00 pr.; Automatic Hub for Willys \$120.00 pr., all ppd. Money back guarantee. Dealers or direct. Write for folder.

WARN MFG. CO., RIVERTON Box 6064-A3, Seattle 88, Wash.

FACTORY PRICES—10-DAY MONEY BACK GUARANTEE

NYLON AUTO COVERS

New rubberized DuPont nylon—mildew & water repellent. One side soft fabric not to scratch. Absolutely lightest and strongest cover made. Will protect against all elements. Secured with heavy elastic.



ALSO AVAILABLE
Canvas Auto Cover—Soft 6 oz., suntan, water, fire & mildew repellent. 14 lbs. . . . \$12.95 + \$1.00 ship. Extra heavy plastic cover . . . \$7.95 + 85¢ ship.

Give 8 lbs. Car Standard Model Size \$17.95 plus 25¢ ship.

DROP CLOTHS New canvas, suntan, treated wt. 6.5 oz. per sq. yd. Water, fire, mildew resistant.
FINISHED SIZES: 10x12 \$4.95 + 45¢ ship. 10x15 \$5.95 + 70¢ ship.

BOAT COVERS, 10 oz. canvas, shaped, grommetted. 6x10 \$10.95; 6x17 \$11.95 + \$1.00 ship.

NYLON TARPULINS Incredibly strong new Neoprene rubber coated DuPont nylon. Wt. 8 oz. sq. yd. Water & mildew treated. Hemmed, brass grommets, green. Made to your size. (All sizes 9' x 9'. . . . 11¢ sq. ft.)
STOCK SIZES: 7x6 \$4.25; 7x9 \$6.80; 9x9 \$8.25; 9x12 \$12.95; 9x15 \$13.95; 9x20 \$18.95; 12x12 \$14.95; 12x20 \$24.95

DEFENDER TEXTILE CORP. 425 B'WAY, DEPT. PM-10, NEW YORK 13, N. Y.

AMAZING NEW POCKET SIZE RADIO

Really Works—Small as a Pack of Cigarettes!
FITS IN ANY POCKET OR PURSE—GETS LOCAL RADIO STATIONS WITH CLEAR BELL-LIKE TONE—NO STATIC OR INTERFERENCE! NEEDS NO TUBES, BATTERIES OR COMPLICATED HOOKUPS! NO AC PLUG INS! Nothing to wear out. Thousands of users—many report years of service. Uses new crystal diode and H-G coil. SELF-CONTAINED SPEAKER PHONE. Just the tiny radio to take with you ANYWHERE YOU GO—ON TRIPS, VISITING, ETC.—for real fun and enjoyment—ANYTIME. **SEND ONLY \$1.00** (bill, ck., mo.) and pay postman \$3.99 C.O.D. postage or send \$4.99 for p.p. delivery. COMPLETE READY TO LISTEN. **MIDWAY CO., Dept. PPM-10, Kearney, Nebr.**

Secrets of VENTRILOQUISM Now Revealed!

Easy to learn in 60 to 90 days with our Home Study Course. **RESULTS GUARANTEED.** Make Money! Be Popular! Have Fun! Big Opportunity! Radio, Television, Stage Appearances! For FREE! Information regarding price and terms. WRITE. You must state your age, Denny's Catalog 25¢.
FRED MAHER SCHOOL OF VENTRILOQUISM Box 36, Studio PM-10 Kensington Station Detroit 24, Michigan

FREE CATALOG AMERICA'S GREATEST VALUES
WATCHES JEWELRY GIFTS 40% to 60% OFF
MARYLAND DISTRIBUTORS, Dept. 657
501 E. Baltimore St. Balto. 2, Md.

DRAW The First Day! NO LESSONS! NO TALENT!

New Amazing Invention—"Magic Art Reproducer." You can draw Your Family, Friends, Anything From REAL LIFE—Like An Artist! Even if You CAN'T DRAW A Straight Line! Anything you want to draw is automatically seen on any sheet of paper thru the "Magic Art Reproducer." Then easily follow the lines of the "picture image" with a pencil for an original "professional looking" drawing. Also reduces or enlarges. **SEND NO MONEY!** Free Trial! Pay Postman on delivery \$1.98 plus postage. Or send only \$1.98 with order and we pay postage. Money Back Guarantee.
NORTON PRODUCTS, Dept. 5810-S, 296 Broadway, N. Y.

NEW FALSE PLATE FROM YOUR OLD ONE IN 18 HOURS

AS LOW AS \$14.95
Send us your old broken, cracked or loose plates and we'll transform them into new lightweight wender plastic plates. NO IMPRESSIONS needed with our revolutionary method. We use your own old plates. We remake them completely in only 18 hours. Missing teeth carefully matched and replaced. We GUARANTEE TO SATISFY YOU OR REFUND YOUR MONEY.
SEND NO MONEY—Send us your name today and we'll RUSH COMPLETE DETAILS. Begin to enjoy life right now. Clip this Ad: save it and send for free facts.
CHICAGO DENTAL PLATE LABORATORY • Dept. PH10-54
30 N. Dearborn St. • Suite 807 • Chicago 2, Ill.



NOW! 55 NEW MODELS FOR 1955
World's most complete line—All types—All sizes—Plywood and new Plastic-Combo Kits—Best designs—Lowest prices! Get the facts: SEND 50¢ for BIG 1955 CATALOG of Kits plus boat hardware, paints, accessories, trailers and Armor-Glass. SPECIAL OFFER: Send \$1.00 for Catalog plus valuable book "Boat Selection-Operation-Maintenance." DEALERS INQUIRE!

Modern BOAT PLANS

With FULL-SIZE PAPER PATTERNS EASIER TO BUILD, SAVES TIME, MONEY
Over 150 modern plans and patterns with material lists and building procedure. Racing classes, cruisers, inboards, outboards, sailboats, 6 to 36 ft. All materials, fittings, etc. available at "Package" prices. Big savings! Design Catalog tells all!
SEND 50¢ for 1955 DESIGN CATALOG
Design Catalog PLUS boat building handbook, \$1.00

ARMOR-GLASS CUSTOM-CRAFT'S NEW SUPER-XXX FIBERGLAS

Permanently leakproof your boat! End annual painting and calking forever. Easy to apply to any boat. Indestructible! Hundreds of other uses.
SEND 10¢ for detailed folder and "How-to-Measure Form." Send \$1.00 for folder and measuring form PLUS two valuable booklets: "How-to-Use Armor-Glass" and "How-to-Build your own Fiberglass Boat or Auto Body." Dozens of other ideas!
PATCH and REPAIR KIT: \$5
Includes generous supply of Fiberglass cloth, Super-XXX Resin PLUS plans for making Fiberglass tool or tackle box. Dozens of uses: Repairing, patching, etc. DEALER INQUIRIES INVITED.

CUSTOM-CRAFT • DEPT. 7 • BUFFALO 7, N. Y.



TRAINED TELEVISION & ELECTRONIC MEN DESPERATELY NEEDED!

BIG PAY — SECURE FUTURE
Why work for low pay jobs or risk being out of a job. The TELEVISION and ELECTRONIC industry is BOOMING and NEEDS MEN NOW! Why waste valuable time poring over books, graphs and charts? We train you in just a few short months, to get in on the ground floor of this Billion dollar industry. You learn immediately by rebuilding, repairing and operating the most recently developed equipment under the guidance of outstanding experienced instructors.
If you want to really learn television and electronics . . . If you really want to get into the big money fast in this gigantic industry . . . it will pay you to find out the outstanding advantages of World Famous Bailey School Training. For big pay, act to-day! Mail coupon now for informative school Brochure—it contains complete information and illustrations of equipment and shop training . . . How we help you find part time jobs while in school . . . full time jobs after graduation . . . Success stories of Bailey Students.

BAILEY Technical SCHOOLS
Veteran Approved
1634 S. Grand St. Louis 4, Mo. T
NAME.....AGE.....
STREET.....
TOWN.....ZONE.....STATE....

Take perfect pictures!

USE THE NEW



Instant reading!

No computing needed!

Correct camera settings at-a-glance for all color or black & white photography!

New color styling! In handsome "Sportsman-Gray" with bright metal trim and smart black and red accents. A full size meter, weighs only 4 oz.

Complete with neck cord in "jewel-clear" Gift Box...
\$17.50
Ever-ready Case... \$1.95

New, full size photoelectric exposure meter eliminates tricky computations and guesswork. Has changeable ASA Index Slides that correspond to all popular films—black & white, color, indoor, outdoor. By merely inserting proper slide in meter you read correct camera settings in 1/stops from 1/2.8 to 1/22 and speeds from 1/25 to 1/200. Covers entire color film range in 1/3 stops and has special marks for movie settings.



Complete computer dial on back—for special films and light conditions other than normal. Calculates speeds from 1/1000 to full 16 seconds; 1/stops from 1/1 to 1/64; ASA Indexes from .3 to 800.

AT LEADING PHOTO DEALERS EVERYWHERE

SKAN a product of **G-M LABORATORIES INC.**
4250 N. KNOX AVE., CHICAGO 41

BUILD IT FIX IT with **AMBROID**

- Ready-to-use
- Fast drying
- High tensile strength
- Transparent
- Waterproof

IT STAYS STUCK!

Dries entirely by evaporation of the solvent. Quick setting—no distortion. Ideal for assembling, repairing, home crafts, electrical work, factory, workshop or household use. Send postcard for free literature.

THE UNIVERSAL **Liquid CEMENT**

EIE Try Ambroid in your business, too. For over 40 years recognized as the leading industrial adhesive of its type.

Art galleries, museums, and leading industrial concerns, rely on **AMBROID**

TRY A TUBE TODAY—At most hardware stores and hobby shops. If your dealer cannot supply you, send 30c for big 2 oz. tube, postpaid. Money back guarantee.

AMBROID WEYMOUTH 88, MASS.

ELECTRIFY your SEWING MACHINE

NEW LOW PRICE! **\$9.95** 1 YEAR GUARANTEE

Buy direct from manufacturer and save! Kit comes fully wired, installed in a jiffy. Fits all machines! You get **ALL-NEW PARTS**

- Motor & Bracket
- AC-DC 115v 60c
- Multi-speed foot control
- Cord set & block
- Easy instructions
- Steel pulley & belt

FREE . . . req. \$2.95 chrome **SEWLITE** given with every kit.

10 DAY FREE TRIAL—ORDER NOW!

Send no money, pay COD or send money order and we'll pay postage. Please state whether wheel on your machine turns toward you or away from you. Shipping wt. 6 lbs.

SENIOR SEWING MACHINE CO.
Box 147 Dept. PMGO Brooklyn 6, N. Y.

ENGINEERING DEGREE IN 27 MONTHS

INDIANA TECHNICAL COLLEGE

B. S. DEGREE, Aeronautical, Chemical, Civil, Electrical, Mechanical and Radio Engineering (inc. TV and Electronics), Drafting, 1-yr. G.I. Gov't. approved. Low rate. Earns board. Large industrial center. Students from 48 states. 21 countries. Demand for graduates. Enter December. March, June, September. Write for catalog, 1610 E. Washington Boulevard, Fort Wayne 2, Indiana.

MAKE MONEY 90 WAYS IN PHOTOGRAPHY

EARN WHILE YOU LEARN AT HOME

If you are OVER 17—good pay, fascinating work await you in photography. Start earning at once as you learn to make money 90 ways with your camera. Our famous, low-cost **LEARN-BY-DOING** method and **INDIVIDUAL** guidance train you quickly at home! Write **TODAY** for **FREE** catalog. Also Resident Training, 40th Year. G.I. Approved.

NEW YORK INSTITUTE OF PHOTOGRAPHY
Dept. 49, 10 W. 33 Street New York 1, New York

Send for **FREE BOOK**

TV TUBE 'BRITENER'

Save \$7.50 by installing this Picture Tube Rejuvenator yourself in 5 minutes. Simply attach 2 plugs as directed on instructions. Absolutely no tools or wiring. Adds months to TV Tube life. Restores original picture brilliance. Guaranteed. \$3.50 postpaid. Zee Electronics Dept. A, Box 1393, Stockton, Calif.

SAMSON FIBER-GLASS BOWS
THEY DON'T BREAK
THE WHOLE FAMILY CAN USE THE SAME BOW

CATALOG - Five Bow Arrows Materials Set **HANDBOOK** - Illustrated Instructions on Making & Shooting Arrows **Table 75c**

L. E. STEMMER CO., Box 3
MANORVILLE, L.I. NEW YORK
Making Bows & Arrows for over 40 years

NOW - IT'S EASY! Solder like an Expert!

IT'S **NEW** USE "MIRACLE SOLDER PAINT"

JUST PAINT ON AND HEAT

Solder All Common Metals
FASTER • STRONGER • MORE ECONOMICAL
ONE LB. = 4 LBS. ORDINARY "WIRE" SOLDER
FREE "Soldering Technique Guide". Agents Wanted
BOW SOLDER PRODUCTS
251 FREEMAN ST. • BROOKLYN 22, N.Y.

INTRODUCTORY OFFER
\$1.00
POSTPAID GUARANTEED

PLASTICS CATALOG

POLYESTER-FIBERGLAS BOAT and CAR MATERIALS. ALL SUPPLIES • PLASTICS FACTS • HOW-TO-DO-IT • RETAIL-WHOLESALE PRICES

Let our 14 years of plastics experience help you with your plastics problems. Our new catalog lists prices, explains how to use and how to order the following plastics: Polyester and Fiberglass for permanent boat coatings and plastic car bodies; Plexiglas, clear and colored, 1/16" to 2" sheets, rods and tubes—Acrylic and Vynilite sheet, paper-thin to 1/2"-2 1/2"-dyes, cements, supplies, metal findings, books, (including the only book of its kind, "Polyester and Fiberglass" by Maurice Lannon). The catalog is ready now and it's crammed with valuable information and facts. It will be mailed first class for 15c. or air-mailed for 25c—you'll get it within a week or less. Remember, we take pride in our fast service, the high quality of our products, our specialized knowledge and our personal attention to your problems. Send for our new catalog today and let's get acquainted.

GEN-O-LITE PLASTICS COMPANY
53508 Riverton North Hollywood, California

INSURED TIRE SERVICE
POPULAR BRANDS
FREE INSURANCE POLICY given with each used tire sold. We guarantee the amount of service you pay for.
 Tube Given Free with Each Used Passenger Tire Upon Request

SPECIAL! Deduct 10% on orders for two or more used tires

YOU CAN'T LOSE!!

GOODYEAR SUBURBANITE TYPE SNOW TIRES
 New Tire Guarantee—Factory Rebuilt
BEST WEATHER TRACTION OF ALL!
 670x15 | 600x16 | 710x15 | 800x15 | 650x16 | 58.95 | 58.95 | 760x15 | 820x15 | 650x15 | **\$9.90**

Super Quality — Rugged Performance — 15 Months Insured Service

600x16	\$3.65	670x15	\$3.95	700x16	\$4.45	760x16	\$4.75
650x15	3.85	670x16	4.05	710x15	4.35	820x15	4.95
650x16	4.28	700x15	3.95	760x15	4.45	550x17	4.65

Supreme Quality — Nothing Finer — 30 Months Insured Service

600x16	\$5.25	670x15	\$5.45	700x15	\$10.45	700x20	\$12.50
600x16(6)	6.75	640x15	4.95	750x16(8)	15.95	750x20(8)	15.50
650x16	5.78	670x15	5.35	700x17	11.95	750x20(10)	17.50
650x16(6)	7.25	710x15	5.45	750x17	16.45	825x20	21.50
700x16	6.35	760x15	5.95	750x15	10.95	900x20	19.95
750x16(6)	8.48	800x15	6.38	30x8	11.25	1000x20	20.45
550x18	4.95	820x15	6.35	600x20	10.95	1100x20	21.25
550x17	4.78	550x15	5.35	650x20	11.75	1000x22	21.95
650x16	5.25	670x16	5.15	32x6(8)	11.95	1100x22	22.75
700x15	5.35	700x16(6)	10.25	32x6(10)	12.75	1100x24	25.95

Whitewalls \$1.00 extra.

MIDLAND TIRE SALES
 Speedy shipments on Mail Orders. F.O.B. Chicago. Insurance policy sent with each order. Deduct 10% on orders for 2 or more used tires. Send CHECK or MONEY ORDER.—No COD's.
 3701 S. Normal, Dept. PM-27, Chicago 9, Ill.

NEW Level-X Car Compass

• COMPASS • LEVEL GAUGE
 • ACCELERATION INDICATOR
 - all in one -

Fits any car. Compass easy to compensate. Shows grades up or down to 20 degrees (equal to 36 1/2 grade). Rugged construction. Ideal for cars, trucks, tractors. 10 day money back guarantee. Send for yours today!

LEVEL-X, INC.
 Suite M-9, 627 Salem Ave.
 Dayton 6, Ohio

Ohio Residents add 15c sales tax

ONLY \$4.95
 POSTPAID IN U.S.A.

Patents Pending
 Distributors Wanted

DELUXE DO IT YOURSELF KIT \$120 DOZER CHAIR

• Easy to assemble
 • Adjusts for dozing, reading, sleeping
 • "No Sag" Springs
 • Durable covering
 • Gray, Green, Red, Brown
 • Money Back Guar.

Complete Kit **\$39.95**

Order now. \$5 deposit. Bal. C.O.D. Or write for literature

BESTCRAFT CO. Dept. H3, Mathison Bldg., Baltimore 2, Md.

BUILD YOUR OWN AIR CONDITIONERS
 AND DEHUMIDIFIERS — For Home or Automobile
FROM JUNKED REFRIGERATORS — FOR \$15

Instruction books □ for Home—75c □ for Car—75c. Both for \$1.00

COMPLETE "Install-It-Yourself!" KIT for Auto—ONLY \$164.70

Now you can drive in cool comfort. This kit contains everything you need to install an air conditioner in your car that is equal in capacity and performance of units costing \$600 or more. Save hundreds of dollars. Send for instruction books or further information to

SEELEY PRODUCTS CO., Dept. 5110, 3716 Belmont, Chicago 18, Ill.

PLYWOOD BOAT KITS

12 FT. **\$97.00**
 14 FT. **\$129.00**
 Freight Included

Send for free folders on all models as low as \$39.00 freight included

TAFT MARINE WOODCRAFT
 Dept. PM-10, 636 39th Ave., N.E., Minneapolis 21, Minn.

NOW YOU CAN BUILD IT WITH CONCRETE BLOCKS

10 DAYS FREE TRIAL EXAMINATION!

This practical guide shows every step from how-to-plan to how-to-build with one of the most abundant and economical building materials known to man. Over a hundred pictures and cut-away diagrams show exactly what to do and what not to do. Tells how to plan, place corner block, make foundations easily, how to paint for special purposes. A picture story of everything in building any type of structure with concrete blocks, easily and inexpensively.

concrete BLOCK construction
 FOR HOME AND FARM

Here's how little this book costs you... or if you don't keep it after 10 days trial, return it and you owe nothing. **\$3.25**

Here's how to apply Mortar

CARPENTRY FOR EVERYONE

A clear explanation of modern carpentry construction including framing, roof constructions, general carpentry work, exterior and interior finish of buildings, building farms and working drawings, and farm buildings. Covers everything you need to know about lumber, tools, joints and splices, floors, stairs, partitions, rafters, etc. Gives short cuts and tricks used by the master carpenter. Easy to understand. 504 pages, 580 illustrations. **\$2.50.** Use 10 day no-cost trial coupon below.

BRICKLAYING — WIRING — PLUMBING

Bricklaying Skill and Practice shows by clear explanations and actual on-the-job illustrations, simplifies the construction of everything from fireplaces to complete buildings. **\$3.50**

Electric Wiring—New book covers job-tested methods of residential and farm wiring, code changes. Show-how for amateur, valuable reference for tradesman, estimator, contractor. **\$4.25**

How to Design and Install Plumbing—Hundreds of how-to-do-it pictures, full-sized blueprints for most every plumbing job. 349 illustrations, 422 pages **\$4.25**

OTHER YOU-CAN-DO-IT BOOKS IN COUPON BELOW

Mail this coupon today—10 days trial at no cost to you
American Technical Society, Dept. C-719
 848 East 58th Street, Chicago 37, Illinois

Please rush me the following books I'm checking below to examine at home. If I'm not convinced these books will help me save thousands of dollars by doing my own building and planning, I may return the books and owe nothing.

Examine **CONCRETE BLOCK CONSTRUCTION FOR HOME AND FARM**..... **\$3.25**
 CARPENTRY..... **\$2.50**
 at home **BRICKLAYING...Skill and Practice**... **\$3.50**
 HOW TO DESIGN AND INSTALL PLUMBING..... **\$4.25**
 at no **ELECTRIC WIRING—**
 cost. Residential and Farm..... **\$4.25**
 How to Insulate Home & Farm Bldgs... **\$3.25**
 Steel Square..... **\$2.50**

Name _____
 Address _____
 City _____ State _____

Ten day no-cost-trial. If I keep books, will remit by check or money order.
 Send C.O.D. Same return privilege—money refunded.
 I'm enclosing \$_____ now to save postage—same return privilege—money refunded.

COME CLEAN!



Cooling systems come clean in a hurry with KLEEN FLUSH, positive-acting, acid cleaner and conditioner. Get this Hollingshead product on the Service Center shown here. It identifies the stations that know how to take care of your car.



R. M. *Hollingshead* CORPORATION
Camden 2, New Jersey

MECHANICS

—EARN BIG PAY—

Industry needs skilled mechanics. GREER, leader for more than 50 years in the Trade School field, can train you quickly—You "learn by doing," using the finest equipment, under the supervision of expert technicians.

APPROVED FOR CIVILIANS OR GI'S

—CHOOSE YOUR TRADE—

- DIESEL MECHANICS 20 Weeks
- AUTOMOTIVE MECHANICS 20 Weeks
- BODY & FENDER REPAIR 16 1/2 Weeks
- GAS ARC WELDING 4 to 12 Weeks
- REFRIGERATION 13 1/2 Weeks
- AIR-CONDITIONING 8 1/2 Weeks
- MACHINIST TRADE 30 Weeks
- ADVANCED MACHINIST (includes tool & die) 32 1/2 Weeks
- PIANO TUNING & REPAIR 36 Weeks

CHOOSE YOUR ENGINEERING COURSE

- DIESEL AUTOMOTIVE ENGINEERING 2 Years
- REFRIGERATION & AIR COND. ENGINEERING 18 Months

FREE EMPLOYMENT HELP.

Start your career with Greer by checking your interest above and mail coupon for complete information at no obligation.

NAME _____ AGE _____

STREET _____

TOWN _____ ZONE _____ STATE _____

Established 1902 — Over 50,000 Graduates.

GREER SHOP TRAINING

2236 S. Michigan Ave.
Chicago 16, Illinois

WAR SURPLUS BARGAINS

WAR SURPLUS BARGAINS

\$500,000.00 INVENTORY for QUICK LIQUIDATION

Surplus items—hundreds of them for home, shop, factory, farm and outdoor use. New items, used items, reconditioned items—all at tremendous savings—all priced for quick sale.

Page After Page of Values

This big catalog shows page after page of amazing money saving values. Write for your copy today. Send 10c to cover postage, handling, etc. Write today! **SEND TODAY FOR YOUR COPY**

10c

STARK'S 212 W. Madison St.
Dept. PM-1054
CHICAGO 6, ILL.

Up to 6 MILES MORE per Gal.

Reported by Hundreds Using
MIRACLE ACTION TUR-B-LIZER

If your car, truck or tractor is a "gas hog," try this simple cure, tested millions of miles experts call best yet. Installed in minutes TUR-B-LIZER simply traps gasoline carburetor wastes. Try it 30 days. Money back guaranteed if not enthusiastically satisfied. Mail \$3 for the 6-cyl. type, \$4.50 for 8-cyl.

\$3.00 ppd

AGENTS WRITE
TUR-B-LIZER CO. 621 E. State St.
Milwaukee 2, Wis.

WHEELS WHEELS WHEELS

7" Disc Wheel 3/4" Tire 3/4" sleeve	45c ea.
8" Disc Wheel 1 1/4" Tire 1 1/4" sleeve	70c ea.
7" Disc Wheel 1" Tire 1/2" ball bearing	80c ea.
8" Disc Wheel 1 1/4" Tire 1/2" ball bearing	\$1.00 ea.
8" Disc Wheel 1.50 semi-pneum. Tire 1 1/2" B.B.	\$1.35 ea.
8" Disc Wheel 2" semi-pneum. T. 1 1/2" B.B.	\$1.50 ea.
10" Disc Wheel 1.75 semi-pneum. T. 1 1/2" B.B.	\$1.50 ea.
10" Disc Wheel 2.75 semi-pneum. Tire 5/8" B.B.	\$2.50 ea.
12" Disc Wheel 1.75 semi-pneum. T. 1 1/2" B.B.	\$1.85 ea.

Above wheel prices includes hub cap. Plus Postage, P.O.D., accepted. AXLES—Sizes 6/16 in., 5/8 in., 1/2 in.—1/4 in. to 1/2 in.—1/4 in. to 1/2 in. drilled.

UNITED WHEEL STAMPING CO.
12131 S. PEORIA STREET PM-10 CHICAGO 43, ILLINOIS

\$2.95 OR 2 FOR \$5.00!

Genuine Telephone Company Upright Telephones, tested and guaranteed with 50 ft. of wire and inter-communication instructions. Complete line of telephones, dial, magneto, etc. Write for free list. All shipments F.O.B.

TELEPHONE ENGINEERING CO.
Dept. 1084 Simpson, Pa.

STRENGTHEN
...TRAIN YOUR
VOICE

DEVELOP A HE-MAN VOICE!

Write for FREE book "How to Strengthen Your Voice for Greater Success" by Eugene Feuchtlinger. No obligation. Book will be mailed at once in plain wrapper, postpaid. Just send your name and address. State age. Write for free list. All shipments F.O.B.

PREFECT VOICE INSTITUTE, 210 S. Clinton St., Studio KW-2, Chicago 6, Ill.

STOP

RADIO & TV NOISES INSTANTLY!

NEW ELECTRONIC DESIGN

Bell-Tronic line filter eliminates noise interference caused by motor appliances, autos, oil burners, etc. Simply plug radio or TV cord into filter and filter into wall socket. Send \$1. Add 25c for P.P. & Handling. No C.O.D. Try 5 days. Money back guarantee.

TUBE WHOLESALERS CO.
Box 384, Dept. PM10, Rockville Centre, N. Y.

\$100

COMPLETE NEW

FALSE IN 24 HOURS

FROM YOUR OLD \$15.95 NOW LOW AS . . . \$1.95

New process transforms old, broken or loose plates into new lightweight plastic plates. NO IMPRESSION NEEDED. Let us help you enjoy life again. You will marvel at this revolutionary new method. Using your own old plates, we will remake them completely in only 24 hours. Missing teeth are carefully matched and replaced. Work is done on an absolute **MONEY BACK GUARANTEE**. **SEND NO MONEY**—Just push your name and address for full FREE DETAILS. If your teeth are loose, we'll tell you how to tighten them before duplication. Act now.

Tru-Grip Dental Labs., 7th Fl., 127 N. Dearborn, Dept. 59, Chicago 2, Ill.

317 DIFFERENT FOREIGN STAMPS

only 25¢



- \$9.50 value includes:
- **STALIN DEATH STAMP** — special black-bordered issue!
 - **NEW ZEALAND** — 98-year-old proof of Queen Victoria. Sold for \$5 at auction.
 - **ISRAEL** — complete sheet of first issues.

You get all 3 scarce items shown (alone worth \$7.00)—plus **LUNDY**, fantastic Puffin issue from the only private kingdom in the world; **BERLIN BEARS**, cpl. set for Russian Zone; **SPAIN**, 3 Iberia Airmails; **FRANCE**, 3 re-issues of 104-year-old rarities—plus hundreds more! Grand total of 317 different stamps—reg. \$9.50 value—for just 25¢ to introduce our Bargain Approvals. Included **FREE**, "Midget Encyclopedia of Stamps"—plus Stamp Dictionary and Identifier. Send 25¢ today. Money back guarantee. **ASK FOR LOT FO-19**

ZENITH CO., 81 Willoughby St., Brooklyn 1, N. Y.

NO TANKS USED
NEW SIMPLIFIED METHOD

ELECTROPLATE

ANY OBJECT IN HOME, SHOP, GARAGE OR STAIR
YOUR OWN WELL PAYING ELECTROPLATING BUSINESS



NOW, using **NEW** plating kit.

It's easy to electroplate any object. Complete kit and instructions on plating metal and non-metal objects, with nickel, copper, chrome, gold, etc., plus full data on obtaining all the business you desire and make **BIG MONEY** full or spare time. **ONLY \$5.95. SEND NO MONEY**—OR thing sent C.O.D. plus postage—OR send \$5.95 now and receive it postpaid. Money back in 7 days if not satisfied.

M. Z. SALES CO., Dept. PM-6, 113 W. 42 St., New York 36, N. Y.

BE YOUR OWN BOSS EARN TO \$5,000 IN 90 DAYS

Tax Experts earn \$5,000 in 90 days! Operate your own dignified HOME BUSINESS. Previous experience unnecessary! Easily understood. Shortcut, simplified **PUBLIC BOOKKEEPING** — by mail — guarantee **STEADY** immediate income—easy! Clients unlimited. Write: **AUDITAX SYSTEMS, 10675 Pico Blvd., Los Angeles 64, California.**



Powerful GIANT TELESCOPE SEES THINGS MILES AWAY!

Ready for use. Steel telescope tube 38 in. long. 30X, 50X and 100 power eyepieces giving clear erect images. Heavy 5 ft. tripod with aluminum head assembly provides rigid mount. Guaranteed to bring all distant objects 100 times nearer, 10,000 times larger. \$12.00 FOB factory. COD orders require a \$3.00 deposit.



SUFFOLK SCIENCE SERVICE
Dept. QTM-10 Mattituck, N. Y.

\$12.00 COMPLETE

LEFAX POCKET SIZE TECHNICAL DATA BOOKS \$1.25 each

Printed on loose leaf, six hole, 6 3/4"x3 3/4" bond paper, each book contains about 140 pages of technical data, presenting condensed, accurate and essential data for the student, engineer, technical worker and business man.

- | | | |
|--|---|---|
| Architecture
Home Heating
Illumination
Electrician's Data
Builder's Data
Lumber Data
Air Conditioning
General Math.
Math. Tables
Physics
Chemical Tables
Mechanics of Materials
Power Trans. Mach'y.
Thermodynamic
Tables & Charts | Phys. & Thermodyn.
Data
Phys. & Org.
Chemistry
Metals
General
Chemistry
Reinforced Concrete
Building Constr.
Radio
Television & FM
Electricity, AC
Electricity, DC
AC Motors and
Generators | Transformers,
Relays, Meters
Hydraulics
Surveying
Mechanical Drawing
Machine Design
Machinists' Data
Piping Data
Surveying Tables
Trig-Log Tables
Metallurgy
Analytic
Chemistry
Highway
Engineering |
|--|---|---|

Write for **FREE** catalogs (over 2000 listings). See for yourself how helpful LEFAX can be to you. Send \$1.25 for each book (or \$6 for any five books listed above).

LEFAX Dept. PM-6 PHILADELPHIA 7, PA.

High quality, repeating SHOTGUNS with CHANGEABLE CHOKES



"3 GUNS IN ONE"
Model 185D
20 ga. \$25⁹⁵
(\$26.95 W. of Rockies)

"2 GUNS IN ONE"
Model 183D
410 ga. \$24⁹⁵
(\$25.75 W. of Rockies)

YOUR DEALER INVITES YOU TO LOOK THEM OVER

Two of the most amazing "buys" in firearms today! 3-shot, bolt action, hard shooting repeaters with flawless actions—and chokes quickly changeable even in the field.

YOUR FRIEND, THE GAME WARDEN

The game laws conserve wild life in order to preserve for you the sport you love. Cooperate with your friend, the game warden.

Model #185D with Full, Modified and Improved Cylinder chokes.

Model #183D with Full and Modified chokes.

With these great guns you can have—in a matter of seconds — just the choke you want. And compare those prices!



O. F. Mossberg & Sons, Inc.
49710 St. John St., New Haven 5, Conn.

FREE catalog on request
Sorry, no sales at factory

Prints Postal Cards!

FREE Use on 30 Day Trial! Send name today for facts and **FREE** Illustrated Book of unique advertising plans and money-making ideas for your business. Learn how others are boosting sales with post card ads... easy with Cardmaster.



Cardmaster Co., 1920 Sunnyside, Dept. 13410 Chicago 40, Ill.

START TO DRAW ON TRIAL PLAN



SEE HOW EASY IT IS Step by Step!

ENJOY ART FOR \$ AND FUN
Draw and paint, under professional guidance, in your home; hobby can lead to extra income, or a new career. Many earn while learning. Low tuition, easy terms, our 40th successful year. Send coupon for free book, "Art for Pleasure & Profit." Ask about Trial Plan.

WASHINGTON SCHOOL OF ART
Studio 1210N, Washington 5, D. C.

Name _____
Street _____ Age _____
City _____ Zone _____ State _____

MAIL ORDER BUSINESS

Your Big Opportunity!

24-lesson course on proved, tested, up-to-date profitable methods. Amazing treasure-trove of the best mail order plans and possibilities. Start your mail order business on a small or big scale... how to keep a growing order and your profitable monthly sales reports. Many more! Full price only \$6.35, Satisfaction guaranteed or refund. Circle below No. 40 for Mail Order Course.

ART SCHOOL Self-Taught

No previous Art training necessary. Three excellent lessons guide you step-by-step. You train yourself for a fine career in Art by following these logical, easy-to-understand instructions. More than 200 illustrations included! Lessons cover industrial design, fashion drawing, painting, lettering, symmetrical packaging, photography, etc. Entirely PRACTICAL and commercial! **Order "Art School Self-Taught," No. 1** in coupon at bottom of page. Rush order today.

How to Run a RESTAURANT...

Get into a Good MONEY-MAKING BUSINESS of Your Own!
 Virtually a complete self-instruction course on starting and operating profitable restaurants, delicatessens, coffee shops, luncheonettes, etc. Teaches you the all-important facts about layout, fixtures, equipment, furnishings, decorations, kitchen arrangement, menu-planning, etc. How to make money!
Full Price, Only \$4.95, Postpaid This could be your BIG chance! Satisfaction guaranteed or money back. Order "How to Run a Restaurant," No. 2 in coupon below.

PUBLIC SPEAKING FOR SUCCESS

HOW TO HANDLE PEOPLE
 Oration and public speaking is an art which must be learned. Don't you believe think about it! Learn to speak! For your greatest personal advancement let this excellent course teach you the fundamentals of influencing people: how to make them laugh, cry and ACT! Only \$3.95. Circle No. 3 in coupon below. Satisfaction or refund.

5 ACRES and INDEPENDENCE

How to Buy a Small Farm and Run it Profitably!
 ACCUMULATE as you learn when you own a few acres and use them wisely. You supply your own food requirements and possibly enough extra to enjoy a comfortable cash income. Make your own decisions about livestock, poultry, orchards, etc. Only \$2.95. Order "Farming," No. 4 in coupon.

WATCH and CLOCK REPAIRING

Learn at home or in the shop. This course covers all the fundamentals of watch and clock repairing. Contains a working list of parts for everything! Order "Watch and Clock Repairing," No. 5 in coupon. Satisfaction or refund guaranteed.

LOCKSMITHING & Key Making

PRACTICAL UP-TO-DATE COURSE! Only \$4.95 complete. Teaches you the professional "secrets." How to lock, de-code, make masterkeys, install and set in key systems, etc. Step-by-step detailed, illustrated instructions make every operation crystal clear. Money-making information for repairmen, mechanics, hardware dealers, grocers, etc. Includes a working list of parts! 30 lessons! Satisfaction guaranteed or refund! Order "Locksmithing Course," No. 6 in coupon. Only \$4.95, Mail coupon today!

PIANO TUNING

Experienced piano tuners charge up to \$10.00 for a job they finish in about an hour. Reason? Because they have had two years' training for this profitable field! Right now, it is NOT necessary that you also spend two years... now don't you have to invest two years in it!
SELF INSTRUCTION COURSE - only \$4.95 complete price. This is excellent home-study course includes instructions on piano regulation, repairing - with every service explained and every good piano tuner knows. Also covers electric organs, tuning by Stimp, harp, etc. Good, clear, helpful illustrations to guide you step-by-step. Money-Back Guarantee. Order "Piano Tuning Course," Only \$4.95. No. 7 in coupon.

HOW TO BUY, SELL, TRADE OLD GOLD, ETC.

A new 36-page pocket Technical Handbook to teach you how to make money dealing in precious metals - broken jewelry, old gold, silver, platinum, etc. Knowledge opportunities for those with experience. Only \$3.00. Order "Old Gold," No. 20 in coupon below.

Awaken Your Hidden Powers! MENTAL SCIENCE

YOU are a sleeping giant... how to release your unused forces. Teaches you self-mastery, influencing others, getting ahead, etc. Written by 14 renowned investigators. COMPLETE. ONLY \$4.95. Low price! Order "Mental Science," No. 19 in coupon.

HOW TO GET A GOOD JOB

Shows you step-by-step the successful technique of securing yourself a better position in any field. Teaches you how to sell yourself in a job interview. A Practical 26-lesson course. Full price only \$4.95. Satisfaction guaranteed or refund. Order "Getting a Good Job," No. 43 in coupon below.

Learn UPHOLSTERING

Start by doing work on your own furniture to get money & beauty for your home. Then branch out as you gain experience. You'll learn quickly and enjoy. These step-by-step instructions on how to create, repair and rebuild practically all kinds of upholstered furniture. You get everything for only \$4.95, complete. Satisfaction or money back. Order "Upholstering," No. 9 in coupon.

CRIME DETECTION

This good new 26-lesson course will help you look for clues that include valuable examination systems and standards. These lessons are arranged for men who wish to qualify for professional work in law enforcement. Also of interest to detectives and investigators, officers, coroners and state law enforcement officials. This valuable information may be used to great advantage by lawyers, detective agencies, etc. Complete, only \$3.95, satisfaction guaranteed. Order "Criminal Investigation," No. 10 in coupon below.

MASTER MIND!

Learn Short-Cut Mathematics
 New formulas, do nothing number tricks. Make percentages of your memories lightning-quick work. Multiply figures by 9 figures without using old-fashioned multiplication. No rote learning! Complete, only \$3.95, satisfaction guaranteed. Order "Master Mind," No. 11 in coupon below.

Sharpen Up Your Brain Power

Practical plan for retiring young and fully enjoying life... health and vigor. Tells you how to adjust yourself and make a little money go a long way with wisdom. Only \$2.95. Order "Retirement," No. 12 in coupon.

RETIRE AND BE HAPPY

A practical plan for retiring young and fully enjoying life... health and vigor. Tells you how to adjust yourself and make a little money go a long way with wisdom. Only \$2.95. Order "Retirement," No. 12 in coupon.

POULTRY RAISING

Practical, workable instructions on how to start a chicken flock in your back yard or on a small farm. Shows you how to raise poultry efficiently, pleasantly - and profitably! Contains every detail of poultry raising, step-by-step instructions on raising chickens, ducks, turkeys, etc. No. 13 in coupon. Satisfaction or refund!

practical RADIO servicing

Self-instruction course in one large volume - ONLY \$2.95 COMPLETE! Teaches you the practical side of radio repair, adjustment, operation, trouble-shooting. No previous knowledge necessary. Includes a working list of parts. Includes the mathematics, questions & answers. Order "Practical Radio," No. 14 in coupon. Satisfaction guaranteed. Full price, only \$2.95.

SWEDISH BODY MASSAGE

Course of instruction in the Art of Body Massage and reflexology. Includes information on fundamentals of anatomy, physiology, procedure for complete massage, approved exercises, etc. Includes an appendix. This valuable study may open door to a lucrative career in the profession. Only \$7.95, No. 15 in coupon. Satisfaction guaranteed.

Complete PRACTICAL BLUEPRINT READING COURSE

Interesting, simple and profitable! Includes: mechanical, electrical, etc. 24 lessons, including you get actual blueprints, glasses and step-by-step drawings. FULL PRICE ONLY \$3.95. Unusual bargain! Satisfaction or refund guaranteed. Order "Blueprint Reading Course," No. 16 in coupon below.

BUILD IT YOURSELF

Be a general handyman! Save time and money on any job. Carpentry now made easy. New self-instruction course in one handy volume, complete with full-page photographs, etc. Teaches practical woodworking, joinery & gluing, upholstering, power tools, cabinet making, etc. Full COMPLETE PRICE ONLY \$2.49. Order "Build It Yourself," No. 17 below.

JEWELERS & WATCHMAKERS Cyclopedia

Packed with trade secrets, manufacturing processes, little-known formulas, etc., for opticians, stone setters, engravers, case makers, jewelers, photographers and others. 1901 money-making ideas for the practical man! Only \$3.95. Order "Jewelers Cyclopedia," No. 18.

REAL ESTATE BUSINESS!

Money-making information. Includes instructions in appraisals, valuations, management, investment, practical real estate operating, low-cost housing, the law on real estate transactions including legal forms, etc., salesmanship, and many other subjects a successful real estate man must know. Strictly up-to-date. Complete. ONLY \$6.95. Order "Real Estate Course," No. 31 in the coupon below.

APARTMENT HOUSE MANAGEMENT

Wonderful field for ambitious men and women, especially if you own one. Experienced managers have a steady work, good pay and SECURITY or money back guaranteed. Complete, only \$4.95. Course No. 8 in coupon below.

Cure SELF-CONSCIOUSNESS

Show to develop a strong, positive personality - get rid of timidity, bashfulness, shyness and fear, uncertainty of self, lack of confidence. Based on new principles of practical psychology. Monthly self-confidence now for your complete course of 22 lessons! Includes 100 illustrations. **ADT A Book!** Full price only \$4.95, postpaid, or C.O.D. price only \$4.95. Satisfaction guaranteed or refund. Order "Curing Self-Consciousness Course," No. 15 in coupon at bottom of page.

BUSINESS LAW

Shows you how to avoid trouble and get the most out of your business. Valuable legal information for additional, word you want to be sure you are protected in business. The best MILLIONS in profit practical use TODAY! In 40 lessons includes complete course on how to avoid to many important principles and fundamentals of the law that you should understand. Only \$4.95. Order "Business Law," No. 34 below.

Practical Business Arithmetic

When time is money this useful course should pay for itself many times over. Teaches you how to handle your every-day business calculations with accuracy and quickly. Here are the best ways of figuring percentages, profit, loss, profit, discounts, etc. Includes 100 illustrations. **ADT A Book!** Full price only \$4.95, postpaid, or C.O.D. price only \$4.95. Satisfaction guaranteed or refund. Order "Practical Business Arithmetic," No. 35 in the coupon below.

Learn YOGI!

Practical Course - ONLY \$4.95 Complete includes 100 illustrations. Teaches you self-control. Helps your personal efficiency. Points out time-tested methods for a happier, more successful life... includes 100 illustrations. **ADT A Book!** Full price only \$4.95, postpaid, or C.O.D. price only \$4.95. Satisfaction guaranteed or refund. Order "Learn Yogi," No. 36 in coupon below.

Make the Most of What You've Got!

How to develop Your Memory And Put It To Practical Use
 This course will teach you the secrets to do CLEAR, ORDERED thinking, speaking and working. Note "trick system" but vitally a self-instruction course in concentration and straight thinking. Learn how successful people retain and use their information. Knowledge and facts. This information is worth its weight in gold. Full price only \$3.95. Order "Memory Course," No. 23 in coupon.

FORGETTING!

How to develop Your Memory And Put It To Practical Use
 This course will teach you the secrets to do CLEAR, ORDERED thinking, speaking and working. Note "trick system" but vitally a self-instruction course in concentration and straight thinking. Learn how successful people retain and use their information. Knowledge and facts. This information is worth its weight in gold. Full price only \$3.95. Order "Memory Course," No. 23 in coupon.

How to Use BETTER ENGLISH

in Your Letters and Conversation
 This course will teach you the secrets to do CLEAR, ORDERED thinking, speaking and working. Note "trick system" but vitally a self-instruction course in concentration and straight thinking. Learn how successful people retain and use their information. Knowledge and facts. This information is worth its weight in gold. Full price only \$3.95. Order "Memory Course," No. 23 in coupon.

SHOE REPAIRING COURSE

New, well-illustrated series of lessons on how to rebuild shoes. Written for the beginner who wants to go into business or the family man who wants to save money on shoe repairs. Full price only \$4.95. Satisfaction guaranteed. Order "Shoe Repairing Course," No. 44 in the coupon below.

How to Write Songs

A PRACTICAL COURSE IN LYRICS - MUSIC - SELLING
 Best selling hit songs of today are written by those who know only the special "techniques" or secrets. You don't have to spend long dreary years studying theoretical music in order to do popular songs the public goes wild over. If you have the stuff inside of you to begin with... this practical course will teach you how to get it down on paper and will teach you exactly how and where to sell it for sale. ONLY \$3.95. Satisfaction or refund guaranteed. Order "Song Writing," No. 38 in coupon.

How to Get Along in This World

Boiled down, practical tips on Success! Here, gathered together for the first time, are 8,000 pearls of worldly wisdom on how to live joyously, successfully... how to handle people, make money, deal with men, and do many other things. ONLY \$3.95. Order "How to Get Along in This World," No. 33.

EUGENE FEUCHTINGER'S HINTS ON VOICE DEVELOPMENT

Basic exercises designed to strengthen your vocal organs and improve your voice. These new self-instruction course will teach you how to get it down on paper and will teach you exactly how and where to sell it for sale. ONLY \$3.95. Satisfaction or refund guaranteed. Order "Song Writing," No. 38 in coupon.

HOW TO SING FOR MONEY!

Teaches you the art and business of singing popular songs professionally. Practical course written by ASCAP member Charles Henderson, one of Hollywood's top-fight vocal coaches who has worked with Bing Crosby, Dinah Shore, Frances Langford, Kenny Baker, etc. These short-cut to success teach you how to make the most of what you've got! Full price, ONLY \$3.95. Order "How to Sing for Money," No. 29 in coupon below.

2,000 MONEY- SAVING FORMULAS

Chemical and trade information - up-to-date & reliable - on cosmetics, paints, cleaning compounds, insecticides, fertilizers, oils, lubricants, beverages, drugs, etc., etc. Only \$3.95 complete. Satisfaction or refund. Order "2000 Money-Saving Formulas," No. 48 below.

IT'S EASY TO ORDER

In coupon draw a circle around the number of each course you want us to send you. Print your name and full address clearly, then mail coupon right away. Send full payment with your order and we'll prepare all postage charges - on C.O.D. shipments you pay charges. Satisfaction or refund guaranteed... you take no risk.

FREE!! Select two or more courses from this page and we will include an EXTRA educational item as a special bonus... without any additional cost to you! You may keep this excellent Dividend Item, as your own, even should you send back for refund the courses you order. We reserve the right to withdraw this unusual offer when present limited stock is gone. Don't lose out - mail coupon today!

NELSON - HALL CO., (Established 1909!)
 210 S. Clinton St., Dept. KW-2, Chicago 6, Ill.

Mail This No-Risk Coupon Today

NELSON-HALL COMPANY, Dept. KW-2
 210 South Clinton Street, Chicago 6, Ill.

Please rush me the practical concentrated courses I have circled below. I understand each is complete and that this is the full price, nothing more for me to pay. I have the right to examine everything you send me for 10 full days. Then if I am not more than satisfied in every way I will return the material and you guarantee to make complete immediate refund, without question or quibble. (Draw a circle around the number of each course you want.)

1 2 3 4 5 6 7 8 9 10 11 12 13 14 15 16
 17 18 19 20 21 22 23 24 25 26 27 28 29 30 31 32
 33 34 35 36 37 38 39 40 41 42 43 44 45 46 47 48

I enclose \$_____ in full payment. Ship entirely postpaid.
 Ship C.O.D. for \$_____ plus postage.

NAME _____
 ADDRESS _____
 CITY _____ STATE _____

Paint STRIPES with New "PAINT PEN"!

Makes Straight, Curved or Parallel Lines!

Just fill glass vial with any color paint. Use like a fountain pen to stripe furniture, bikes, autos, model planes, toys, linoleum, wall board. Beautiful, clean, crisp results every time, like professional painters. No experience needed to draw straight, curved, circular or evenly spaced parallel lines. Can't clog or smear. May also be used with glue, tempera, textile paint, or ceramic underglazes. Paints on wood, glass, plastics, metal, fabrics and paper. Lasts a lifetime. Only \$1 postpaid, complete with tip for 1/16 inch stripe. C.O.D.'s plus postage. Used by industry. Order your Paint Stripping Tool TODAY!

New! "DOUBLE-STRIPE" MODEL Only \$2.95

Newest paint stripping invention. Makes DOUBLE stripes—one wide and one narrow or two wide or two narrow at the same time. Gradapt quickly for wide or narrow single stripes. Makes 5 combinations. FREE—Send postcard for complete information... or order now... \$2.95.



\$1.00

DEALERS

Master Paint Stripping Tool packed in Display Cartons of 1 dozen. Fast, profitable seller. Write for discounts.

Attention All Home Craftsmen!

New Paint Stripping Tool gives "professional" results every time, yet simple, easy to use. Send \$1 now.

ATTENTION—MANUFACTURERS!

Write today for information about our industrial and production stripping tools.

WENDELL MFG. CO., Dept. 3-L
4234 Lincoln Ave., Chicago 18, Illinois

6 Other Complete Tools

Complete tools for 1/64, 1/32, 3/64, 5/64, 3/32 or 1/8 inch stripes, \$1.50 each. Extra tips 75c ea. COMPLETE KIT with ALL 7 TIPS, \$5.00. (Also 1/4" tip, only \$1.00). All tips interchangeable.

STOP BURNING OIL!

U-KAN-DU

a professional ring and valve grind job! '37-'53 Chev.

Save up to 90% on engine overhauls with guaranteed ring, gasket, and valve grind kit. Simple U-KAN-DU instructions. Order by make, model and size. Free info. Cash orders prepaid, 1/2 down on C.O.D.

POSTAL PARTS P. O. Box 1431, Marysville, Calif.

SAVE \$65 ON THIS \$100 CONTOUR CHAIR

- Goodyear Air Foam Cushioning
- Duran Upholstery
- Easy to assemble—hammer, screw-driver only.
- Green, Gray, Red, Brown
- Money back Guarantee

Everything needed to put together in one evening. Complete Kit Only \$34.95

ORDER NOW. \$5 deposit. Balance C.O.D. Or write for literature. RESTECRAFT CO., Dept. 82, Mathieson Bldg., Baltimore 2, Md.



FREE 164 PAGE 1955 B-A CATALOG

Complete guide to Everything in Radio, TV and Electronics for Dealers, Servicemen, Schools, Amateurs, Broadcasters, Public Utilities, Engineers, Experimenters, Factories and Laboratories.

BURSTEIN-APPLEBEE CO., 1012 McGEE ST., KANSAS CITY, MO.

BIG SAVINGS ON FAMILY SAFE TIRES!

PARTIALLY USED—NOT RECAPS! FREE This Pictured Tire Ash Tray With Your Name With 2 or More Tires! If you buy 2 or 3 car tires GET AN EXTRA TIRE FREE! FREE RUBBER TUBE given with every tire!

GOODYEAR, GOODRICH, FIRESTONE, U. S. and others

Factory adjusted tires, change offs—one grade only!

FINEST PREMIUM GRADE—34 MONTHS WRITTEN GUAR. BOND			
600-16	\$4.57	650-15	\$4.67
650-16	5.07	700-15	4.77
700-16	5.47	800-15	5.27
640-15	4.37	820-15	5.47
670-15	4.57	850-17	3.97
710-15	4.57	825-18	3.97
760-15	4.87	750-16FK	4.77
		750-17	7.97
		750-17	10.37
		1000-20	58.87
		700-20	9.77
		750-20	10.27
		825-20	16.87
		900-20	15.87
		1000-20	15.97
		1100-20	17.87
		1000-22	16.87

PASS. SNOW-TRED FACTORY RETREADS GUAR. 24 MOS. \$7 Recap with Grade CAR A Cold Rubber.

MARVIN 6th & Spring Garden Sts. MILITARY MUD-GRIP TIRES
BLATT Philadelphia, Pa. AA Guar. 20 Mos. AAA 34 Months
"22 YEARS OF SINCERITY" 900-16 \$10.27 900-16 \$13.97
750-20 9.27 750-20 12.57

Send Check or M.O. & this Ad to save C.O.D. COLL. CHARGES We Cater to School Busses, Churches & Hospitals the World Over

STOP FUMIN' WITH LEAKY, NOISY TOILETS! INSTALL

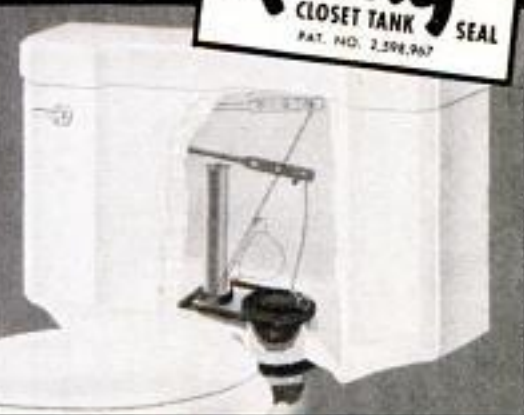

No guide arm or wires to corrode or misalign—no more leaks, gurgles, trip-lever jiggling or wasted water! Full flush, perfect seal, always. Easy to install and operate. Five-year Unconditional Guarantee. If your plumber or hardware dealer can't supply you, send \$1.50 for sample.

LAVELLE RUBBER CO.
1811 W. Hubbard • Chicago 22, Illinois

PREPARE FOR THE BEST JOBS IN INDUSTRY

- MECH. ENGINEER
- DRAFTSMAN
- TOOL DESIGNER
- TOOL ENGINEER
- TOOL & DIE MAKER
- MASTER MACHINIST

TRAIN at HOME IN YOUR SPARE TIME or at ALLIED INSTITUTE in Chicago

NO RECESSION FOR ALLIED TRAINED MEN
MORE JOBS THAN GRADUATES Shortages of Draftsmen, Designers, Tool Engineers, Machinists, Tool & Die Makers are so widespread that you can pick a highly paid key job and look forward to Achievement and Security.

You can begin your training in Short Courses and continue progressively to a Bachelor Degree in 26 months.

Allied is approved by Industry, Dept. of Education, Office of Public Instruction, State of Illinois, U. S. Veterans Admin., U. S. Dept. of Justice, Accredited: C. S. A.



ALLIED SCHOOL of MECHANICAL TRADES

1338-42 South Michigan Ave. Dept. PM-10 Chicago 5, Illinois

SEND ME WITHOUT OBLIGATION INFO. ON YOUR COURSES:

HOME STUDY RESIDENT VETERAN NON VETERAN

NAME _____

ADDRESS _____ AGE _____

CITY _____ STATE _____



Whatever your hobby

Model building, whittling, Indiancrafts, leather, plastics or any other creative handicraft

x-acto knives, tools & sets

designed by craftsmen and precision-made for fine craftsmanship

will help you do a better job

and get more fun and satisfaction from your hobby.

Whittling your hobby?

Send 25¢ for 40 page booklet with detailed instructions and plans for 34 projects.

X-acto 28 page catalog—20¢ dept. M-10



x-acto, Inc.

48-41 Van Dam Street
Long Island City 1, N. Y.

make your hands more creative with x-acto



WATCHMAKING

Why spend all your life at dull or backbreaking work? Watchmaking is light, clean, fascinating. Lifelong livelihood. Learn the quick Sweezer way at home or Chicago School. Modern methods, step-by-step. No previous experience needed. Individual training. Start any time. Approved for vets. Send for FREE sample lesson. No obligation. Write today!

CHICAGO SCHOOL OF WATCHMAKING

2330 N. Milwaukee Ave., Dept. 1104, Chicago 47, Ill. Veteran
Send me FREE sample lesson Home study Resident school

Name _____
Address _____
City _____ Zone _____ State _____

LOOK! New Gem Discovery



More Brilliant Than a Diamond And Looks Exactly Like a Diamond!

Your friends will think you are wearing the most glorious diamond they have ever seen. Yes, the Kenya is a man-made gem, a miracle of modern science. Brilliant, one carat gem, unmounted, only \$32. Also men's or ladies' superb rings, in all carat sizes. Write today or mail coupon for full story of the amazing Kenya Gem.

KENYA GEM CORPORATION
Dept. 199 Philadelphia 44, Pa.

— Send No Money! Mail this FREE Coupon —

Kenya Gem Corp., Dept. 199 Philadelphia 44, Pa. Please send me, without obligation, the FREE Booklet illustrating the Kenya Gem rings.

Name _____
Address _____
City _____ State _____

FREE! 105 British Empire STAMPS

Amazing offer! Worth over \$2 in Standard Catalog, sent FREE to make new friends. From Aden to Zanzibar—far corners of the world—including sensational new Queen Elizabeth, unusual stamps from Pitcairn, Cayman, Falkland Is. Free booklet "How to Recognize Rare Stamps"; interesting approval offers included. Send 10¢ for postage and handling. **KENMORE STAMP CO., Milford TR-418, N. H.**



FREE! 107 IRON CURTAIN STAMPS

SENT TO MAKE NEW FRIENDS!

Worth over \$2 in Standard Catalog! Sensational Stalin Stamp from Hungary plus 106 others from Russia, East Germany, Romania, etc.—hard-to-get stamps, many smuggled from behind ruthless Iron Curtain. We'll include free valuable illustrated book, "How to Recognize Rare Stamps" and other interesting special offers. Send 10¢ for postage and handling. **KENMORE STAMP CO., Dept. 0H-419, Milford, N. H.**

\$2850 BUILDS INCOME DUPLEX

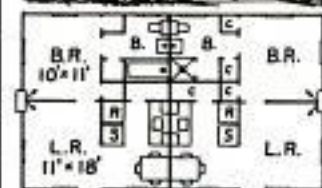

Build your own duplex from our full size plans. Choice of frame, brick veneer, or concrete block. Features include awning windows, slab and asphalt tile floors, factory cabinets, rock wool insulation and soundproofing. Each side contains livingroom, dining area, kitchenette, bedroom, bath, four closets, wall furnace and one-half ton air conditioner. You receive two sheets genuine blueprints showing floor plan, foundation, wall section, front and side views and large two dimensional cutaway drawing of entire framework, also material list and proven cost estimate (cost above for brick), \$2.95 Post. Unconditional money-back guarantee.

BAILEY BUILDERS, 915 Pyramid Bldg., Little Rock, Ark.

.22 RIFLE SALE CARBINE STYLE

Reduced from \$14.95
\$9.95

Exclusive with **UNITED**. German Precision, simplified, 4 lb. Feather-Weight rifle, 34" long. Ruger, 1 arrow takedown. Automatic ejector with self adjusting sporting rear sight, blade front sight. Highly Polished Bolt Action. Blued. Amazingly accurate. Replacement parts easily secured. Shoots American Longs, Shorts, Long Rifle (regular & hi-powered), 10 Day No Risk Trial. If dissatisfied return for refund. Add \$1 for postage & handling. C.O.D.'s require \$2 deposit. Mail Orders Only. State Age. **UNITED ARMS, 9043 S. Western, SHOB-865, Chicago 20.**

Learn CARTOONING



at home in spare time . . . the quick easy Landon Picture Chart way. Teaches how to originate—today's big need. Scores of successes. Send 10¢ for Picture Chart (to test ability) and full details. Please state age.

Landon School of Cartooning, 5410 CTS Bldg., Cleveland 14, O.

\$\$ SAVE GAS \$\$

WITH THE AMAZING NEW **ATOMIZING SCREEN GAS MISER**
Simple to install—No moving parts. Never wears out. Will save its low cost in few months. Improves engine performance.
State make and model of car. — Order today
AGENTS WANTED
CENTRAL SALES COMPANY
2701 N. 91st Street Milwaukee, Wisconsin
\$2.00 Postage Prepaid

Say You Saw It in Popular Mechanics

MUSIC IN YOUR PALM!



NEW TUBELESS POCKET SIZE RADIO
WEIGHT ONLY TWO OUNCES. BUILT-IN SPEAKER MECHANISM — NO HEADPHONES REQUIRED! NO STAYIC! Uses world's finest Signal Detector—Super-Sensitive Germanium Diode Rectifier—Developed for Radar, it performs at high level of volume and efficiency. Nothing to burn out or run down; should last for years. Gets local radio stations with amazing clearness — many users report reception up to several hundred miles. War was stop production or might take entire output for military use, so order today and be prepared in case a national emergency should arise. Over 25,000 sets already ordered and delivered. **RADIO COMPLETE** ready to play. Rush check, cash or money order. No C.O.D.'s accepted. \$7.95 ea. or 2 for \$15. **Scientific Products of Indianapolis, Inc.** Dept. PM10, 2450 E. 62nd St., Indpls. 5, Ind.

POPULAR MECHANICS

Take your Short Cut to HIGH-PAY JOBS or BE YOUR OWN BOSS IN Television

TRAIN FOR SUCCESS AS A TV TECHNICIAN IN YOUR SPARE TIME AT HOME—EARN WHILE YOU LEARN!

Are you looking for employment opportunities with a FUTURE? What are your chances for promotions or raises in your present job? BETTER YOURSELF... train NOW for profitable jobs in the booming Television Industry. Thousands of top jobs are awaiting the Trained TV Technician. HERE IS YOUR BIG OPPORTUNITY IF YOU ACT NOW!

MANY UTL TRAINEES MAKE \$25 A WEEK IN SPARE TIME, while still in training. The money and radios for neighbors... assisting service shops and distributors, more than paid for the training, and permitted them to enjoy many of the luxuries in life. UTL SHOWS YOU HOW!

NO EXPERIENCE NECESSARY YOU ARE READY TO TRAIN AS YOU ARE!

You don't have to know the first thing about electricity or television at the start, to master UTL Training. Step-by-step instructions TELL you how—thousands of pictures, diagrams and charts SHOW you how! The finest equipment GIVES you the Know-how! Age or experience is not important... just your AMBITION.

Be Your Own Boss No Money Down!

Start your own profitable service business immediately after graduation, without putting one cent down for equipment, stock, parts, and tubes. Get the amazing details! ACT NOW... OFFER LIMITED TO FIRST COME, FIRST SERVED.

NOTE TO MEN PAST 40:

If you find it difficult to get ahead, here is your opportunity to be independent and have your own thriving business.

ALL PROFESSIONAL TOOLS AND EQUIPMENT FURNISHED, COMPLETE!

UTL sends you everything you need for successful Home Training. These BIG KITS, which you keep, convert any table into a fascinating experimental laboratory. Enjoy doing hundreds of thrilling experiments and interesting demonstrations. Build professional equipment to use in your career, including a volt-ohm-milliammeter, a complete superheterodyne receiver, a cathode-ray oscilloscope and other valuable units. Practice servicing on TV receiver units!

UTL has Successfully Trained Thousands

Amazing Training Program has caused graduates to say UTL training was responsible for their getting ahead so fast... trainees report UTL training is the easiest thing they have ever done! Training is professional and efficient... you are treated as a person, on an individual basis.

TRAIN AT HOME... set your own pace. Practice with parts and equipment sent you. UTL instructors give you full assistance. Your training is remarkably EASY. Upon completion, you...

TRAIN IN UTL LAB, for 160 hours of INTENSIVE, ADVANCED TV EXPERIENCE! You operate modern equipment found only in a lab; do interesting trouble-shooting assignments; get the professional touch by knowing accepted TV circuits, equipment and standards!

JOB PLACEMENT SERVICE and BUSINESS PLAN IS AVAILABLE when you complete your training. Excellent record. Find out for yourself!

COLOR TV TRAINING INCLUDED!

Exciting, profitable COLOR TV is now a commercial REALITY! Industry leaders predict that in years to come, COLOR TV WILL PRACTICALLY REPLACE BLACK AND WHITE TV! UTL training prepares YOU to take full advantage of the HUGE field of black and white TV NOW... as well as putting you in position to EXPAND WITH THE RAPID GROWTH OF COLOR TV!

This means ADDED OPPORTUNITIES FOR YOU with UTL TRAINING. ACT NOW... get in on the ground floor of COLOR TV!

FREE FREE FREE!

Exciting big 48-page book is jam-packed with information on how to get high pay jobs in TV... how easy it is to train; how to build up prestige and income at the same time; how to take advantage of your opportunities.



UNITED TELEVISION LABORATORIES
19th & MAIN • LOUISVILLE, KENTUCKY

DON'T DELAY-MAIL THIS TODAY

UNITED TELEVISION LABORATORIES, Inc., Dept. M540
19th and Main Streets, Louisville 3, Kentucky
Send me the big, valuable 48-page book of Opportunities, FREE! I understand I am under no obligation.

Name _____
Address _____
City _____ Zone _____ State _____
Married _____ Single _____ Age _____

PLEASE SEND DETAILED INFORMATION ON:

- TV Technical Training
 Owning my own business
 Television Studio Techniques
 How to get a high-pay job in TV

Start a profitable manufacturing business in spare time

with your own home
as your headquarters

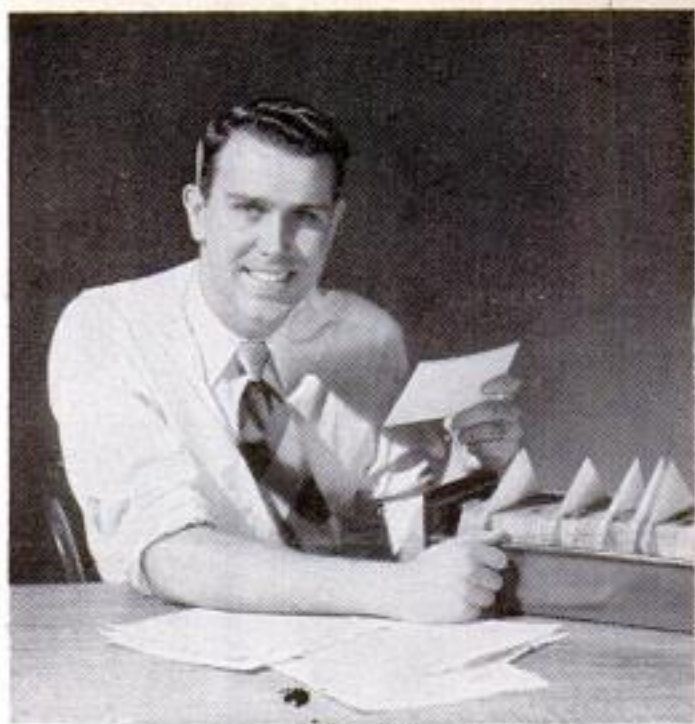

RIGHT at this moment there is a tremendous demand for new business enterprises in a branch of the plastics industry. Fortunately, this is a type of manufacturing business that does not require heavy or expensive machinery, rented space for storage, production or sales. A portable hand machine does the work wherever electric current is available, and the working area can be in almost any part of your home.

The opportunity that is open to you today, is to meet this growing demand in a new industry by establishing yourself as the manufacturing agent in your own trading area. Several hundred of our machines are already in use in both large and small communities. Some are even being operated successfully by women whose family duties make it necessary for them to be at home during the day, but whose family income is not enough to meet rising expenses. Most are being operated by men. Many started in spare time just to pick up an extra five or ten dollars for an evening's work. They found the work so profitable that some have now given up former jobs to devote full time to a business of their own.

One of our manufacturers gets all of his business by mail. Orders and money come to him in envelopes and he sends his products out the same way. Another delivers his entire output to stores in the vicinity. An-

other does a wholesale business supplying other manufacturers who do the selling. Still another works with advertisers in the manufacture of plastic advertising novelties and specialties.

The operation of the machine is simple and easy for anyone to learn. It does not require any knowledge of chemistry, mechanics, or electricity. And what some say is best of all, a manufacturing business like this enables a person to make good money without any house to house canvassing. The machine turns out from \$5.00 to \$15.00 worth of work per hour and it can be operated for as short or long a time as you wish.

We have prepared a simple step by step instruction manual that not only tells how to operate the machine, but also tells how to get the business coming in at a profitable clip right from the start. We will lend a copy of this book to any serious minded man or woman with the

understanding that a copy will be given them free if and when they purchase a machine—or the copy we lend can be returned if you decide not to go into the business. Reading it will not cost you anything.

If you are interested in a nice little home business that can bring in an extra \$60 or more for ten or twelve hours work in spare time, send your name. All information on the book and machine will be sent free, postage prepaid and no salesman will call to bother you. You read about it in the privacy of your own home without outside pressure and then decide whether you'd like to take the next step. Address your envelope to me in person. Send me the coupon below. Or, if you prefer send your name on a post card and ask for "Free information on starting a manufacturing business at home." Either way, send your name today and find out about this wonderful new fast growing money-making business.

RAYMOND E. BRANDELL

1512 Jarvis Ave., Dept. L-10-L, Chicago 26, Ill.

Raymond E. Brandell, 1512 Jarvis Ave., Dept. L-10-L, Chicago 26, Ill.

Dear Mr. Brandell: Please send information showing how I can start a profitable manufacturing business in my home in spare time. All the information you send will be mailed to me free of charge and no salesman is to call on me. I am not under any obligation to go ahead with the business and there is no charge for this information now or any other time.

Name _____

Address _____

City _____ Zone _____ State _____

POPULAR MECHANICS

**WORLD'S
BEST
WANT-AD
MEDIUM**

CLASSIFIED ADVERTISEMENTS



Advertisements in this section \$1.00 per word, each insertion, minimum 10 words, payable in advance.
To be inserted under proper classification, copy must be in our office the
20th of the second month preceding date of issue
F. W. Johnson, Manager, Classified Advertising
Popular Mechanics Magazine, 200 East Ontario Street, Chicago 11, Illinois

YOU'LL PROFIT

By reading and answering the classified ads in this section. Hundreds of opportunities for you to make and save money

AUTOMOBILES, MIDGET CARS

CROSLY Factory rebuilt engines. \$185. Glenn Walraven Motors, Marion, Ohio.

TQ Midgets, blue prints for home construction. \$2.50 c.o.d. Free literature. Wfff Mfg. Co., 2344-T Dudley, Pasadena 7, California.

WORLD'S Largest supplier hi-mileage speed equipment. Thousands of items to help double the power, mileage, speed of your car. Amazing fuel savers. Complete customizing parts. Thick photo-catalogue 25c. (Literature free.) Write today. Newhouse Automotive Stores, Los Angeles 22, California.

FREE Motor magazines; automobile literature, old, new and foreign; glossy photos, dealer books, shop manuals, offered with non-profit organization. Write today; get on free mailing list. Auto Maniacs, Stockbridge, Mich.

LOOK! Names of over 2000 American automobiles, who made them, where and when. Only \$2.00. All American Automobile Record, 1016 Sully St., Laramie, Wyo.

BUILD Midget auto. Complete drawings, pictures and list of parts \$1.00. Lee's Midget Autos, Box 82, Avila, California.

AUTO SUPPLIES AND EQUIPMENT

PROTECT Yourself and your loved ones from death or serious injury. Install ASA safety belts in your car. Shown on TV by Arthur Godfrey. \$12.95 complete, postpaid. William Wimmer, 121 Laurel Ave., Roseville Park, Newark, Del.

IMPROVED Traction, smooth riding, tire chain. Can be constructed in any home work shop. Instructions for building \$2.00. A. B. Clark, Nunn Building, Amarillo, Texas.

SENSATIONAL Free-trial offers at bargain prices! Send no money, pay postman nothing! Try these famous Gale Hall engineering automotive instruments (brand new, original cartons) at our risk for seven full days, then send payment or return merchandise! Testmaster compression tester, formerly \$10.75, only \$3.98! Dual-purpose engine analysis vacuum gauge and fuel pump tester, 5" diameter, usually \$11.70, now \$4.55! 3 1/2" diameter, was \$8.10, now \$3.98! (Free with above instruments, valuable giant wall instruction charts, originally priced \$1-\$1.50 each!) Original motor condition/gasoline economy gauge for permanent dashboard mounting, formerly \$7.50, now only \$2.98—All instructions and accessories free! Famous Mile-O-Meters, standard model, 2 3/8" diameter, slashed from \$9.75 to \$4.55! (Illuminated \$4.98!) Deluxe model 3 1/2" diameter, reduced from \$14.75 to \$6.98! (Illuminated \$7.55!) Order today. Supply limited! (Add 40c to each price for postage.) New England Surplus Sales, Dept. PM-10, Newburyport, Mass.

LACHAPELLE'S Patented treatment, will make your motor better. Write, Ferns, Box 71827-B, Los Angeles 1, Calif., for information.

LEPT Throttle \$2.00. Sketch 50c. Dr. Claude Smith, Snohomish, Washington.

BUY Wholesale nationally advertised auto supply, thousands other products at big discount. Free "Wholesale Plan." American Buyers', 629-DD Linden, Buffalo 16, New York.

MOTORIST—Save gasoline vacuumating overrich mixtures. For free particulars, how to install on your car for introducing write, Vacuumatic, Dept. 2088, Wauwatosa, Wis. Salesmen wanted.

FREE Discount catalog—Speed, power, custom equipment. Almqvist Engineering, Milford 3P, Pennsylvania.

TAPPET Noises in Fords, Chevrolets and Mercurys stopped with Kaye Tappet Silencers. Free literature. Kaye Products, 2067B S. Layton Blvd., Milwaukee 15, Wis.

FIVE New auto specialties, sells on sight, want live distributor, good credit, U.S. and foreign territories open. Magic Seal Industry, 477 Wickson, Oakland, Calif.

THIEF Chaser, 10 days free trial! Protect your car, tires and accessories from theft. Guaranteed for 20 years. Salesmen wanted. Free literature. Novak Company, 3131 West 13th, Gary 110, Indiana.

INFLATE Tires by engine power. Super air pump guaranteed to fit spark plug opening of all tractors, trucks, autos. Inflates to 100 pounds pressure quickly. At farm stores or \$5.85 postpaid, check or money order. Super Manufacturing Corp., Chicago 6, Illinois.

PRECISION Du-All meter saves gas; indicates engine performance; 5 minute installation! Free utility box and manual. Money-back guarantee! Rush \$4.98 to: H. J. Pope Co., 18627 Detroit, Cleveland, Ohio.

BUCKET Seats \$12.95. Quick release belts \$6.93. Shoulder harness \$3.96. Both, \$9.99 postpaid. Ort, Dept. 109, Thomasville, Pennsylvania.

LAST From the light? Get out front with our water-alcohol vapor injector. Better mileage too. Easily installed, any car. Manufacturer direct for ridiculously low \$3.95 postpaid. Goltz Enterprises, Dept. M, New Hampton, N. Y.

GENUINE Motor treatment, Lachapelle's, (patented). Only \$3.00 delivered. Restores compression, power. Saves gas, oil, repairs. Money back guarantee. You can't lose. Free circular. Write Joe Dillon, Authorized Warehouse and Agents Distributor, Box 323-2, Bridgeport, Ohio. Exclusive distributorships agencies open.

KWIK-Start system cures car starting troubles. A boon in summer, a Godsend in winter. Saves battery. Fits all cars. \$3.95 postpaid. Money-back guarantee. Free information. Kwik-Start Co., 6000 No. Menard Ave., Chicago 30, Ill.

END Oil changing! Refine your oil as you drive! Refinol antiquates all other oil filters. Free booklet on saving your car or tractor motor. International Refinol Company, 8848 W. 47th, Brookfield, Ill. "Chicago's technical suburb."

CRANKSHAFT Grinder, hand operated. Makes bearings fit without taking engine apart. \$3.75. Literature. L. D. McGee, 719 Cascade St., Wenatchee, Wash.

STOP Auto radiator rust. Remove scale with Protecto rod. Free details. Godfrey, 1108 Jefferson Street, Boise 1, Idaho.

NEW Accessory stops headlight glare. Extra helpful in rain. Money back guarantee. Only \$2.95. Free literature. Olocar Light Controls Company, 126 N. Kensington, La Grange, Illinois.

SEE The new direct reading miles-per-gallon computer. 30c postpaid. Quantity discounts and imprinting available. Mrmco, 804 S. Ada, Chicago 7, Ill.

NEW And used parts at savings. Complete guaranteed parts service for all models cars and trucks—1924 and later. Largest in the West. Army parts specialists. No catalog, write for quotations. Fast mail order service. Pioneer Auto and Truck Parts Co., 734 W. 13th Avenue, Denver, Colorado.

CUSTOM Accessories headquarters. New summer catalog, just out, most complete ever. Jam-packed with items not in stores. New low prices. 25c. Eastern Auto, 3319-A South Grand, Los Angeles 7, Calif.

NOW Enjoy strainless driving with Lazy Leg left foot accelerator designed for your driving comfort. Relieves leg and back-aches. Easily installed in a few minutes on automatic or clutch shift cars. No interference with right foot accelerator. No alterations required. Transferable from car to car. A very useful accessory. Satisfaction guaranteed. \$3.98 plus 25c postage. Harris and Company, 249 Pequot Avenue, New London, Connecticut.

ELECTROPLATE Auto parts, novelties, mirrors. Easy, inexpensive home processes. Free booklet. Tyco Metals, Box 13231-BG, Houston 19, Texas.

BRUSH Plating outfits connect to a battery. No tanks or shop required. Free particulars. Gunmetal Co., Ave. J., Decatur, Ill.

CAR Burning oil? Losing compression? Try Clifford's Compression Seal. \$2 postpaid. Clifford's Engineering, 1329 Seventh, Aurora, Illinois.

FORD-T parts — Engine and chassis. Parts for other old models. Special parts made to order. B. S. Wisneski, Milwaukee 7, Wisconsin.

AUTO TRAILERS

BUILD Your own trailer! Plans for all kinds. Illustrated catalog 10c. Jim Dandy, 125-M, Wausau, Wisconsin.

ASSEMBLE Yourself kit. Slip-on cabin coach for pickups. Trailer blueprints. Literature 10c. Comstock Trailers, 585-P, Parsons, Kansas.

AUTOMATIC Hydraulic brakes for any trailer. Use standard auto parts. Detailed plans, instructions \$1.00 postpaid. K & P Engineer Associates, Box 492, Columbus 16, Ohio.

AIRPLANE Wheels, tires, tubes; new, used. Write for list and prices. Chris Stoltzfus, Coatesville, Pennsylvania.

EXCEPTIONAL Expanding eight foot trailer. Accommodates family of five. Build yourself. Literature 10c. Fra-Mar Company, Jones Avenue, Wilmington, Mass.

TRAILER Building, illustrated. 20c. Craftsmann Books, Box 1153, Milwaukee 1, Wis.

MOTORCYCLES, BICYCLES, MOTORSCOOTERS AND SUPPLIES

RECONDITIONED Motorcycles and motors. Chromium accessories. Complete stock Indian parts. Expert rebuilding. Fast service. Indian Motorcycle Sales, Kansas City 27, Mo.

SIDEWALK Automobile \$25.00; Cushman motorscooter \$25.00; Whizzer motorbike \$25.00; 1954 motorscooter \$40.00. Rush 25c (35c first class mail) for new catalog #856 listing many other amazing bargains in motors, midget cars, motorscooters, motorbikes, construction plans. Associated, Box 334, Toledo, Ohio.

"BUZZZZ" The motorcycle magazine. International coverage. Thoroughly illustrated. Yearly \$2.00. Sample 25c. 5424-A Sawyer, Chicago 25.

REBUILT Wasp 4 cycle bicycle engine kits. Cauffiel Motor Industries, Temperance, Michigan.

HARLEY-Davidson — America's best used buys! We pay shipping on motorcycles. Genuine new, used, parts, accessories for current and obsolete models. Send 25c for bulletin, catalog. Knuth's (Harley-Davidson factory dealer), 1753 Muskego, Milwaukee, Wis.

AVIATION

HELICOPTER—1 Man. Build own. Earn money, fame. Plans—\$3.00. Kerrigan Aircraft, 16525 Bramall, Detroit, Michigan.

FLY As a steward-purser. Work but 85 hours a month, starting salary \$235 up. G. I. approved, free catalogue. Air-Purser School, Room A, 1030 Nicollet, Minneapolis, Minnesota.

BUILD A helicopter jet engine yourself! "Practical Ram Jet Design" — \$1.00. Decker Engine Works, Plasterco, Va.

BUILD Jet helicopter. Complete plans \$6.25. Rovin Engineering, 219 Lytton Ave., Pittsburgh 13, Penna.

AIRCRAFT Engines, all makes 65 to 300 hp. for snow sleds and water boats. Aircraft parts and accessories. Free list. Vestco, Box 5306 T.A., Denver, Colo.

PROPELLERS, Plans, kits for snow sleds, air boats. Immediate delivery, satisfaction guaranteed. Catalog 25c. Banks-Maxwell, Box 3301E, Ft. Worth, Texas.

LIGHTPLANE Circular, illustrated, 20c. Craftsmann Books, Box 1153, Milwaukee 1, Wisconsin.

PROPELLERS, Plans, supplies for air boats, snow sleds. Literature. Gano Propeller, Box 3244A, Ft. Worth, Texas.

FREE: Monthly aircraft, electronic, gadget list. Dick Rose, Everett, Wash.

BATTERIES, GENERATORS

EDISON Nickel storage batteries. Any voltage, any amperage. Unconditionally guaranteed. Power plants, generators, motors. Literature. Hawley Smith Co., Croton Falls 1, N. Y.

ELECTRICAL SUPPLIES

LEARN Appliance service. Motors, washers, refrigeration, everything. Booklet. Manager, Box 73138, Los Angeles 3.

MOTORS, Rewinding supplies, instructions, manuals. Modern, Box 4704, Kansas City, Mo.

ELECTRIC Dropcords. 25 feet. \$2.00. Circular free. Dropcords, Box 52, Hempstead, N. Y.

MAGNET Wire, varnish, insulation. Electric Motor Service, 308 Delaware, Mason City, Iowa.

LAMP Supplies — Wholesale. Any amounts. All parts for repairing and building lamps. Catalogue 15c. Brown Lamp Co., Box 501-Wellston Sta., St. Louis 12, Mo.

LAMPS—25c Brings bargain catalog showing all parts for repairing, building. Contains instructions for electrifying vases, oil lamps, etc. Gyro Lamps, 5402P Clark, Chicago 40.

ELECTRIC Pencil: Engraves all metals \$1.50. Beyer Mfg., 10811-H Springfield, Chicago 43.

WELDING, SOLDERING, PLATING

A.C. Welders, four sizes. Lowest prices. Free literature. Holgeron's Service, Canton, Kans.

"BUILD-UR-OWN" a.c. welder and a.c. power plant with a good used engine and low cost Hobart generator. Welds anywhere and supplies 5KW stand-by power for any emergency. Write Hobartweld, Box M-1043, Troy, Ohio.

ELECTROPLATING Kits, tanks, supplies. Capitol, 4213-M Queensbury Road, Hyattsville, Maryland.

WELDERS, \$29.50, \$54, \$79.50. Absolute guarantee. Morris, 1070 Inner Drive, Schenectady, N. Y.

ELECTROPLATING Equipment, anodes and solutions for all types of plating. Instructions. Assemble your own plater and save. Free catalog. Ramyr, Dept. E-4, 1624 East First Street, Los Angeles 33, California.

MACHINERY, TOOLS, SUPPLIES

LOOK—New threading tool, for tail-stock of lathe. No setup required. Inexpensive, needed in every shop. Drill grinding jig, used with bench grinder. Free literature. Dealers wanted. Travis Tool & Machine Company, Sidney, Iowa.

SHEBEL Saw filer. Files all saws. Free trial. Circular. A. P. Shebel, 730 So. 2nd St., Milwaukee 4, Wis.

TOOL Catalog. Send \$1.00, refundable. Yuhas, 3350 Theodore, Detroit 11, Mich.

BALL Bearing table saws \$7.95. Sawco, 4675 W. Virginia, Denver 19, Colorado.

NEW Milling machine. \$89.50. Money back guarantee. Southern Machine Tool Co., Conyers, Georgia.

CARBIDE Tipped shaper cutters for wood, aluminum, plastics. Choice of 30 shapes. Low cost. Free literature. Write. Machinery Dealers, 606 W. Lake Street, Chicago, Illinois.

ALL Steel woodworking lathe, 5 x 12, \$9.95 prepaid. Circular. Sypher Co., 210 Cherry, Toledo, Ohio.

HEIGHT Gage \$1.00. Fits standard combination square. A. Webster, 1063 Sanford Ave., Irvington, N. J.

BIG Factory catalog! Buy direct—Save middleman's profits; hundreds of labor saving tools and equipment; tremendous savings. Send 10c. Master Mechanic Mfg., Dept. CL-36, Burlington, Wis.

ALLEN One ton power bench type punch press. \$97.50. Circular. Allen, Dept. PMB, Clinton, Missouri.

NEW Electric drills and saws. 1/4", \$11.75 and \$15.75; 1/2", \$30.75; 6/16" tilting arbor \$39.95. Prepaid. Wilt Surplus, 7829 Racine, Chicago 20.

TRUE Lathe chucks easy way. Send \$1.00. S. V. Height, Spring Lake, N. J.

REVOLUTIONARY Hand tool. Increases pulling power 31 times. Free literature. Multi-Use Puller, Box 971-M, Uptown, Hoboken, New Jersey.

ENGINES, MOTORS, DYNAMOS

ELECTRIC Motors. 1/4 horsepower \$6.95. 907 North Fifth, Philadelphia, Penna.

WINDING Data. 225 motors, single and three phase. \$1.00. Data Company, Box 7631, Kansas City 28, Mo.

REBUILT 1 1/2 To 3 h.p. engines \$17.00 to \$37.00. Cauffiel Motor Industries, Temperance, Michigan.

BOATS, OUTBOARD MOTORS

BOAT Kits. Build your own boat. Easy to follow instructions. Literature free. Paramount Boat Company, 2202 N. Prairie, Joliet, Illinois.

SEA Legs boat kits prices from \$39.00. Complete kits, including brass wood screws, precut parts, pre-assembled frames, foolproof illustrated instructions. Write for free literature. Penney Woodcraft Industries, Dept. C-28, Defiance, Ohio.

SECRETS Of outboard motorboat racing. Valuable book for every outboard driver. \$3.00 postpaid. Van Pelt Boat Co., Spring Lake 4, Michigan.

PLYWOOD Boat plans, 21 for \$1.00. Catalog boat building plans 25c. The Rudder, 15 Murray Street, New York 7.

BUY Wholesale nationally advertised outboards, thousands other products at big discount. Free "Wholesale Plan." American Buyers', 628-DD Linden, Buffalo 26, New York.

BOATS, Kits, accessories. Catalog 15c, refundable. Boatbuilders Marine, 55-M Sorrento, Allston, Mass.

BOAT Plans for amateurs. Simplified plywood types to 22'. What are your requirements? Glen Designs, Box 368, Comp-ton, California.

AIRPLANE Engines for air boat, snow sleds; complete power package, test run, ready to install. Write for descriptive list and prices. Chris Stoitzfus, Coatesville, Penna.

BOAT Covers, custom and ready made. Also tarpaulins, canvas yard goods, life preservers. Free boat cover catalogue. Morsan, 10-40R 50th Avenue, Long Island City 1, N. Y.

AIR Boat plans, supplies, catalog 25c. Banks-Maxwell, Box 3301F, Ft. Worth, Texas.

FULL Size, cut-to-shape boat patterns, blueprints, 7 1/2-38 feet. New 1954 illustrated "Build a Boat" catalog of 50 naval architect-designed cruisers, runabouts, sloops, skiffs, outboard boats, sailing, racing, houseboats, 50c. Marine hardware catalog, \$1.50. Bigger, better 1954 "How to Build Boats" book, \$2.50. PolyWog Houseboat Plans, \$12. Cleveland Boat Blueprint Co., Dept. A-66, 9400 Steinway, Cleveland 4, Ohio.

FIBERGLAS Your boat for permanent waterproofing. Easily applied. Complete instructions. Guaranteed materials. Wholesale prices. Complete kits \$12.00 up. Free list. Ajax Plastics, Dept. PM, P.O. Box 1323, Ft. Worth, Texas.

MARINE Conversions for Ford and Jeep engines. Catalog 10c. Lehman Manufacturing Company, 972D Broad Street, Newark 2, New Jersey.

NEW, Used, rebuilt marine motors. Marine conversions, fittings. Free catalog. Stokes Marine Supply, Dept. 24, Coldwater, Michigan.

BUILD Marine engines with Federal conversion kits. Federal Marine Motors, 9011 Cottage Grove Ave., Chicago 19, Illinois.

FREE Catalog! Boat kits, trailers, fiberglass, marine hardware. Luger Industries, Dept. KD, 3207 Fremont South, Minneapolis, Minnesota.

JOHNSON Outboard specialists. Used parts for all models at substantial savings. Prompt quotations. Specify model serial. Crandall-Hicks, 910 Commonwealth, Boston, Mass.

ATHLETIC EQUIPMENT, BODY BUILDING COURSES

BARBELLS, Exercise equipment. Courses. Free booklet. Good Barbell Co., Reading, Penna.

MEN'S French swim briefs. Zebra or leopard \$3.00. Maribill, Box 32, Garland 6, Texas.

GREAT Strength easily obtained. See page 42, Popular Mechanics, May issue 1954.

SPORTING GOODS, GUNS, FISHING TACKLE, ARCHERY, TRAPPING

IMPORTED, Daggers, stilettos, throwing, pocket, hunting knives, etc. Free catalog. J. D. Clinton, 94 Church, Mt. Clemens 2, Michigan.

FREE Fishing catalog—132 pages. Over 3000 hard to find fishing specialties. Net-craft Company, Dept. PM10, Toledo 13, Ohio.

BUY Wholesale nationally advertised sporting goods, thousands other products at big discount. Free "Wholesale Plan." American Buyers', 627-DD Linden, Buffalo 16, N. Y.

SLEEPING Bags, tents (direct from manufacturer), air mattresses, camping equipment. Low prices. Send 10c for 72 page illustrated tent-camping equipment-tent maintenance catalogue. Mor-San Sales, 10-21R 50th Avenue, Long Island City 1, New York.

SPEARFISHING, Diving catalog 25c. Underwater World, Box 475B, Huntington, New York.

FUR-Fish-Game, published monthly, contains abundant material on hunting, fishing, trapping. Newsstand price 20c. \$1.50-year. Get sample. Attach name, address, 10c to this advertisement. Mail today to Fur-Fish-Game, Columbus 15, Ohio.

SEMI-Finished bows and arrows. Catalog. Jim Deeds Archery, 5151 Branciforte Drive, Santa Cruz, Calif.

2000? YES—2000 Guns! Hunting specials. .30-.30's, Mausers, Lugers, Colts, Kentuckies. New, used, antique, modern guns. Accessories! Catalog 50c. Agramonte, 201 Warburton Ave., Yonkers 20, N. Y.

SAVE 50%. Finest bows, arrows, complete bowhunting outfits, etc. Free catalog and "How to Select Bow" booklet. Write: (Send 25c for "How to Bowhunt" booklet if desired). Malibu Archery, Los Angeles 5, California.

CALL Elk, deer, coyotes, foxes, etc. Original Animal Calls. Burley, Idaho.

CATALOG On government surplus from country's largest surplus organization specializing in outdoor, sporting goods, clothing, camping equipment. Hundreds of items including tents, rubber boats, tarpaulins, swim fins. Only 10c! Rockaway Sales Co., Dept. PM, Route 46, Rockaway, New Jersey.

MOLDS For fisherman's sinkers, jigs, squids, casting and spinning lures. Free catalog. Sweet's Molds, Tonawanda 1, New York.

HOLLOWGLASS Fishing rods. Save over half. Buy complete kits. Casting, spinning, fly and boat. \$4.95 to \$7.95. Assemble yourself. Full instructions. Makit Rod Company, Dept. PM, 429 Fulton, Ft. Worth, Texas.

5000 BARGAINS, Firearms, binoculars, war relics. Catalog 50c. Smith Firearms, Runnemeade, N. J.

180 PROFUSELY Illustrated pages antique pistols, swords, daggers, armor, etc. 50c. Robert Abels, M860 Lexington Ave., New York 21.

CAST Iron molds—For casting fishermen's sinkers. Free illustrated booklet. Reading Instrument Co., Box 78, Reading, Penna.

DIVING Equipment for spear fishermen, skin divers and professional divers. Send 25c for catalog. Desco, 234 N. Broadway, Milwaukee 2, Wis.

MANY Modern, antique guns. List 10c coin. Ed Howe, 52 Main, Coopers Mills, Maine.

GUNS, Reloading supplies, archery supplies, binoculars. Catalogue 10c. Gun Shop, Baker, Oregon.

JAP Rifle altering to 30-06, \$6.00. Japshells, \$3.75. Catalog 5c. T. P. Shop, West Branch 11, Mich.

PORTABLE Blinds: For duck, crow, goose shooting. Very light 4 x 5 ft. woven natural Tule mats. Strong. Excellent on duck boats and permanent blinds too! \$3.00 delivered. Peacock Broom Co., 915 Bryant St., San Francisco, Calif.

BIG Fish smell Quick-Catch bait from distance! You hook 'em fast! Bait easily made! Scientific directions, \$1. Star, 405 Madison, Fort Wayne, Indiana.

BINOCULARS, TELESCOPES, MICROSCOPES, MAGNIFIERS

DYNASCOPE—New sensational reflector telescope 65X-130X-167X; 4 power finder; fully achromatic; hardwood folding tripod, complete ready for use. Send for details. Criterion Manufacturing, Dept. DP5, Hartford, Conn.

FREE Literature. Ultra powerful telescopes and telescope makers lens kits at trifling cost. H. L. Jamer, Manorville 1, N. Y.

MICROSCOPES, Prepared slides, biological stains, oculars, illuminators, mechanical stages, objectives, mounting media, parts, specialized equipment. Premium quality merchandise, lowest prices anywhere. Write for free illustrated microscope catalog and price list. Benjamin Miller, 134 W. 32nd St., Rm. 204-A, New York 1, N. Y.

WAR Surplus bargains! Millions of lenses, instruments, telescopes, binoculars, components! World's greatest optical market place! Send only \$1.00 for beginner's 10-lens kit and big instruction booklet Stock "CH." Write for catalog "CH" free! Edmund Scientific Corp., Barrington, New Jersey.

BINOCULARS, Telescopes, microscopes, terrific values \$3.98 up. Request free money saving catalog. Criterion, Dept. P25, Hartford, Conn.

WORLD Famous Saturn telescopes, pyrex reflector kits, eyepieces, diagonals, abrasives, pitch, complete service for the amateur. Tinsley Laboratories, Inc., 2514-C Grove Street, Berkeley 4, Calif.

ELBOW Telescopes—8 power, new surplus, extra special \$18.95 prepaid. Buy 2 for \$35.00 with case. Lowest advertised price in country. Government cost \$200.00. Check or money order with order. Coronet Enterprises, Box 564, Rochester, New York.

SPACE-Rover astronomical telescopes, precision made. Rasmussen-Reece, Amsterdam, N. Y.

LIGHT Intensifier on electric light bulb gives three times the light on given spot. \$1.00 postpaid. Light Intensifier, 716 Vandyke, Detroit 14P, Michigan.

SPECIALISTS—Microscopes, prepared slides, supplies. Free catalog. Nassau Optical, 9 W. Greenwich, Roosevelt, N. Y.

GIANT 100X Telescope completely assembled with two eyepieces and heavy tripod, \$7.50. 400X telescope makers kit contains focusing tube, erector, 5 lenses and instructions. \$3.75. Suffolk Science, Mattituck 3, N. Y.

TELESCOPES—20 Power, new surplus. \$400.00 value, special \$89.50 with free \$50.00 leather carrying case. Shipping weight 40 lbs. Check or money order with order. Coronet Enterprises, Box 564, Rochester, New York.

AMAZING Prices, binoculars, telescopes, microscopes. Free trial. Folder, "Binocular Selecting," catalog free. Dealers wanted. Prentiss Importers, Mercury Bldg., West Los Angeles 25, Calif.

SAVE 25%! Get interesting facts. Free 52 page binocular, telescope catalog. \$3.95 to \$250.00! United, 9043 S. Western, A-7008, Chicago 20. Dealers wanted.

LOWEST Prices, all sizes binoculars, telescopes, microscopes, 8X30 \$32.00. Free catalogue. Joe's Binocular Sales, 4827 Second Blvd., Detroit 1, Michigan.

TELESCOPES, Microscopes, binoculars for quarter century. Big bargain scientific catalog 10c. Harry Ross, 70 West Broadway, New York 7, N. Y.

REFLECTING Telescopes, 60X, completely assembled \$29.75. Guaranteed observatory clearness. Free information. Skyscope, 475 Fifth Avenue, New York 17.

MAKE 6" Telescope reflector. Glass, abrasives, instructions—\$10.50. F. Cameron, Box 65, Inwood 96, N. Y.

REFLECTOR Telescope kits from \$6.25. All parts designed and built at our Hoboken factory. Mirror cells, diagonals, focusing mounts, tripods, tubing, oculars. Fully guaranteed. Free illustrated catalog. Easy time payments and lay-away plan available. Send orders and inquiries to Esco Products, Dept. PM-4, 1428 Willow Avenue, Hoboken, N. J.

PETS—DOGS, BIRDS, RABBITS, HAMSTERS, ETC.

TROPICAL Fish, goldfish, live better, longer when fed Peekskill food. Formula A-Liver, B-Fish, C-Spinach, G-Goldfish. Send 75c for three jars prepaid. Booklet. Peekskill Pet Supply, Peekskill, N. Y.

GUINEA Pigs. Wonderful profits. Booklet free. Taylors Company, Hapeville, Georgia.

CHINCHILLAS—Registered. Guaranteed reproduction. Unbelievable price. Far-West Chinchilla, 1446-A Jones, San Francisco 9, California.

HAMSTERS—Golden; young, \$4.00 pair, fully developed, \$5.00 pair. Adirondack Hamstery, Prospect 40, New York.

FREE—Dog and cat remedies, supplies, toys. Catalog. Norvet, Hartford 3, Conn.

RAISE Rabbits. Wonderful proposition. Booklet free. Tayco Rabbitry, Hapeville, Georgia.

HAMSTERS, Albino and golden. Select breeders. Circle 8 Hamstery, Box 163W, Claymont, Del.

HAMSTERS—Retail and wholesale. Prices free. Anderson's Hamstery, 35 Oneida, Pontiac, Michigan.

PARAKEETS, Profitable hobby, read Parakeet Newspaper, Box 46, West Bend, Wisc., 8 months \$1.00.

CHINCHILLAS—Big profits. Free literature. Tom McGowan, 170 Horton Ave., Valley Stream, L. I., N. Y.

CHINCHILLAS (No rabbit.) Easily raised anywhere. Profitable. Big future. Terms. Hibner Chinchillas, Ithaca, Mich.

AMAZING Profits raising chinchillas, pigeons, rabbits or cavia for us. "Free Information." Keeney Brothers, New Freedom 2, Penna.

BEAUTIFUL Pure white pedigreed police puppies. Ansonia Kennels, Mose, N. Dak.

SPORTSMEN: 200 Pointers, Setters, Straight Cooners, combination hunters, rabbit and fox hounds. Reasonable. List free. Ramsey Creek Kennels, Ramsey, Illinois.

HAMSTERS—Rare Albinos; young, pair \$7.00. I. C. Gengler, Caledonia, Minn.

RAISE Mink: Free booklet, pen plans, inside secrets, feed care. Mink are money makers. Investigate today. Lawrence Morgard, Brigham City 12, Utah.

CHINCHILLAS. Profitable business operated in cellar or spare room. Quality registered stock. Guaranteed. Delivered personally. Full care instruction. Stewart Chinchilla Ranch, Washingtonville, N. Y.

MINK—Easily raised anywhere. Top quality breeders. Free information. Huebl Minkery, LeSueur, Minn.

RAISE Moneymaking Angora, New Zealand rabbits. Particulars free. White's Rabbitry, Jackson, Mich.

FOR Sale: A few outstanding coon-hounds, beagle, and rabbit-hounds. Prices from \$15.00 to \$40.00. Free literature. Trial. Dures Thomas, Box 268, Albertville, Alabama.

STANDARD Rabbit Journal, Milton 3, Penna. Year \$1.00. Sample dime. Beginners manual 25c.

GROW Mushrooms. Cellar, shed, and outdoors. Spare, full time, year round. We pay \$3.50 lb. We paid Babbitt \$4,165.00 in few weeks. Free book. Washington Mushroom Ind., Dept. 171, 2954 Admiral Way, Seattle, Washington.

MAKE Big money! Raise Chinchilla rabbits. Cash markets supplied. Write today! Rockhill Ranch, Sellersville 15, Penna.

MINK Raising information free. Complete. Lake Superior Mink Farm, Superior, EE1, Wisconsin.

FARMS, FARM LANDS, REAL ESTATE

FLORIDA—Nice homesites near Ocala national forest in Lake county. Best fishing, hunting. Low prices, easy payments. Folder free. Howard Vernor, DeLand, Florida.

HOUSTON Celebrated its million population day on July 3rd! America's fastest growing city now accumulating its second million. Learn all about fabulous Houston's phenomenal money-making homesites for \$345. Easy terms. Full information—free. Preston Wood, Box 413, Houston, Texas.

\$25 MONTHLY Buys three residential lots in West Palm Beach, Florida. Price \$3000. Uribe, Dauphin, Manitoba, Canada.

FARM And business catalogs free! 4 big editions, Florida, Northeastern states. West's, M-10, Pittsburgh 17, Penna.

FLORIDA Winter garden farms—Near famous Panama City pleasure resort. Marvelous beaches. Wonderful fishing. Beautifully wooded 10-acres for \$995, payable \$25 monthly. Grow fruits, berries, vegetables, poultry, Tung groves! Finest development in Florida. Guaranteed! Booklet free. Wendell Wood, Fountain, Florida.

FLORIDA—Beautiful retirement homesites near gulf coast. Excellent hunting, fishing in 9 fresh and salt water rivers. 11 bays and gulf. \$250 at \$10 monthly. Free literature. V. M. Mathews, Box 1406, Asheville, N. C.

BIGGEST Ozark listings mailed free. Lowest prices. Armstrong, Shook, Missouri.

HOMESITES \$400—Convenient payments. California's finest garden section. On Morro Bay's scenic shores. Wonderful fishing, boating, bathing. Fertile soil, softest water, temperate climate, congenial community. Free literature. Richard Otto, Department M, San Luis Obispo, Calif.

\$5.00 MONTHLY Buys 40 acres productive land; near town. Price \$240.00. Free list. Box 425-P, Carthage, Mo.

MAKE Money in Texas. Get yourself a fine tract now near Houston for only \$345. Pay \$15 cash and \$15 monthly. Fastest growing city and second largest seaport in the U. S. Huge \$100 million steel plant. World's greatest oil producing, refining, chemical, manufacturing and shipping center. Many are making phenomenal profits here and you can too. These beautiful tracts located in Houston's desirable southside suburbs with all-weather streets, electricity, schools, bus service, etc. Insured title. Write today for maps, pictures, full information free. Wood, Owner, Box 6804, Houston 5, Texas.

NEW Strout catalog. Just out! Mailed free! Farms, homes, businesses, 35 states, coast-to-coast, over 3000 bargains described. World's largest: 54 years service. Strout Realty, 7-M So. Dearborn St., Chicago 3, Ill.

PLANTS, SEEDS, NURSERY AND GARDEN SUPPLIES

25 EVERGREENS \$5. Healthy, selected trees, 6" to 16" tall, three to five years old. Five each of Colorado Blue Spruce, Norway Spruce, Austrian Pine, Scotch Pine, and Douglas Fir. Shipped postpaid September to November. Free fall planting list. Musser Forests, Inc., Box 91-C, Indiana, Penna.

GROW Miniature trees. Banzai method exposed. Complete, simplified instructions. \$1.00, returnable. Revealer, 1749 Gr. Concourse, New York 53.

6 RHODODENDRON \$4. Nursery-grown, hybrid transplants, grown from red-flowering plants, 4" to 6" tall. Shipped postpaid September to November. Free fall planting list. Musser Forests, Inc., Box 91-C, Indiana, Penna.

GINSENG. Goldenseal roots bring \$2-\$12 pound. Full information. M. Collins, Viola, Iowa.

PROFITABLE OCCUPATIONS

WANT A diesel job? New opportunities to increase income. Higher pay. More money. We can help you qualify. Tools. Shop method home training. Write today! Diesel, Tractor, Heavy Equipment Division, Interstate Training Service, Dept. B-3-K, Portland 13, Oregon.

MAN Wanted—Are you dissatisfied with your work? Would you like a business of your own? If so, write Rawleigh's, Dept. J-GG-PPM, Freeport, Ill.

ARTISTS Make money—Booklet free. Drawing, painting, advertising art, cartooning; one enjoyable course; start at home. Write for free illustrated book, "Art For Pleasure And Profit." Our 40th year. Washington School of Art, Studio 4210N, Washington 5, D. C.

FREE! "301 Profitable Small Businesses!" Amazing shoestring plans! Work home! Start sparetime! Deumant Surveys, Kenmore 23-R, N. Y.

INTELLIGENT Men, women, make excellent incomes asking survey questions. For booklet describing how to start and listing 110 top survey firms send \$1.00. Guaranteed. Research Service, Dept. E, Box 253, Wilmette, Illinois.

SECRET Investigation. Experience unnecessary. Investigators particulars free. George Wagoner, 125 M West 86th, New York 24.

BUY Wholesale thousands nationally advertised products at big discount. Free "Wholesale Plan." American Buyers', 628-R Linden, Buffalo, N. Y.

POSTCARD Brings employment listings galore. Randall, 501 Ogden, San Antonio 2, Texas.

"HOW To Make Money With Simple Cartoons"—A book everyone who likes to draw should have. It is free; no obligation. Simply address Cartoonists' Exchange, Dept. 910CP, Pleasant Hill, Ohio.

FOREIGN—U.S. jobs. So. Am., Alaska, Spain. Fare paid. 1000's U.S. jobs to \$18,000. Trades, office, factories. Stamped self addressed env. brings reply. Job Opportunities, Waseca 10, Minn.

\$1300.00 MONTHLY For truck drivers. \$1400.00 monthly for carpenters, electricians, plumbers, mechanics, \$1200.00 for clerks and laborers. Replacement hiring now being done. Full information and complete foreign listings, with current information on Spain, Korea, Australia, Alaska and Canada, \$1.00. 10,000 men and women needed for new stateside project! Complete information and other domestic listings. \$1.00. Dept. 3-J, Opportunities Unlimited, 1110 Commerce Bldg., St. Paul, Minn.

MUSHROOMS Grown boxes, barrels. Manureless process 50c. Spawn \$1.00. Gordons, 553 William, Winnipeg, Manitoba.

MAGAZINE Subscriptions—Largest commissions. Bonus. Qualified Publications, 451B Kingston, Brooklyn 25, N. Y.

WELDING Pays big money. Learn easily at best equipped school in country. Non-profit school with low cost training. G.I. approved. Write Hobart Trade School, Box M-1042, Troy, Ohio.

SELL Popular Mechanics and all other magazine subscriptions. Free catalog, supplies. Subscription Service Company, Dept. B, P.O. Box 2070, Birmingham, Ala.

SIGN Painting pays amazing profits. You do professional work using "All-In-One" master letter patterns. Windows, buildings, trucks, banners, cards, cutout letters. Complete set 1 1/2" to 12" with instructions \$1.00 prepaid. Eyerly Co., B-583, Newton, Iowa.

\$10,800 PROFITS! Your own mailorder business! No risk! Success plan free! Treasury, 709 Webster, New Rochelle L-25, N. Y.

FREE Folio "\$45,000; Unlimited Vacations Plan." No merchandise, equipment. Unknown! Work home—sparetime. Proven successful! Haylings, Carlsbad, Calif.

"LATEST Copyrighted Reports" Who to contact for highest paying jobs in over 38 countries, including U. S., Spain, South America, Alaska, Europe, Africa, Canada, etc. Listings of employers with contracts who hire skilled, unskilled, professional, supervisory, clerical, trades, laborers, many others. Pay up to \$1550 monthly. Also best oil, aviation, mining opportunities. Only \$2. Airmail \$2.25. (C.O.D.'s accepted). Includes one year registration and advisory service. Application forms. We can help you find employment. Only service with unconditional guarantee of satisfaction or money back. Immediate service. International Reporter, Box 1047-PH, St. Louis 1, Missouri.

ALASKAN Jobs! Over 150 new construction projects with names, addresses, companies hiring. Thousands needed. Highest wages. Military, private construction, mining, fishing, lumbering, aviation, railroads, homesteading. Skilled, unskilled workers. Salary information. Alaskan map included. Sample application \$1.00 complete. Alaskan Opportunities (PM), Box 362, Kenmore, Washington.

ELECTRONIC Parts distribution offers you a future at top pay. Write Glenn Williams, 6750 S.W. 8th St., Miami, Fla. and enclose \$2.00 for information on this desirable, uncrowded field.

FOREIGN Employment construction work. If interested in foreign projects with high pay write Foreign Service Bureau, Dept. PM, Metuchen, New Jersey.

BE Your own boss. I can show you how to own a Cadillac, hire your own help and retire on little capital. \$1 guarantees 806 successful plans. E. White, 1364 Conejo, San Bernardino, Calif.

HELP Wanted, highest salaries. New York City classifieds airmailed—\$1.00. Miller, 24 Whitewell Place, Brooklyn 15, N. Y.

HOME Workers needed! Spare time, full time. Assemble luggage and cases with our complete illustrated step-by-step instructions. We sell your product—Supply everything. Manufacturing representative needed in your area immediately. Unlimited profits possible. Investigate at our risk. Free details. Cascraft, 807-G10 Sunset, Los Angeles 12, Calif.

SPARETIME Profits. Make genuine leather handbags, moccasins, billfolds, belts, novelties for gifts or to sell. Miles Crafts, 3220-P Fish Avenue, New York 69.

ST. Lawrence Seaway starting. Tenders called. Send \$1.00 cash or money order for information and application form. Airmailed 25c extra. Allied Opportunities, Box 10, Station B, Dept. PM-10, Hamilton, Ontario, Canada.

\$15 AN Hour preparing tax returns. Become tax expert. State approved training program. Union Institute, 2-0, Lakewood, New Jersey.

MAKE Flexible molds. Cast figurines, plaques. Free sample. Tooker, 630-M Chestnut, Hamilton, Ohio.

EVERYBODY Likes candy. Learn to make professionally. Our 44th year. Ragsdale Candies, D6, East Orange, New Jersey.

FOREIGN, Latin American, domestic employment. 1954 "Foreign Service Directory" originator of job news by copyright, gives up-to-minute facts on military and civilian construction; Canadian, Alaska construction; major oil companies; aviation; manufacturers; steamship lines; mining; importers-exporters; how-when-where to apply with application form. Free—Hot list firms hiring. \$1.00 postpaid. Global Reports, Box 883-P, Hollywood 28, Calif.

GROW Mushrooms. Cellar, shed, and outdoors. Spare, full time, year round. We pay \$3.50 lb. We paid Babbitt \$4,165 in few weeks. Free book. Washington Mushroom Ind., Dept. 99, 2954 Admiral Way, Seattle, Wash.

BE The Popular Mechanics representative in your neighborhood and earn big profits in your spare time. Write Popular Mechanics Magazine, Room 408M, 200 E. Ontario St., Chicago, Ill.

FREE Book "505 Odd, Successful Businesses." Work home. Expect something odd! Pacific, Oceanide, Calif.

EARN \$3.50 To \$15.00 per hour in your spare time refinishing and patching furniture. Repair professionally scratches, dents, nicks, cigarette burns, etc. Particulars free. Sunshine City Refinishing Products, 3800 Maple St., Northeast, St. Petersburg, Florida.

TYPISTS—Profitable home business. Complete copyrighted information, 50c. Gaunt, 827 Irving, Chicago 13.

AUCTIONEERING—Home study course. Diploma granted. Auction School, Ft. Smith, Ark.

FREE Information now available about foreign and U. S. A. job opportunities paying to \$1500 monthly. Write immediately. Dept. AG, National Employment Information Service, 1020 Broad, Newark, N. J.

MAKE New greaseless doughnuts in kitchen. Sell stores. Free recipes. Michael Ray, 3605 South 15th Ave., Minneapolis 7, Minnesota.

RAISE Pheasants on \$100 week plan. Little capital and space can make you independent. Free details. Great Central System, Columbus 20, Kansas.

BOOKS, PERIODICALS, PICTURES, POSTCARDS

BOOKHUNTERS! Scarce, unusual, miscellaneous books supplied. Atlantic Book Service, Cedar Street, Charlestown 29, Massachusetts.

BOOKHUNTERS! All subjects. Send wants! College Book Service, 52 W. Kingsbridge Rd., New York 68, N. Y.

"FEMME Mimics"—Amazing book, containing 375 photographs. About men who wear women's clothing! Free literature. Winco, Dept. PM101, Box 9525, Dallas, Tex.

FREE Catalog paper covered books. World Adventure, B438H, Ann Arbor, Mich.

BOOK Catalogue, 1000 bargains, send 10c. Books Publishers, Amityville 3, N. Y.

SPARETIME Profits taking subscriptions, all magazines. Wholesale catalog free. Cassell Agency, Westfield 2, New Jersey.

NATIONAL Geographic Magazines. 1888-1952. Periodical Service, Box 465-PM, Wilmington, Delaware.

BOOKS Found! Any author, old or new. Rush titles wanted; no obligation. International Bookfinders, Box 3003-PM, Beverly Hills, California.

BOOKHUNTERS! All subjects. Send wants! Jaher Book Service, 620-P East 178 Street, New York 57.

BOOKS Galore. Illustrated comic booklets. 24 all different \$1. Catalogue 10c. Aladdin Book Co., 210-PM Fifth Avenue, New York 10.

GAMES, TOYS, NOVELTIES

AMAZE Your friends! Tell fortunes with cards. Instructions and special cards \$1.98. Send money order or check. Gulf States Distributing Co., 8405 Montridge Drive, Houston 24, Texas.

MAGIC TRICKS, PUZZLES, JOKER NOVELTIES

FLOATING Rock! Amaze your friends. Actually floats in water. Of volcanic origin from an ancient sea. Generous specimen \$1.00 postpaid. Mineral Research, Box 151, Fontana, California.

BECOME Professional comedian! Free details! Sebastian, 10934-X Hamlin, North Hollywood, California.

MAGIC Picture card. Sample 25c. Mandel, 1200 Avenue H, Brooklyn 30, N. Y.

VENTRILOQUIAL Dummies, courses, scripts, monologues, etc. Send 35c for catalogue. Gough, 218 N. Jefferson, Hartford City, Ind.

BOIL Water by cooling. Instructions 10c. Glaser, 84 N. Clinton Ave., Trenton, N. J.

FREE Bag full of amazing tricks. Send dime for handling. Starling Co., 2206M Starling Ave., New York City 62.

500 TRICKS, Douglas famous 120-page catalog, only 10c. Fastest service to magicians for 30 years. Send 10c today. Douglas Magician, Dept. 1, Dallas, Texas.

WE Supply every noted magician. Large professional catalog \$1.25. Holden's, 120 Boylston Street, Boston, Mass.

2500 TRICK Catalogue (512-pages), pocket, parlor, stage. World's finest magic, Catalogue \$2.00 (dollar trick included free). Kanter's, M-1311 Walnut, Philadelphia 7.

PROFESSIONAL Catalog, 175 pages, 25c. Williams, 900 Plymouth, Ellwood City, Penna.

MAGIC Courses. Catalog with seven lessons free! Success School, Sparta 6, Michigan.

3100 NOVELTIES, Tricks, jokes, gadgets, funmakers, hobbies. Catalog 10c. Johnson-Smith, D852, Detroit 7.

COINS, TOKENS, CURRENCY

OLD Money wanted. Will pay fifty dollars for nickel of 1913 with liberty head (no buffalo). We pay cash premiums for all rare coins. Send 4c for large coin folder. May mean much profit to you. Numismatic Co., Dept. 20, Fort Worth, Texas.

AN 1804 Silver dollar is worth \$12,500! What are your U. S. coins worth? Fell's new 1954 U. S. coin book. Everything on every coin minted—worth, selling, speculating, investment, etc. Clothbound, profusely illustrated. Send no money. Pay postman \$2 (plus postage) or send \$2.00 (postpaid), refundable. Fell Publishers, 386-M-7 4th Ave., New York City 16.

20 FOREIGN Coins \$1.00. Valley Coinco, Box 66, McAllen, Texas.

KNOW Your money—Coin handbook \$1.00; currency catalogue \$1.50. Large \$1.00 bill \$2.50, new 3.95, 15 different Indian cents \$1.00. Giant bargain catalogue 35c. Bebee's, 4514 North 30th, Omaha 11, Nebraska.

40 DIFFERENT Selected coins \$1.00. Oddehon, Box 482, St. Louis, Mo.

FIFTEEN Different Indian cents \$1.00. Sayers, 1000 East Unaka, Johnson City, Tennessee.

BARGAIN Lists and uncirculated coin 10c. Elliott, 235 Juniper, Coraopolis 6, Penna.

FOUR Page bargain list, five Indian-head cents, 25c. Economy Sales, 156 Dean, Mansfield, Mass.

FOREIGN Coins, twenty different each from a different country, \$1.00 postpaid. Webb, 330 Gough, San Francisco 2, Calif.

JAPANESE Invasion notes 1c to \$1000.00 set \$1.00. 100pp. illustrated coin catalogue, 25c. Shultz, Salt Lake City 10, Utah.

FREE! Foreign coin, banknote and coin collectors illustrated catalog to approval service applicants. Send 3c postage. Tatham Coinco, Springfield 30, Mass.

INDIAN Cent with bargain lists 10c. Hutchinson, 3443 "T" Street, Philadelphia 34, Penna.

GET Profit and pleasure in collecting old coins. Send 10c for 36-page illustrated coin catalog. You'll be delighted with it. Send for it now. B. Max Mehl, 370 Mehl Building, Fort Worth, Texas. Largest rare coin establishment in U. S. Established 54 years.

CONFEDERATE And Southern bank notes, 3 different, \$2.00. 50 mixed Indian pennies, \$2.00. Ben's Coin Shop, 31 N. Clark, Chicago 2.

WORLD'S Greatest magazine for coin collector's and wooden nickel 10c. Lawrence Brothers, Anamosa, Iowa.

COIN Collector's Magazine. Over 1000 pages per year. Sample copy 30c; \$3.00 per year. Hewitt, 7320-J Milwaukee, Chicago 31.

U. S. Large cent, 2c, 3c all for \$1. Bargain list included. Delmaco, Box 1123, Wilmington, Del.

UNITED States Rare Coin Value Guide, 48 pages 50c. Fortunes in rare coins. Ideal, 4644-P Geary, San Francisco 18, California.

WANTED—1894-S dime pay \$500.00. Certain 1913 nickel \$1,000.00. 1901-S quarter \$20.00 to \$150.00. Hundreds of others. Know their true value. Complete illustrated catalogue 25c. Worthycoin Corporation, (D-325), Boston 8, Mass.

STAMP COLLECTING

FREE! Giant U.S. price list! Special: mounted collection 550 diff. United States only \$11.00. Goliath Co., Bethlehem 21, N. H.

EXCITING Treasure hunt! Big cloth bag containing 1000 stamps, unpicked, unsorted, just as received from foreign missionaries, banks, etc. Over 30 countries. Postpaid, guaranteed, only \$1.00. Harrisco, 743 Transit Building, Boston 17, Mass.

FIRST U.N. set. Among world's prettiest. Only 10c. Approvals. Welles, Box 1246-R, New York City 8.

77 DIFFERENT U.S. 25c. Approvals. Utechs, 1142D North Keeler, Chicago 51.

ICELAND Fish set free, with beautiful pictorial approvals. Van Fleet, 182-A East Beresford, Highland Park 3, Mich.

FREE United States illustrated catalog. Bailey, 44 Bromfield, Boston, Mass.

NO Rareties, no junk, just good solid approvals for serious collectors. Dominion Stamp Company, Arlington, Va.

LESS Than one-tenth catalog. Collection of 19th century British Colonies catalog over \$2.00, just 20c with approvals. Viking, 11-2 Northern Blvd., Great Neck, N. Y.

UNITED States price list 100 pages, hundreds of illustrations, stamp identification 10c. Thom, 4808-15 Ave., Minneapolis 17, Minn.

1500 STAMPS \$1.00. Good variety. World wide. Many pictorials. No approvals follow. Satisfaction guaranteed. Whalen, 1516 First Ave., Oakland 6, Calif.

NOT 5, Not 10, but 15 giant stamps 10c with approvals. Premiums each purchase. Heritage Hobbies, 52 1/2 Balmforth, Danbury, Conn.

TRIANGLES, 11 Different, each a giant bi-color stamp. A real 50c value for only 10c to those requesting our jumbo approval selections. Wolverine Stamp Service, Dept. A-21, Fruitport, Mich.

1500 MIXED Foreign stamps \$1.00. No approvals. Aaron, 789 Valencia, San Francisco 10, Calif.

CIPEX Souvenir sheet plus 25 different U.S., 10c. Approvals accompany. Village Stamps, 90-39P 214 St., Queens Village 28, N. Y.

BELGIUM 100F. Pictorial catalogues \$1.00. Only 10c with colorful approvals. J & P Stamps, Box 1112R, East Detroit, Michigan.

FREE Congo flower stamps. Approvals. Pearl, 765 Carl, New Kensington, Penna.

U.S. Personalized approvals. Dick Kurtz, 3024 So. 31, Omaha 5, Nebr.

GOYA Nude (2) 5c. Approvals. Hanney's, 310 Quail, Albany 3, N. Y.

PEELABLE Address labels, 200 \$1.00. Sample free. Billey, Castle Rock, Minn.

WORLD'S Finest approvals, 1/3 Scott, Palmstamp Co., Box 35211, Los Angeles 35, Calif.

BEAUTIFUL Mixture. Off paper. 250 mixed 50c. Chase, Box 771, North Adams, Mass.

BRITISH Colony pictorial mixture. Over \$10 catalog value in different large size stamps for \$2. L. H. Brightman, 199 Prospect, Long Beach, Calif.

AUSTRALIA: 47 Different, 10c. Illustrated lists free. Leslie Anderson, Seaside Heights, N. J.

CANADIAN Queen Elizabeth set complete 10c with approvals. Northern Stampco, Box 371, Kingston, Canada.

101 DIFFERENT, 10c With approvals. Worldwide, Box 815, San Francisco, Calif.

BEAUTIFUL Collection free! Send postal card now! Drakeco, 4415 South Troy Street, Chicago 32.

125 COMMEMORATIVES—All U.S. All different. \$1.00 with approvals. Hobbycrafts, Bandon, Oregon.

FREE! Price list of 250 different collector's supplies, albums. Approvals. Littleton Stamp Co., Littleton 01, N. H.

100 DIFFERENT World 10c gift set. Belle, Mapledale, Hazel Park, Mich.

WHOLESALE Price lists for dealers. Progressive, 270G Burkhardt, Cincinnati 15, Ohio.

TWENTY Different topical stamps ten cents. Catalog value \$1. Packets list free. K. Affleck, Vienna 4, Virginia.

DIFFERENT, 500, 50c; 1000, \$1.25; 2000, \$2.75; 5000, \$11.00. Approvals. K. S. Holmes, London, Canada.

MINT U.S. approvals free list: singles blocks, plate blocks. Commemoratives, all mails, regular issues. Select mint copies guaranteed to please. Fast service, prices you can afford. Special introductory offer: 33 different mint U.S. commemoratives \$1.99 different mint U.S. commemoratives \$5.20 different mint U.S. air post stamps \$3.60 different mint U.S. regular issues \$5.11 different mint comm. plate blocks \$2.50 different mint comm. plate blocks \$9. All select mint. Satisfaction guaranteed. Only 1 of each lot (max. 6) to a customer. Give your age, employment, references and number of mint U.S. in your collection. Approvals accompany. Write today! Now: Russell Patrick, 3550 East 42nd Street, Indianapolis 28, Indiana.

5 MINT Blocks free to approval applicants. A. H., 1207 Northland Ave., Buffalo 15, N. Y.

BOOKLET—Free! "Stamp Collecting—Ten Easy Lessons." Approvals. Howard Moser, Highland, Illinois.

BRITISH Africa, 20 different 25c. Approvals? S. Penniston, Norborne, Mo.

FREE Complete set of famous Americans, flags, parks and presidentials to approval buyers. Send 5c for 15 of the above stamps plus full particulars. Tribore Stamp Company, 145 Nassau Street, Dept. 110, New York 38, N. Y.

FREE, Fabulous, fun—Gigantic Rebus puzzle contest open free to approval buyers. First prize—10,000 all different stamps cataloguing over \$300.00. Many other prizes including Master Global and International albums. Valuable consolation prizes to all unsuccessful contestants. You can't lose. Rush 10c to cover postage and handling for details, approvals and surprise packet. The Explorer, Box 105A, Times Plaza Station, Brooklyn, N. Y.

315 DIFFERENT Foreign stamps including animal, flower and other topicals. Air-mails, coronation and triangle stamps. 25c with approvals. Hathaway, P.O. Box 145PM, Garden City, N. Y.

FINE Foreign stamps on approval. Laddy, Evanston Bldg., Minneapolis 2, Minn.

FREE!—Big United States catalog. Valuable guide and check list. Hundreds of illustrations. Approvals. Harrisco, 468-I Transit Bldg., Boston 17, Mass.

FINE Approvals. Fast, personal service. What countries do you prefer? I'll send their stamps. Skinner, 438 Locust, Long Beach 12, California.

100 JAPAN 10c. All different, with approvals. Gould's Stamps, Box 631, San Francisco 1, Calif.

GIGANTIC Collection free. Includes triangles, early United States, animals, commemoratives, British Colonies, high value pictorials, etc. Complete collection plus big illustrated magazine all free. Send 5c for postage. Gray Stamp Company, Dept. PM, Toronto, Canada.

FREE U.S., U.N., Confederate states catalogue for stamps, albums, supplies. America's lowest prices. Stone's, 45 Bromfield, Boston 8, Mass.

UNITED States sets, unused. Flags 85c, Parley parks \$1.60. Presidential coils 55c. Catalog 10c deductible on \$1.00 order. Standard, 10840-E Woodview, Parma Hts. 30, Ohio.

PENNY Approvals with something special. Sturgeon, 2112 Dodson, Ft. Smith, Arkansas.

FREE. Scott's International Album. Other premiums. Particulars with approvals. Raymax, 35-Z Maiden Lane, New York 38.

FREE 50 Year old Canada set with bargain approvals and blocks. Send 10c postage. Roderick Pullen, St. Marys, Ontario, Canada.

135 DIFFERENT U.S. commemoratives \$1. Request approvals. Harold Holub, 18 East 198th Street, New York 68, N. Y.

GREATEST Free offer—Croatia exile government air set; gorgeous birds, natural colored triangles. Also albums, supplies. All to our approval buyers. Bell Stamp Service, Dept. S-5, Bell, California.

300 DIFFERENT Sarawak, Mauritius, worldwide, 25c. Garrow Stampco, Chula Vista, Calif.

GERMANY 1947 "Reaching for Peace" issue 3c to approval applicants. Carlson, 8 Esther, Pasadena 3, California.

HOW Many of your album pages need only a few stamps to complete? Want to fill those pages? Try our big approval books of 1000 varieties at 1c and 2c each. Our values will amaze you. Write today. Roseland Stamp Co., Dept. A-31, Spring Lake, Mich.

FREE U.S.—35 different, with superior approvals, Sparta, Box 1082, Rochester 3, N. Y.

SOMETHING New, something different, something terrific. Try our books of 1000 different and see for yourself. Mostly 1c and 2c but Scott's catalog number and price under each stamp. Big discounts. Modern Stamp Co., Dept. A-5, Ferrysburg, Mich.

MINIATURE Sheets. Outstanding collection of fascinating stamp issues including miniature sheets. Low cost yet beautifully different. Send 25c for sample lot. Myers, Box 327, Williamsport 3, Penna.

SCOTT'S American stamp kit includes looseleaf American album, 125 different U.S. stamps, watermark detector, tongs, hinges, perforation gauge, \$4. Album separately, \$2.50. Scott Publications, 580 Fifth Avenue, New York 36.

OLD Stamps wanted. I will pay \$100.00 each for 1924 green Franklin stamps, rotary perforated eleven (up to \$1,000.00 each unused). Send 10c for large illustrated folders showing amazing prices paid for old stamps and coins. Baker Stamps, (PM-410), Elyria, Ohio.

FREE—10 Diff. Canada, with approvals. Guy Stamp, 5165-5th Ave., Rosemont, Montreal, Canada.

WORLD'S Oldest stamp! 1840 Great Britain 1p. \$9.00 catalogue. Spectal, \$1.00. Approvals, Brooks, 2352X East 23rd Street, Brooklyn 29, New York.

1000 DIFFERENT 50c. Approvals. Ouellete, Box 66M Flint, Fall River, Mass.

CLOSEOUTS! Miscellaneous sets half price, on approval. Variety Stamp Service, 37-P Circuit Avenue, Newton Highlands 61, Mass.

MACAO Flower set. 10c with approvals. Seminole Stamps, Box 1138-P, Coral Gables 34, Florida.

THREE Beautiful mint new issue sets free to serious collectors desiring good clean approvals, honest prices, prompt service. Wilvann Stamps, Box 472, Slatersville, R. I.

SEND For illustrated catalog! United States stamps, albums, supplies. Delaney, 44 Bromfield, Boston, Mass.

200 DIFFERENT Ships on stamps \$2.95. 100 different animals \$2.50. Supreme, 2205 So. Grand, Los Angeles 7, Calif.

300 CHINA \$1.00. 200 French Colonies \$1.00. All different. Reihing, 1217 Westwood, Toledo 7, Ohio.

SIX Colorful French Colonial large pictorial sets only 25c to adults requesting approvals. Firland Stamp Co., Box 493, Seattle 11, Washington.

FREE! Obsolete U.S. occupation set. To approval applicants only. Riedell, Greensburg, Penna.

25 DIFFERENT French Colonials 5c. Approvals. Weitz, Box 83F, Orange, N. J.

LOOK! Twenty beautiful foreign sets, \$1.00. 75 different U.S., 10c. Eisner or both, with approvals. Farmer, 4913 Rosewood, Los Angeles 4, Calif.

3000 DIFFERENT World wide \$4.00; 3000. \$9.25. Austria, 1000 mounted \$8.50. Hungary 1000 mounted \$5.25. Memel 100. \$6.75. Germany 1000. \$2.50. F&S, Box 367, Lindenhurst, New York.

100 STAMPS Free with bargain approvals. Guyton, Box 1276, Monroe, Louisiana.

1011 DIFFERENT Stamps 98c. Bargain lists. Approvals. Broad Stamp Company, Box 866, Lexington, Kentucky.

U.S. Approvals, mint, used! Square Deal Tea, 643 Beach, Rochester 12, N. Y.

100 DIFFERENT Worldwide 15c. Approvals. Bisland's, Box 1101P, Spokane 10, Wash.

SPECIAL! 1000 Varieties \$1.00. Approvals. Baird-Stamps, Box 8713, Portland 7, Oregon.

WONDERFUL Offer. 7 complete mint sets only 10c with approvals. Reich (M26), 1033 Lawrence, Chicago 40.

ALBUM! 32 Pages! Only 10c! Approvals. Hartford Stampmart, Hartford 1, Conn.

STALIN, Roosevelt giants, Intl. 40 others, 5c. Approvals. Blubonnet, 4509 Athens, Waco, Texas.

110 AMERICAS, British, many topicals 10c. Approvals. Bristol Stamps, Collinsville, Conn.

BORNEO Pictorial set 10c. Approvals. Hess, 65 Danforth, Jersey City 3, New Jersey.

U.S. Commemoratives, 33 different 10c. Approvals. White, 516 Avenue L, Brooklyn 30, N. Y.

GERMAN Airmails—20 different, 15c with approvals. Excello Stamp Company, Box 489, Red Bank, New Jersey.

REQUEST Approvals. Receive Lundy Island sheet free. Elmton Stamp Co., 960 Sixth Avenue, New York 1.

U.S. Illustrated price list free. Lush, 6422 Ellsworth, Detroit 38, Mich.

SHIPS, Planes, trains, plus 200 different foreign, 25c with approvals. Golden West Stamps, Box 245-M, Rivera, Calif.

PHILIPPINES—25 Different 10c with 1c, 2c approvals. Moffat's, 921 College, Rock Hill 13, South Carolina.

100 FOREIGN, 20 U.S. commemoratives, 10c with approvals. Weckerling, 608C South 6th, Baton, New Mexico.

TERRIFIC Collection, five continents, includes bicolors, triangles, flowers, animals, commemoratives, etc. for 10c with approvals. Richardson Stamp Co., Niagara-on-the-Lake 1, Ontario.

FREE—Valuable U. S. A. stamp! See our display ad on page 53 of this magazine. H. E. Harris & Co.

FREE! Dandy worldwide stamp collection for names, addresses two collectors, 3c postage! Tiptop, Box 30, Times Square Station, New York 36, N. Y.

CORONATIONS And triangle packet free with approvals. Gilbert, Box 883, Miami Beach 39, Florida.

CROATIA Flowers—Birds, triangles (12) given; approvals. William Deem, Ravenswood, West Virginia.

UNITED Nations cover free to applicants of U.S. or British Colonial approvals. A. Taylor, Skyland, N. C.

CANADA, 1953 Complete Queen Elizabeth set, coronation, 10c, same mint 25c. Attractive approvals. Rheaume, 6591 11th Ave., Montreal 36, Canada.

U.S. Commemoratives, 150 mixed 50c. Ray, 321 S. Cicero, Chicago 44.

ISRAEL Five stamps free with pictorial approvals at terrific discount prices. Kerry Stamps, 18229-A Gilchrist, Detroit 35, Mich.

MONACO Nudes complete 10c. Approvals. Royal Stamp Company, Tamaqua, Penna.

GIANT Collection! Over 200 different stamps including: Timor, Rhodesia, Mauritius, etc. Rushed, only 10c to approval applicants. Evden, Box 128, Valley Stream 35, N. Y.

BARGAINS Galore! Ask for "Stamps of Quality" price list today. Elholm's, 821 Hayes, Racine, Wisconsin.

WEST Indies, French Africa, over 100 others, only 10c! Approvals included. Cole, 43-A Rinewalt, Buffalo 21, N. Y.

WORLDWIDE, 50 All different, absolutely free, just to introduce our incomparable approvals. Kent Stamp Company, GPO Box 87, Brooklyn, N. Y.

FREE U.S. illustrated bargain catalogue. Rothberg's, 53 Bromfield, Boston 8, Mass.

TWO \$5.00 U. S. stamps plus 20 different, 10c with U. S. approvals. Irwin Stamp Co., Box 1105, Brooklyn 30, N. Y.

100 DIFFERENT U. S., 40c with U. S. approvals. Falth, 1339½ Westminster, Alhambra, California.

POLAR Bear triangle, giant George Washington, six colored Ecuador, Arctic triangle, first American commemorative, Corsica, Devils Island, others. Everything free with approvals. Capital Stamps, Little Rock 2, Ark.

ECONOMICAL ¼c-1c-2c-Approvals, 22,000 varieties available. Dresel, Box 270-n, New York 25, N. Y.

FABULOUS Collection—Roosevelt and dictator stamps. Mammoth fascinating collection of Roosevelt and dictators including Stalin, Tito, Franco, Lenin, Hitler and great many others plus free booklet and bargain lists. All for 10c with approvals. Jamestown Stamp, Jamestown, Dept. 413, N. Y.

50 DIFFERENT Bulgaria 10c! Approvals. Ensign Stamp Company, Dept. M, Berdan Avenue, Paterson 2, New Jersey.

NUDES Set: Colorful approvals 10c. Atlas, 2830-M, Eisenhower, Racine, Wis.

EXOTIC Oriental collection, 105 all different stamps from Borneo, Hong Kong, Malaya, Sarawak, Korea, Japan and many other strange countries of the Far East plus free booklet and bargain lists. All for only 10c to new approval customers. Jamestown Stamp Co., Jamestown, Dept. 313, N. Y.

90,000 STAMPS: Grabbag 40c. Big lot, better stamps, \$1. Extra special, \$2. Giant assortment, \$5. Perail, 436 New York Ave., Brooklyn 25, N. Y.

50 DIFF. U. S. commemoratives 25c. Mammoth packet list free. Econopackets, Box 168, Riverside 9, Calif.

329 DIFFERENT Worldwide stamps 25c including Hitler heads, British colonies, French colonies, rarities, unusuals. Everything complete 25c to adults requesting approvals. Canada Stamp Co., 1907 Main St., Dept. 118, Niagara Falls, N. Y.

UNITED States—58 different including 8 airmails, 15 commemoratives, 10c. Approvals. Sunset, Box 47, South Gate, Calif.

FREE—50 Different, with approvals. Fabsing, Dept. PM, Atascadero, California.

65 ALL Different U. S. stamps. Includes 50 year olds, commemoratives, airmails and \$5.00 stamp. Only 10c. Approvals. Willett Co., Box 511-L, Port Chester, New York.

225 STAMPS For only 10c! This mammoth value includes airmails, pictorials; stamps from strange countries cataloguing up to 25c each! Also approvals. Mystic Stamp Company, Camden 80, New York.

ANIMALS, Birds, triangles, flowers, butterflies, fish, ships, locomotives, kings, dictators, multicolored, historical, geographical, musical, battles, giants, midgets and over 100 others—only 25c with approvals. Adults please. Canada Stamp Co., 1907 Main St., Dept. 318, Niagara Falls, N. Y.

HANDSOME New Zealand 1943 Elizabeth and Margaret Rose triangles only 10c to approval applicants. George Richie, 1339 Sixth, Alameda, Calif.

WOW! 153 All different Germany, 10c. Zeppelins, semi-postals, airmails, high values, big bargain lists and approvals included. Jamestown Stamp, Jamestown 512, New York.

STAMPS Wanted. Mint and used, collections, accumulations. Good grades only. Buy outright if bargain. What have you? Write, give details. Vanroy Shirk, Lebanon, Penna.

TRIANGLES, Birds, butterflies, flowers—Big packet 10c with approvals. South-west Stamps, Box 117, Long Beach 1, Calif.

300 DIFFERENT Triangle, airmail, pictorials, etc. 25c. 500 mixed U. S. 25c. Carlton's, Tujunga, Calif.

200 DIFFERENT, including Roosevelt triangle, 10c to approval applicants. M. Avalon Stamp Company, Springfield, Mass.

327 DIFFERENT Stamps 25c! Including early Canada, Newfoundland, British Colonies, Vatican, Red Russia, Hitler heads, Indian states, animals, airmails, French Colonies, rarities, unusuals. Every stamp different. Rare bargain with approvals. Money back guarantee. Niagara Stamp Co., Niagara-on-the-Lake 81, Canada.

50 DIFFERENT Argentine 10c. Approvals. Reuter, 611 W. 40th Pl., Los Angeles 37.

FREE 119 Foreign stamps including Africa, Australia, Pakistan, China, India, Russia and Scandinavia. Send 10c for postage and handling. With approvals. Niagara Stamp Co., Niagara-on-the-Lake 81, Canada.

AMAZING Offer! 200 United States stamps—including commemoratives, airmails, high denominations to \$1.00. Only 10c to approval applicants! Illustrated bargain lists free. Mystic Stamp Co., Dept. 80, Camden, New York.

100 DIFFERENT Spain 25c. Penny approvals included. Reed, Box 980, Chicago 90, Ill.

OLD Scarce U.S. seconds on approvals. Slight imperfections, lowest prices. Hernefield, Clintonhill Sta., Newark 8, N. J.

WORLD'S Largest stamp (7½x14 inches). A real curiosity! Retail for 50c, only 3c to approval applicants. Tatham Stamp Co., Springfield 30, Mass.

SPEND Pennies! Not dollars! Thousands of fascinating stamps to choose from our 1c and 2c approvals. No premiums. Just honest value. Pat F. Knowles, Box 2347, Van Nuys, Calif.

OLD U.S. approvals. Low prices. MacG., 2905 Observatory, Cincinnati 8, Ohio.

COLOSSAL Stamp zoo free! Jungle beasts, wildlife, domestic animals—Fifteen different, including rhinoceros, elephant, snake, tiger, zebu, kangaroo, koalabear, emu, kookaburra, bull, horse. Extraordinary accompanying approvals. Send 10c for postage and handling. Niagara Stamp Co., Niagara-on-the-Lake 51, Canada.

50 DIFFERENT United States 5c with bargain approvals, lists. Bookman, Manatee 1, Florida.

FREE! 1954 Bargain lists. (Mint stamps of Europe and Africa.) Boger, 3401 Oakmont, Philadelphia 36, Penna.

FREE—105 Different British Colonies. Aiden to Zanzibar! High catalog; pictorials. Approvals. Send 10c for mailing. Kenmore, Milford 8T, N. H.

U.S. Mint 797 SPA sheet, 10c to U.S. approval applicants. M. Haycock, 153M 74th St., Brooklyn 9, N. Y.

ESTONIA Carrier pigeon set free to approval applicants. Canyon Stamps, Box 808, San Fernando, California.

25 MULTICOLORED Triangles, only 25c with beginner or advanced approvals. Low prices. Essex, 5946 Arlington, Los Angeles 43, Calif.

FREE Sample—Interesting, illustrated. National Stamp News, Anderson, 696, South Carolina.

U.S. 40 Different commemoratives 25c. No approvals. Seidenberg, Appleton 944, Wis.

FROM Tiny to Jumbo ones, Asia, 115 diff. 30c. (China, Hejaz, Israel, Japan, Manchukuo, Siam.) Robert Boger, 3401 Oakmont Ave., Philadelphia 36, Penna.

U. S. Mint specials! Flag set, \$1.00; national parks #740-49, \$1.50. Free price list. Brooks, 2352A East 23rd Street, Brooklyn 29, New York.

MEDITERRANEAN Bonanza—Ships, planes, bi-colorfuls, all pictorial, only 10c to approval applicants. Comanche, Box 7817, Lakewood, Colorado.

830 MIXED U.S. old-new 25c. Lists. Weatherly, Medina, Ohio.

BARGAINS Galore. Low priced approvals. Schur, Box 117, Williamsville 21, N. Y.

25 FRENCH Colonies 5c; approvals sent. Adler, 367-M Park Ave., Newark 7, New Jersey.

12,000 PENNY Approvals waiting for you. Many from exotic countries, pictorials, airmails, new issues. Tilbury, Box 862, Newark 1, N. J.

FIJI Bicolored health set, 5c. Approvals. Pleasure Stamps, 1865P—52nd, Brooklyn 4, N. Y.

96 PAGE Illustrated U. S. price list. Send 10c, cost of mailing. DeLisle, 69 Plaza Shopping Center, Fresno 1, Calif.

ANTIQUES, RELICS, INDIAN GOODS, CURIOS

UNITED States silver dollars, \$1.75 each, postpaid. Guaranteed genuine. Liberty head or Peace. Carry one as lucky pocketpiece. Fred Birch, Box 634, Deer Lodge, Montana.

DARK Africa genuine native handmade ivory, ebony carvings. Marvelous gift. Particulars 25 cent stamp. Vessiere, P.O.B. 2482, Leopoldville, Belgian Congo.

6 PERFECT Arrowheads \$1.00. List free. Charles Palmer, Rd 1, McKeesport, Penna.

ANTIQUE Firearms, swords, curios, il-lustrated catalog 35c. Westbrook, 738 Royal Street, New Orleans, Louisiana.

KQWUITschuerbellerscken: Am selling 600 historical firearms, 25,000 pre-historic Indian relics, 20,000 historical cartridges, 10,000 coins, mounted birds, deerheads, bayonets, frontiers, violinwood, Kentuckies, Agates, fossils, gold dollars. Profusely illustrated catalog 35c. Heike, Englerock, Wenona, Ill.

SEND Dollar for full color hand printed picture, Indian Dancer. Free list. Tewa Enterprises, 724 Canyon Road, Santa Fe, New Mexico.

6 GEM Arrowheads \$2.00. 4 fine arrowheads \$1.00. Notched tomahawk \$1.00. List free. Lear's, Glenwood, Arkansas.

4 SELECTED Arrowheads \$1.00. List 5c. H. Talburt, Calico Rock, Ark.

PRECIOUS STONES, MINERALS

FIND Tungsten, mercury, uranium with Mineralight. Free brochure. Write Dept. PM8, Ultra-Violet Products, South Pasadena, California.

5 RARE Minerals from Angelfalls area Venezuela \$5. First quality industrial diamonds 1/5 carat \$7.50. Apply for larger industrial and gem qualities and further information PO Box 2585. Payments only by cheque to Royal Bank of Canada Account Vanheyningen & Vandeputte, Consulting Geologists, Caracas, Venezuela.

TWO Gem ruby garnets, India 1/2", each \$1.00 prepaid. Eckert Mineral Research, Florence, Colorado.

JOIN The thousands whose hobby is gem cutting, jewelry making, mineral collecting. Send only \$3.00 today—for 12 monthly issues of national how-to-do-it magazine. Sample copy 25c. Gems & Minerals, Dept. A-10, Palmdale, California.

"GENUINE" Red Arizona rubies (garnets). Send quarter for packet. Bitner's, Box 1025B, Scottsdale, Arizona.

TEN New Mexico minerals \$1.50, six fluorescent \$1.00, fools gold 25c. Free literature. Minerals, Winston, New Mexico.

URANIUM, 1.00% U3 O8, \$1.00. Instantly determine ore value by comparison with this accurate sample. Uranium, 22319 Kathryn Ave., Torrance, Calif.

GEMCUTTING, Silvercraft authority. Illustrated magazine tells how. Cut rocks, make jewelry. 150 ads illustrating equipment, offering gems for collectors, cutters. Postal brings literature. Lapidary Journal, Drawer B, Palm Desert, Calif.

GEMSTONES, Mineral specimens. Every variety. Lowest prices. Free booklet. Plummer's, 4720 Point Loma Ave., San Diego 7, Calif.

SAPPHIRE, Topaz, tourmaline, garnet, peridot, 5 uncut gem specimens, \$1.00. O'Brien's, 1116M Wilcox, Hollywood 38, Calif.

AGATES, Jade, gems. Free list. North West Gems, 2819 North Warner, Tacoma 7, Washington.

HOBBIES AND COLLECTIONS

WANTED: Cigarette, tobacco cards. Write Charles Bray, East Bangor, Penna.

50 DIFFERENT Army embroidered patches \$1. Other bargains. Insignia Mart, 702A Broadway, New York 3, N. Y.

GENUINE Virginia fairystones. Collection, including legend, \$1.00. Virginian, Box 862, Inverness, Florida.

HOBBY Printers—Join non-profit American Amateur Press Association, 822 South Orleans, Tampa 6, Florida. Hobby papers exchanged.

FOREIGN Medals, clearance catalog 10c; 37 American different emblems \$1.00. Hobbyguld, 550B—5th Ave., New York.

VARIOUS Seashells from American, foreign shores. Big assortment \$3.00. Hobbyshells, 1133 S.W. 9th Rd., Gainesville, Fla.

UNUSED Matchbook covers, 100 differ-ent \$1.00. 36 page catalog 25c. Matchcover album \$3.00. Charles Edelman, 1311C East 84, Cleveland 3, Ohio.

NAZI Medals, Campaign ribbons, il-lustrated lists. Big packet, \$1.00. Medcrafts, 1923 34th St. S. W., Calgary 2, Canada.

NEW—15 Different match covers 10c. Box 202, Rochester 1, N. Y.

INVENTING Can be an interesting and profitable hobby. Write for complete particulars. Institute of American Inventors, Dept. 40-E 631-E St., N.W., Washington 4, D. C.

MILITARY Miniatures: U. S. Marines, American Revolution, Civil War, Custer's Cavalry. Illustrated catalog 25c. Bussler Miniatures, 59 Russell Park, Quincy 69, Mass. Dept. B.

WORLD'S Smallest Bible 50c. Three, \$1.00. Empires, Box 301, Amesbury 2, Mass.

ASSORTED Shells, Sea horse pack \$1. Box 716, Manhattan Beach, Calif.

CAMERAS, PHOTO SUPPLIES

OIL Coloring photographs—A fascinat-ing hobby or profitable sideline for those with artistic talent. Learn at home. Easy simplified method. Free booklet. National Photo Coloring School, 835 Diversey Parkway, Dept. 343C, Chicago 14.

BUY Wholesale—Photo equipment, appliances. Discounts to 45%. Free catalog. Camera Shoppe, Box 601-m2, Mount Vernon, N. Y.

20 TO 40% Discount. Everything photographic. Dart, 3812E Atlantic Avenue, Brooklyn 24, New York.

35 MM Slides, World War II, 100 as-sorted black and white. Only \$5. Abbe, 503 Fifth Ave., New York 17, N. Y.

BUY Wholesale nationally advertised cameras, photo supplies, thousands other products at big discount. Free "Wholesale Plan." American Buyers, 629-RR Linden, Buffalo 16, N. Y.

DARKROOM Plans, \$1. Industrial Photographic Technicians, Box 2601, University Station, Wichita 14, Kansas.

RANGE Finder lens assemblies, new, government cost \$200.00—\$9.95 while they last, prepaid. Check or money order with order. Coronet Enterprises, Box 364, Rochester, New York.

TRIPOD—Shirt pocket size tripod. Weight 4 oz. Fits all cameras. Money back guarantee, \$3.00 postpaid. Flite-Wate, 929 13th St., Bellingham, Wash.

AERIAL Cameras, K-21, less lens and filters, original government package, \$700.00 value for \$39.50; 3 for \$100.00. Operates automatic or manually. Shipping weight 60 lbs. Check or money order with order. Coronet Enterprises, Box 564, Rochester, New York.

BASS Says: Quality cameras since 1910. When in Chicago visit the camera cross roads of the world, or write us for your favorite equipment, new or used. Satisfaction guaranteed. Bass Camera Co., Dept. AG, 179 W. Madison St., Chicago 2, Ill.

PHOTOGRAPHY For pleasure or profit. Learn at home. Practical basic training. Long established school. Free booklet. American School of Photography, 835 Diversey Parkway, Dept. 3432, Chicago 14.

PHOTO FINISHING

TWO Beautiful prints from each picture on roll, 8 exposure 35c, 12 exposure 45c. Thirty-three years of satisfied customers. Quick service. Lens Photos, Dept. J-4, Janesville, Wis.

SENSATIONAL! 8 Jumbos, 25c; 12, 35c, 35mm.-36 exposure, \$1.00. Guaranteed quality. With this ad only. Flash-Photo, Box 36B, Brooklyn 4, N. Y.

PAST. Same day service! 8 oversized prints only 35c; 12-50c, 16-65c. Satisfaction guaranteed. This ad worth 10c toward first roll. Trial offer only! PicSure, Box 899-B, Philadelphia 5, Penna.

PROFESSIONAL Enlargements: Twenty 4x8s or ten 5x7s or five 8x10s \$1.00 from negatives or photo. Artshop, PM246, Sweetwater, Texas.

SPECIAL Offer—8 Jumbos 25c; 12, 35c. with this ad. Western Photo, PM104, Box 298, San Francisco 1, Calif.

THE Photo Mill. Immediate service. Eight exposure roll developed and one print each good negative 30c; two, 40c; one jumbo each 35c; two 65c. Write for complete prices and mailers. The Photo Mill, Dept. K, 1511 Hennepin, Minneapolis, Minn.

BIRTHDAY? Hand-colored 5 x 7 en-largement from negative or photograph \$1.00. State colors. Snapshot Photo Service, 311 Citizens, Aberdeen, South Dakota.

PHOTOS Copied, 20 wallet-size deluxe prints \$1.00. Original picture returned. Send any size photo or negative. Federal Wallet-Size Photo Co., Dept. PM-4, P.O. Box 2448, Kansas City 6, Mo. (No c.o.d.'s please.)

ROLL Developed and 16 prints 40c. Free mailers. Fast service. Mayfair Photos, Box 617-K, Toledo 1, Ohio.

BEAUTIFUL Enlargement from each picture on roll, 8 exposure 35c; 12 exposure 45c. Cut Rate Photos, Dept. B-4, Janesville, Wis.

GUARANTEED Quality. Fast service. Eight jumbos in beautiful super pak plastic ring binder albums only 35c. Send for free mailers and particulars of our complete photo finishing service. Grand Fotos, G.P.O. Box 1410, New York 1, N. Y.

TOP Quality. Fast service. 8 jumbos 35c in beautiful super pak album. 16 contacts 40c. Reprints—Jumbos 4c; contacts 3c. Satisfaction guaranteed. Write for free mailers and circulars. Fast-X-Photo, Box A, Jersey City, N. J.

6 OR 8 Picture roll 35c, 12 or 16 pic-ture roll 55c. Each roll developed and printed in handy album pack. Send coin with roll. No c.o.d.'s. Mailing containers sent free. Deluxe Film Service, Box 1268-A, Shreveport, Louisiana.

ENLARGEMENTS! Eight 5 x 7's or five 8 x 10's. \$1.00. Wilart Enlargers, Box 967, Little Rock, Ark.

8 JUMBO Prints in album 30c; 12 exp. 45c; 20 exp. 85c; 36 exp. \$1.25. Free mailer. Mel's Photo, Box 106F, Brooklyn 20, N. Y.

JUMBO Prints, 8 exposure roll 30; 12 exposure 45c; 16 exposure 55c; reprints jumbo 4c. Guaranteed quality since 1915. Mail order Photo Service, Box 297, Watertown, Wisconsin.

12 JUMBOS From any size roll developed 25c with this ad only. S. Skrudland, Lake Geneva, Wis.

MOTION PICTURES AND SOUND EQUIPMENT

EARN Up to \$15.00 daily with your movie projector! Metcalf, 10906 Glenroy, Chicago 43.

8MM-16MM sophisticated film features. Frank Trigili, 804-A Eighth Avenue, New York 19, N. Y.

NOW! H. bomb movie release. 8 mm, 16 mm. Kodachrome. Ideal Service, 4644-H Geary, San Francisco 18, California.

2 x 2 COLOR Slides on San Francisco's highlights, 8 different shots \$1.50, sample 35c. Ideal Service Supply, Dept. S, 4644 Geary Blvd., San Francisco 18, California.

FREE! Blackhawk's fall sale catalog new and used 16mm., 8mm. films, used 16mm. sound projectors, new 3"x3" color slides. Blackhawk Films, 1000 Eastin, Davenport, Iowa.

INTERESTING 16MM sound movies. Rare combat films, hundreds hard to find collectors subjects. Low bargain prices. Free list. Gaines, Box 114-PM, Skokie, Ill.

RENT 16MM. sound feature pictures—\$3.95, three days, including delivery, return postage. 25-minute short subject programs, \$2.49. Big catalog free. Eastin Pictures, 106 Eastin Bldg., Davenport, Iowa.

WILD Animal and bird films. Beautiful color and b. and w. 2" x 2" slides and 8mm or 16mm movies. Write for free literature. Wild Life Films, 5151AK Strohm Ave., North Hollywood, Calif.

TAPE Recorders, tapes, accessories. Unusual values. Dressner, Box 66M, Peter Stuyvesant Station, New York City 9.

5,000 8-16MM. Silent-sound films. International, 2120 Strauss, Brooklyn 12.

MOVIE Camera film: 8mm. roll \$1.50, 16mm. 100' \$3.00. Free processing. Better Films, 742 New Lots, Brooklyn, N. Y.

GUARANTEED Fresh 8mm. roll, magazine; 16mm. roll, magazine movie films. Color, b&w. Free catalog. ESO-R, 47th Holly, Kansas City 2, Missouri.

RECORDERS, Tapes, equipment. Lowest quotations. Boynton Studio, 10 Pennsylvania, Tuckahoe, N. Y.

MUSIC AND MUSICAL INSTRUMENTS

SWISS Music movements assorted tunes \$1.70. Helax, 218 West 72nd Street, New York City.

AMATEUR Songwriters! Top notch Broadway staff offers help and suggestions for improving your song or lyric. Send \$1.00 with each manuscript or recording. Amateur Songwriters Workshop, P.O. Box 359A, Times Sq. Station, New York 36, New York.

SWISS Musical movements. Finest. \$2.50. Spielman, 131 West 42nd, New York 36.

SONGPOEMS Wanted. Collaborate with recognized songwriter. Send poems. La Motta Songs, 14 Bogardus Place, New York 34, New York.

SONGS Or song poems needed for commercial recording. Quick action. Celebrated expert offers you free copy of "Secrets of Song Success." Honest deal designed to benefit all concerned. Mail songs or poems now. Rexright Music Co., Dept. A, 5617 Hollywood Blvd., Hollywood 28, Calif.

SONGWRITERS: Large recording company may record your song. National sales and promotion if selected. No charge for melodies. Send song material to Music Makers, Dept. E-2, Box 2507, Hollywood, California.

SONGWRITERS! Outstanding offer. Ray Hibbler, C-3, 6808 Oleander, Chicago 31, Illinois.

WANTED! Poems for musical settings. Send poems now! Songwriting Service, 2950 Division, Chicago 22.

WRITE Songs for pay! My new easy method reveals professional secrets of profitable songwriting. Free information. Meadowlark Music School, 300 Sumner Road, Colorado Springs, Colorado.

AFFILIATED Songwriters. Mutual cooperation. Collaboration. Many benefits. Publishing, Recording, \$2.00 year. Web, 133 W. 48, New York 36.

1954 ACCORDIONS—Wholesale. Free catalog. American Accordion Center, PM-8, 5329 Belmont, Chicago.

WANTED! Poems for musical settings. Write Songwriters' Service, Clifton, N. J.

ACCORDIONS, Wholesale to everyone. Save up to 60%. All national known brands. Free catalogue. Del Principe, 29 South Cicero, Chicago 44.

SONGPOEMS Wanted. Mail to: Tin Pan Alley, Inc., 1650 Broadway, New York 19, N. Y.

FREE Record of your song. Your words, my melody. Free information. Johnny Mack's Melody Mart, 1094 West 39th Street, Dept. A, Los Angeles 37.

SONGWRITERS! Protect your ideas! Hold all songs, poems! Write for safe correct procedure first! Song Service, Dept. P, 333 W. 56th St., New York 19, N. Y.

POPULAR Songs. How to write and sell them. Write for free booklet Successful Songwriting. Gateway Songs, Box 2470, Hollywood 28, Calif.

SONGWRITERS! Send poems, songs. Music Service, 243 West 72nd St., PM, New York 23.

WRITE Songs. Big money and reputation. Write for information. J. Gordon Pub. Co., 4700 South California Avenue, Chicago.

POEMS Wanted for musical setting. Send poems. Free examination. Five Star Music Masters, 630 Beacon Bldg., Boston, Mass.

POEMS Wanted for musical setting. Send poems. Free examination. Crown Music Company, 1476 Broadway, New York City 36.

RADIO AND TELEVISION

BUILD 15 Radios at home—Only \$19.95 complete. Learn radio construction, theory, trouble-shooting, code, F.C.C. regulations. Complete radio course includes all parts, components, instruction books, etc. Free radio tester and soldering iron. You keep everything. No experience required. Money-back guarantee. Order direct or send for descriptive literature. Valuable radio and TV guide upon request, free of charge, no obligation. Progressive Edu-Kits Inc., 497 Union Ave., Dept. PM22, Brooklyn 11, N. Y.

FREE 308 Page 1955 television-radio-electronics catalog! World's largest stocks, lowest prices. Complete supplies for builders, experimenters, amateurs, servicemen. Latest builders' kits, TV, Hi-Fi, phonos, records, P.A. Thousands of parts, tubes, test instruments, books, diagrams. Top quality money-saving values. Get your copy now! Allied Radio Corp., 100 N. Western Ave., Dept. 34-K-4, Chicago 80, Ill.

REPAIR Your own TV or radio. Send make, model number, \$2.00. Limited offer. LJ Associates, 742 Snyder Ave., Philadelphia, Penna.

RADIO Tubes, all types. Guaranteed, also test kits, vacuum tube voltmeter. \$27.28. H. V. probe kit \$7.33. Ideal Service, 4644 Geary Blvd., San Francisco 18, Calif.

REPAIR Your own TV. Instructions compiled exclusively for your set. Simple as replacing light bulb. Send set name, chassis, model number, \$1.95. LS Engineering, Box 4113-J, North Hollywood, California.

TV Indoor antenna. Sensation. Dealers wanted. Send \$1 for sample. Dynalec, Box 2502, Denver.

INSTRUCTIONS, How to repair radios \$1.00. Slate's Radio Service, Corsicana, Texas.

F.C.C. Operator license quickly. Dept.-6, 6064 Hollywood Blvd., Hollywood 28, Calif.

FREE List. Builder's pictorial construction plans. Alena, 286 East Broadway, New York 2.

TELEVISION Antennas for pennies, from television lead wire. Popular "sneak antenna." Instructions \$1.00. Leonard, 729 East 10 Street, Brooklyn, N. Y.

FACTORY Authorized servicing diagrams and data for your TV receiver! Any make, any model, any year from 1946! 48-hour service! Just tell us the make and model! Only 70c for all the facts! Electronics Research Publishing Co., 480 Canal Street, New York 13.

24 PAGE Plans "18 Long Distance Crystal Sets" 25c, including "Radiobuilder," catalog, Laboratories, 328-C Fuller, Redwood City, California.

RADIO Diagrams \$1.00, television \$2.00. Give make, model. Diagram Service, 672-PM, Hartford 1, Conn.

TELEVISION Picture tube rejuvenator. Fits all makes picture tubes. Completely automatic. Easily installed. No tools needed. A.C. parallel circuits. Refund guaranteed. Special \$3.00 postpaid. Cash or money order. Stanley Distributors, 152 Franklin St., Elizabeth, N. J.

BUILD Your own top quality TV set. We supply complete equipment, tools, instructions as part of America's finest home-study TV course. Be a high-paid TV technician. Install, repair, service all makes of sets. Many excellent jobs now open. Or start your own business. Get full facts free. Write: Commercial Trades Institute, Dept. CT2-10, 1400 Greenleaf Ave., Chicago 26, Illinois.

TERRIFIC! Attach Zingo 3 color television screen to your set. Enjoy color now. Send \$1 for size 10", 12", or 14"; \$1.25, 17"; \$1.50, 20"; \$2, 21"; \$2.50, 24"; \$3, 27". Satisfaction guaranteed. Inquiries from dealers also welcomed. Zingo Products, Johnstown 77, New York.

MAKE Simple, tubeless, batteryless, distance-getting radio. Genuine Melomite crystal, detector, illustrated instructions. 50c postpaid. Allen, 427-PM5, Clinton, Mo.

CRYSTAL Radio experimenters. Write Leslie Hulet, R4, Lakewood, New Jersey.

RADIO One tube kit. Parts, tube, phone, batteries, instructions, nothing else to buy, \$7.95. Less phone and batteries, \$4.95. Crystal radio kit \$1.50; preassembled \$1.75. Crystal radio plans and germanium diode, \$1.00. Plans and Clearco detector, 50c. Free catalogue. Clearco Crystal Company, Box 1857, Milwaukee, Wis.

WHOLESALE Parts flyer free. Wholesale Electronics, 673 Elton Avenue, New York City 51.

BUSINESS OPPORTUNITIES

GARDEN Golf. Fascinating entertainment. Popular international sport. Profitable business. S. Brockway, Seaside, Ore.

NEW Company would like to start you earning money by raising mushrooms. Easy to do it anywhere, cellar, shed, garage. Send to: The Mushroom Lab, P.O. Box 226, Lawrence, Mass.

START Home manufacturing business. Make cleaners, soaps, polishes, cosmetics. Free literature. Kemix, Park Ridge, Ill.

THROWN Away! Tons recapper's buffed rubber. Make into plastic rubber, flexible molds. 1000 uses! Profitable! All materials available locally. Samples, information free. Ceeten Products, 506-B, Cornelia, Ga.

TYPE For pay, 25 ways. Write McAllister, 1513-PM-10 Charlotte, New York 60, N. Y.

BUILD Amazing home business supplying multi vitamin-mineral tablets. Whirlwind seller. Great repeater. Profits tremendous. Everything furnished. Free facts. Vitine Company, 208-CK Pacific Building, Miami 32, Florida.

START Home mailorder. Details. Gimbert, 1454 West Washington, Petersburg, Virginia.

\$26,500 SALES in two weeks! Amazing radio-mail order method. Free details. Broadcast Service, 1412-OP Great Northern Building, Chicago 4, Illinois.

MAKE Perfumes, other profitable products. Carelabs, 1914-PM Chouteau, St. Louis 3, Missouri.

WHOLESALE! Hundreds nationally advertised appliances, cameras, toys, kitchenware. Country's lowest prices. Large catalog 10c. Schibani, 1402 North 21st, Birmingham 4, Alabama.

MAKE Rhinestone jewelry. Send \$1.50 for pin and earring kit. Retail value \$3.50. Free catalog. Ebert, Box P183, East Orange, New Jersey.

START Own business, local mail order, folders describes 137 money-making plans free. Ferguson Publishing Company, 324 W. Maple Road, Box 102, Indianapolis 8, Indiana.

OPERATE "Escalator" mailorder system, selling our products or any products. Write: Selbyco, Decatur 161, Illinois.

FOOD Mailorder business. Home operated. Everything supplied. Successful proven method. Free sample, details. Frasar Foods, Desert Springs 11, Calif.

START In mailorder without capital for merchandise and advertising. Information free. Morris Colson, 406 E. Fox St., South Bend 14, Ind.

MEXICO Imports—Mail order business, sparetime. Romantic, profitable. Dime brings particulars. Frontier Imports, 2909 Pershing, El Paso, Texas.

OPERATE Profitable mail order business. Splendid opportunity. For details write, S.M.C. Mailing system, P.O. Box 94, Lamoni, Iowa.

START Own business. Booklet describing "301 Business Plans" free. Shalack, Box 869 P.M., Grand Central Station, New York 17, N. Y.

MAIL Letters from your home—Get \$5-\$10 orders in every mail. Keep half. A. Dadson, 8523 Baker, Houston 17, Texas.

"WHICH Home Business for Me?" guides your choice, profitable development. New, 25c. Farr, Garnerville, N. Y.

AN Important message for you! Is extra money important to you? Would you invest 4 days a week for \$200? Many other smart people are cashing in big in this lucrative repeat business. Captain Payne's booklet reveals hitherto little known secrets of making big money from the products of the sea. Business flourishes in depression, booms in good times, you can't miss. Payne's plan good in both coastal and inland states. Start your own business. Be your own boss. Act now. Send \$2 for booklet to Capt. Fred Payne, P.O. Box 73, Medford, N. Y.

OPERATE Profitable mail order business. Selling cartooning courses. Write Templeton, 1210 Riverview Court, Columbus 1, Ohio.

SHINE Cars without "polish." New invention. Lightning seller. Cars gleam like mirror. Samples sent on trial. Kristee 105, Akron, Ohio.

START A buying service, buy wholesale thousands nationally advertised products. Make big profits selling at sizable discounts. Postcard brings details. American Buyers, 627-R Linden, Buffalo, N. Y.

FREE Kit puts you in business selling world's famous French-type perfumes. Reproductions costly fragrances. Individually gold boxed \$1 sellers. Costs you \$3 dozen. You make \$9. Mammoth treasure royal box, 3 thrilling fragrances in one fabulous gold box. \$3 sellers. Costs you \$6 dozen. You make \$30. No experience needed. Pull or part time. "Husk" O'Hare, 5732 North Kenmore, Chicago 40, Illinois.

BE Your own boss, 301 plans, free details. Sam Smith, 525 Auditorium, Daytona Beach, Florida.

START Your own business on credit. Your own boss. 1661 of our dealers sold \$5,000 to \$28,500 in 1953. We supply stocks, equipment on credit. 200 home necessities. Sales experience unnecessary. Pleasant profitable business backed by world-wide industry. Write Rawleigh's, Dept. J-U-P.M., Freeport, Ill.

DO Your own printing. Save money. Make money. Print stationery, cards, envelopes, profitable advertising work, etc., with world's lowest priced professional printing press! Everyone needs printing—now you can do it easily, and make money. We show you how. Complete outfit only \$27.95. Send \$5c for illustrated manual "How To Print" and free details. Wellington Organization, Dept. 10-W, 953 West Belmont Avenue, Chicago 14, Illinois.

IMPORT-Export: Opportunity, profitable, world-wide, mail-order business from home, without capital; or travel abroad. Established world trader ships instructions for no-risk examination. Experience unnecessary. Free details. Mellinger A70A, Los Angeles 24.

TRADE Magazines. See late copies through our easy to get acquainted service. Choose from 4,387, covering all fields. Current list free. Commercial Engraving Publishing Company, 34C North Ritter, Indianapolis 19, Indiana.

IMPORT-Export mailorder opportunities! Details. Warner, Box 6, Fort Scott, Kansas.

NEWEST Spare, full-time home business. \$5 to \$10 hour possible. Paint with suede—The finish with touch and eye appeal. Beautify auto dashboards, signs, radios, toys, figurines, lamps—1001 others. Complete, step-by-step instructions sent for no-risk examination. Free details. Coast, 1004-MZ So. Los Angeles St., Los Angeles 15.

COMMISSION Circulars—Offering real merchandise. Send for samples and details. Products, Box 23, Boston 17, Mass.

OWN Your own profitable buying service! Buy wholesale 10,000 nationally advertised appliances, homewares, jewelry, sporting goods, toys. Save yourself 66 2/3%! Unlimited profits selling others at discount! Free details. National Buyers Service, Box 426EA, Oakland, California.

MEN Wanted—Build luggage and cases at home. We sell your products, supply complete instructions, materials, everything. No special equipment needed. Free details. Cascraft, 805-G10 Sunset, Los Angeles 12, Calif.

COST Of things going up faster than your income? You can make more full or part time as a Rawleigh dealer. Write for full particulars. Rawleigh's, Dept. J-RR-P.M., Freeport, Ill.

BUY Wholesale! Save up to 80% on nationally advertised merchandise. Free information on any product. Catalog \$1.00, refundable. Nina Skidmore, 121 Pine, Elizabethton, Tenn.

FREE! "301 Profitable Small Businesses!" Amazing shoestring plans! Work home! Start sparetime! Deumant Surveys, Kenmore 23-R, N. Y.

GET Money by mail. Details free. Succeed, P. O. Box 962, Portland 7, Oregon.

POPCORN And potato chip equipment. Eakins, Box 933-A, Springfield, Ohio.

MERCHANTS Motorized displays easily made your shop. Write: Display Motors, 139 E. Second, Reno, Nevada.

MAKE Perfumes, other products. Sell mailorder. Formula catalogue free. International, 6347 Parnell PM-10, Chicago 21, Illinois.

MAKE Extra money between now and Christmas. Sell subscriptions to all popular magazines. Liberal commissions. For supplies write DeSales Magazine Service, 60 East 42nd St., New York 17, N. Y.

AUTO Wrecking and used parts selling can bring you surprising profits. Start anywhere as a side line with very small investment. 52 page booklet tells how to locate, disassemble and sell. The entire business planned. Plain and practical. \$2.00. Harry F. Tyler, P.O. Box 22, Severna Park 7, Maryland.

BECOME A game warden, or join forestry, park, lookout, wildlife conservation services. Enjoy outdoor work, good pay, real security. Complete information free! Write Home-Study Institute, 3156OR West Eighth, Los Angeles 5, California.

WOOD Toy wheels. \$1.00 brings 8 finely machined samples. E. L. Overstreet, Route 3, Box 243-A, Lufkin, Texas.

SELL Popular Mechanics and all other magazine subscriptions. Free catalog, supplies. Subscription Service Company, Dept. A, P.O. Box 2070, Birmingham, Alabama.

ADVERTISING Book matches—Cash in on big demand; sell union label matches. Cuts for all businesses and political parties. Free powerhouse selling kit, low prices, protection guaranteed on repeat orders. Cash commissions. Superior Match Co., Dept. MX-1054, 7530 Greenwood, Chicago.

LEARN Sewing machine repair, electrify, trade, sell. How to make big money at home sparetime. New zigzag machines, parts, etc., wholesale. Free details. Taylor Service, Hamilton PM-10, Ohio.

BIG Profits owning your own wholesale merchandising business. No investment! America's greatest wholesale appliance, homewares, jewelry, sporting goods catalog in color with your own name. We drop ship. Free brochure. General Wholesalers, Box 1195EG, Chicago; Box 3038EG, San Francisco.

WHOLESALE Catalog! 30-80% discounts! Nationally advertised appliances, gifts, watches, cameras, tools, etc. Start your own fully self-operating mail order business without capital! No experience necessary. Wholesale starting kits furnished. Outline of unique automatic sales plan included. Consolidated Distributors, Division 119, 21 Lafayette, Paterson 15, New Jersey.

MINIATURE Trees! Why pay \$2.00-\$10.00 for growing secrets? Free details. Tiny Trees, 5038 N. Winthrop, Chicago 40.

PART Time or full time. Your own business, selling name brands. No inventory required. Manhattan-W, 225 W. 57 St., New York City.

\$1,000 MONTHLY Possible in collection agency business. Free details. Write Cole Associates, Syracuse 2, N. Y.

\$10 DAY Sparetime mailorder. Costs nothing to try. White, 2615 Willo, Costa Mesa 4, Calif.

WANTED! Home producers, by manufacturers in our clearing house service. Become subcontractor, casting plastic products for these companies. Thousands of easy-to-make items required for consumer-industrial use. Cash in at home, without previous experience. Plastic Service Associates, Dept. 10-PM, East Boston 28, Mass.

GROW Orchids at home—Profitable, fascinating. Year 'round, Maine to California. No greenhouse. Gorgeous cattleyas, cymbidiums, etc. Successful home grower shows you how. Full details free. Flowerland, 4622-PG Wilshire, Los Angeles 5.

START Your own rubber stamp business. Hundreds of customers in your own neighborhood. It's easy, we show you how. Turn spare time into money. Write for free details. Wellington Organization, Dept. 10-P, 953 West Belmont, Chicago 14, Ill.

MAKE Money by mail. 12 big issues 25c. Luft's Advertiser, Hermansville, Michigan.

BRONZE Baby shoe mountings, beautiful designs, all-metal ashtrays, bookends, picture frames, \$2.25 each. Free literature. Bronzecraft Mountings, Greenville Station, Jersey City, New Jersey.

ARE You starting a business? Do you need help? Avoid costly pitfalls. Write Marchner Business Service, 2033 East Main St., Rochester 9, N. Y.

CHRISTMAS Trees bring big profits. Complete "know-how" 25c. Timberline, Box 332, Glens Falls, New York.

DOLLARS In personalized baby record books. Sell by mail. Eleven thousand new prospects daily. Use same literature we do. No-Co-Ro, Oakland 6, California.

MAKE All purpose proven best stucco and masonry paint, big profits. Free information. Larstane, 3419-9 East, Salt Lake City 6, Utah.

FOR Big money, learn sewing machine repair. Guaranteed plans, assures success. Write Purdy's, Box 207, Weatherford, Texas.

LEARN Real estate business for highly profitable lifetime career. Study at home. Newer, quicker, better method. Diploma awarded. Surprisingly low cost. Free literature. Seavy Realty Institute, 1750-B Colorado Blvd., Los Angeles 41, California.

GET Pair of Chinchillas at half price. Also 1000% profit plan. H. N. Jennings, 211 Roby Ave., East Syracuse, N. Y.

EXTRA Money!—Typing. 9-plans one dollar. Home Enterprises, 817-B Park S.W., Canton, Ohio.

START Your own business! Small investment. Terrific profits selling vitamins. National Health, 83 Barclay St., New York 7.

FREE Folio "45,000 Unlimited Vacations Plan." No canvassing, mailorder, merchandise, equipment. Unknown. Works itself—home! Haylings, Carlsbad, Calif.

FRANCHISES Make amazing profits! Exclusive distributorships, dealerships, agencies available. Fascinating, nationwide opportunities. Information rushed. National Franchise Reports, 920 North Michigan Avenue, Chicago 11, Illinois.

\$500,000.00 LIFETIME Earnings? Digitized administrative profession. Immediate income—Easy! Inspirational booklet: Auditax, 34651AA, Los Angeles 34.

YOUR Own profitable home mail order business. Small investment starts you. Free details. C. D. Crider, P.O. Box 156, Delhi, La.

HOME Business pays amazing profits. \$40.00 daily possible, sharpening circular saws. No experience needed. Jobs in your own neighborhood. Free book tells how. Belsaw, 34A Field Bldg., Kansas City 11, Mo.

MAKE Attractive building plastic, easily. Build and repair better for half. Bays Laboratories, Oklahoma City 9.

MONEY For your spare time. Agents needed for leading national magazines. Liberal commissions. Write ATSA, 3132 M St. N.W., Washington 7, D. C.

MONEY, Typing—sewing! Details free. Edwards, 3915-PM, 12th, Des Moines 13, Iowa.

EARN \$2.00 Hour! I do, making sandals. Youngs, 1308-PM, South First, Arcadia, California.

FREE Details. Profitable home mail-order business. Everything supplied. Holly's, Box 439, Jacksonville, N. C.

FREE Details name brands wholesale. Triple J Industries, 132 Berkshire, Bridgeport 8, Conn.

MAIL Order. Details free. Lexington Mail Service, 5511 Monroe, Chicago 44.

BUY Wholesale 450,000 products. Literature free. Carter, Box 6011-L, Chicago 80.

OWN A profitable home business. Free brochure on practical plans. Lorimer's, Box 2429, Greensboro, N. C.

FREE Literature, cedar, walnut magazine racks, unpainted figurines, Boyd's, Galena, Missouri.

TIN-Cans. Turn them into cash. Nine methods. Instructions 50c. Charles Company, 12-DCF, Norwood, Ohio.

OWN Operate route wishing wells. Place these new \$8.50 skill games on counters in cafes, luncheonettes, clubs, etc. Collect coins weekly. Write, Legalsharr, Box 929, Long Beach 1, California.

START Venetian blind laundry—machine patented. Inventor, world's largest manufacturer explains how. Free booklet. Jet Company, 522 N. Rural, Indianapolis 1, Indiana.

SELL! Buy! Trade! Anything. In "Trading Post Magazine." Sample 20c. Details free. Thorne's, 525 Dewey, Jackson 15, Michigan.

\$5,000.00 WORKING Ninety days! Become tax consultant. Auditax, 34651CA, Los Angeles 34.

MAKE Flexible molds. Cast figurines, plaques. Free sample. Tooker, 630-R Chestnut, Hamilton, Ohio.

AMAZING Home business plans. Write. Falcon House, Winnebago 2, Illinois.

MAKE Perfume, 39 formulas \$1.00. Billows, 110-65 37 Ave., Corona 68, N. Y.

FORTUNES Made raising crickets and fishworms. Guaranteed raising and marketing instructions, \$1.00. Carter Farms, Plains, Georgia.

NEW-Different home business opportunity! Address-mail literature featuring real merchandise. Everything furnished. Mills, 1752-A, Garden Ave., Lorain, Ohio.

GET \$10.00 Orders by mail! 100% profit! Everything furnished. Terrill, Bogard, Mo.

EXPORT Business easy made! Substantial income from home. No merchandise buying. Full setup service includes everything. Hermes Exports, 152 West 42, New York 18.

METALIZE Baby shoes, jewelry, gifts. Bronze, gold, silver. Free bulletin. Kiktavi, 7217-PY South Broadway, Los Angeles 3.

HAVE Home business mailing postcards offering real merchandise. Big earnings. Write: Mednis, 10 Port Norfolk, Boston 22, Massachusetts.

NATURAL Molding rubber, extra thick. Free sample. Flock, W. Wooley, 115-A Donald, Peoria, Ill.

LIQUID Rubber, make flexible molds. Free sample. Chaney, 1130 E. 16th St., Jacksonville 6, Fla.

MAKE Rubber stamps, repair dolls; learn silk screen printing. Catalogue (60 ideas) free. Universal, Box 1076-A, Peoria, Ill.

MAILORDER—Operate profitable home business using free advertising method. Revealing information free. Seidel, 7078-HF Hollywood, Los Angeles 28.

\$900 A Year sparetime sharpening saws at home. No selling. Hardware stores get saws on commission basis. Free booklet tells how. Victor Foley Company, Columbia Heights, Minnesota.

OVER 700% Profit making finished photos in 2 minutes on the spot in daylight without darkroom. No experience needed. Simple directions teach you quickly. Write P D Q Camera Co., 1161 N. Cleveland Ave., Dept. FM, Chicago 10, Illinois.

ELECTROPLATE Auto parts, novelties, mirrors, baby shoes. Easy, inexpensive home processes. Free booklet. Tyco Metals, Box 13231-MM, Houston 19, Texas.

BOOKKEEPERS. Keep books, small firms spare time. Manual latest technique by C.P.A., \$3.00. Modern Business, Box 466, Youngstown 1, Ohio.

MAKE Money at home—Mail cards, circulars feature real merchandise. Everything furnished. Big earnings. Philip's, Box 3-P, Boston 22, Mass.

RECAST Old batteries into new. Latest achievements. Battery Laboratories, Minneapolis.

START Venetian blind laundry. Profitable lifetime business. New machine. Free booklet. F. C. Co., 442 N. Seneca, Wichita 12, Kansas.

WHOLESALE Of sensational nationally advertised appliances, silverware, watches, cameras, etc. Start your own business. Full details. Send 50c for catalogue. International Sales Co., 175 Fifth Ave., New York 10, N. Y.

HOW And where to obtain capital. Particulars free. Star Service, Wapakoneta, Ohio.

TO \$40.00 Weekly. Sparetime, home operated mailorder business. Successful beginner's plan. Everything supplied. Lynn, 10420-M National, Los Angeles 34, Calif.

COPUBLISH Mail Sale Advertiser, leading mail order paper. Details, latest copy, dime. Vanroy Shirk, Lebanon, Penna.

EARN Money at home! Homemaker Magazine tells how. Sample, 25c. Sizemore, Box 7, 4917 Kostner, Chicago 36.

SCHEMER Magazine, Canfield 1, Ohio, monthly mailorder ideas, plans. Year \$1.00. Sample 20c.

PLASTERCRAFT Molds, liquid rubber, plasters, blocks, candle supplies. Catalog and manual free. Blue Rapids Supply, Blue Rapids, Kansas.

BUY It wholesale! Manufacturers, distributors offer \$50,000 items. Literature free. Olsen, 1231-A East Third St., Duluth 5, Minn.

GROW Mushrooms. Cellar, shed, and outdoors. Spare, full time, year round. We pay \$3.50 lb. We paid Babbit \$4,165.00 in few weeks. Free book. Washington Mushroom Ind., Dept. 172, 2954 Admiral Way, Seattle, Washington.

\$46 FROM Square foot plywood; jig saw necessary. Write: Woodarts, Bridgewater, Mass.

\$25 WEEKLY Working two hours daily at home. Lycke, Box 3471-A, Cleveland 12, Ohio.

BREED Rare tropical fish at home. Earn big money! Learn secrets! Help fill huge demand. Amazing opportunity! Free plan. Tropicals, 1008-P Los Angeles St., Los Angeles 15.

INCOME From local information. No selling. Write Neherco, La Verne, Calif.

RESILVERING Mirrors, formula 50c; two-way lookout mirrors, (No one sees you), 50c; coppered mirrors, 50c. All \$1.00. Nelko-Mir, Box 3462-J, Chicago 64.

LIVING Miniature ("Ming") trees only 10 to 20 inches tall. Grow at home. Big profits! Spare time opportunity. Fascinating! Amazing! Write for free seed and plan. National Nursery, Dept. PC, Inglewood 4, California.

MAKE Money spare or full time, casting metal toys and novelties. Big wholesale and chain store demand for autos, soldiers, ashtrays, banks, etc., keeps manufacturers busy. Production moulds furnished for up to 100 and more castings per hour. No experience or special place necessary. Write for information and illustrations of patterns needed. Metal Cast Products Co., Dept. A, 1696 Boston Road, New York 60, N. Y.

OPERATE Profitable mail order business. Write Walter Service, 4159-A East 112th, Cleveland 5, Ohio.

GOOD Paying business silvering mirrors, plating autoparts, reflectors, bicycles, bathroom fixtures, etc., by late method. No tanks or shop required. Outfit furnished. Free booklet. Gunmetal Co., Ave. H, Decatur, Illinois.

MINK Raising information free. Complete. Lake Superior Mink Farm, Superior, EEL, Wisconsin.

COLORGLAZED Concrete pottery made without molds. Patented method. Cemetery products, novelties, tiles. Basement leak-sealing. Money-making projects. Booklet, details free. Men only. National Potteries Company, Grand Rapids, Minnesota.

FREE Book "505 Odd, Successful Businesses." Work home. Expect something odd! Pacific, Oceanside, Calif.

FIX Typewriters. Free booklet describes our modern, inexpensive home-study course. Factory methods taught. Write Typewriter, Building 1, Tarentum, Penna.

MONEY In new greaseless doughnuts. Start in kitchen. No smoke. Sell stores. Free recipes. M. Ray Company, 3605 South 15th Ave., Minneapolis 7, Minn.

BRONZED Baby shoe supplies, instructions, mountings. Metal bookends, \$1.50 pair. Free catalog. National Bronze Supply, Box 56, Los Angeles 32, Calif.

MAILORDER Home business! Details stamp. Shirley, 20-Raspeburg, Baltimore 6, Maryland.

MILLION Articles wholesale. Supply source directory 10c. Idealer, Park Ridge, Illinois.

SELL Books, merchandise by mail. Good profits. We furnish circulars, names—Ship your orders. National, Box 88, Dorchester, 220, Mass.

MONEYMAKING Mailorder business plan. Free! Write, George Lenhoff, Lincoln 8, Nebraska.

BOOKKEEPERS. Increase earnings operating sensational bookkeeping service. Kern, 4942 Vineland, North Hollywood, California.

MAKE Money at home as renewal headquarters for all magazines. Big Christmas sales profits now. Liberal commissions. Supplies furnished. Write for free catalog. McGregor Magazine Agency, Dept. 5005, Mount Morris, Ill.

VENDING Machines—No selling. Operate a route of coin machines and earn amazing profits. 32-page catalog free. Parkway Machine Corporation, Dept. 72, 715 Ensor St., Baltimore 2, Md.

SELL By mail! "How to Build Your Own Mail Order Business" tells how. Satisfaction guaranteed. Only 25c. Fred La Roche, Merritt Island 3, Florida.

ANSWER Advertisements easier! 500 name-address labels \$1.00 postpaid. Miles Crafts, 3220-P Fish Avenue, New York 69.

LOWER Priced metal baby shoe mountings. Posters, 1520 Ardmore, Chicago 26.

BOOKLET "Your Business at Home," \$1.00. Home Industries Association, Dept. PS, 1727 K Street N. W., Washington 6, D. C.

NEW Exceptionally profitable plans, ideas for home operated mail business. Rush name. Miller, 1772-P Carlyon Road, East Cleveland 12, Ohio.

OPERATE Your own mail order business! Start right! Avoid costly mistakes! "Mail Order Business Manual" shows you how! Price \$1.00. Bud E. Hine, Box 93, Battle Creek, Michigan.

BRONZE Baby shoes. Instructions, equipment and mountings for genuine electroplated process. Free catalog. Hollywood Bronze Supply, Dept. B-3, 1634 East First Street, Los Angeles 33, Calif.

LEARN Exterminating formulas, secrets, charges. Manual tells all. \$1.00 postpaid. Knox, 1208 Walnut, Philadelphia 7.

RAISE Earthworms! Terrific! Get essential information plus story, "An Earthworm Turned His Life." Send dime. Earthmaster System, 8H, El Monte, Calif. Hurry!

EARN \$2.50 To \$6.00 per hour plating auto parts, baby shoes, etc. Part or full time. Free information, trade secrets. Plater B. Hyde, 327 West 120th Street, Los Angeles 61, California.

FLEXIBLE Rubber molds for plaster and Marble figurines. Sample and large illustrated catalogue 25c, refunded on first order. K-C Novelties, Dept. 74, Easthampton, Mass.

UNUSUAL Mail order ideas, sources. Details free. Fax, Box 241, Brownwood, Texas.

MAKE Big money at home! Invisible re-weaving pays up to \$10.00 profit in an hour. Make tears, holes disappear from fabrics. Constant demand from laundries, cleaners, homes, brings steady earnings. Details free. Fabricon, Dept. AE, 8342 S. Prairie, Chicago 19, Illinois.

MONEYMAKING OPPORTUNITIES

I can teach you how to direct money-raising campaigns for churches, hospitals, institutions. Earned \$3065 in six weeks on my first campaign. Started spare time on less than \$50. Thirty years experience in 15 lessons. Low cost. Unlimited field. William Arbogast, 229 East Mason Avenue, Alexandria, Virginia.

PRINTING And office supplies wholesale, 20,000 items. Literature free. Royal, Box 368-A, Cleveland 27, Ohio.

GIANT Wholesale catalog, nationally advertised merchandise \$1.00, refundable. Speedway, 2320 N. Raynor, Joliet, Ill.

NEW 7"x11" Ultra-blue signs. 7c, retail 50c. Sample free! Lowy, 812 Broadway, Dept. 816, New York 3.

FREE! "301 Profitable Small Businesses!" Amazing shoestring plans! Work home! Start sparetime. Deumant Surveys, Kenmore 23-R, N. Y.

INCREASE Your income, turn your spare time into cash—Making quick-selling, highly profitable lamps and fiber glass shades. Every home a prospect for one or more. Hundreds already doing it, so can you. No experience needed. No special tools required. Gearon's big, new 72 page 1954 illustrated Catalog No. 8 will show you how, quickly. One special 8-page section shows 6 beautiful lamps in kit form, ready for you to assemble. Another 12-page section shows you how to make stunning, ultra-modern fiber glass shades. Page after page filled with wide variety of other attractive shades, shade frames, figurines, and lamp bases. Also oil lamp converters, boring compound, and all kinds of cords, sockets, pipes, harps, finials, bases, and hundreds of other parts. Everything you need. And you can buy everything wholesale, sell at retail, make big profits, fast. Send only 25c right now for Gearon's big 1954 catalog and wholesale price list. Like hundreds of others, you'll be glad you did. Gearon Co., Dept. 503-B10, 27 S. Desplaines, Chicago 6, Ill.

LEARN Technical Metaphysics and insure your future. Easy, inexpensive correspondence course. Simplest method known. Diploma. Write: Premier College of Technical Metaphysics, 2532 McKenzie St., Vancouver, B. C., Canada.

EARN More money at home. Age no handicap. Easy. Hoffmann, 880 Glen, San Leandro, Calif.

START A buying service, buy wholesale thousands nationally advertised products. Make big profits selling at sizable discounts. Postcard brings details. American Buyers, 630-R, Linden, Buffalo, N. Y.

WHOLESALE Catalog! 30-80% discounts! Nationally advertised appliances, gifts, watches, cameras, tools, etc. Start your own fully self-operating mail order business without capital! No experience necessary. Wholesale starting kits furnished. Outline of unique automatic sales plan included. Consolidated Distributors, Division 118, 21 Lafayette, Paterson 15, New Jersey.

EARN Money forwarding letters, clip-pings, etc. Box 211, Reading, Mass.

BUY Wholesale! Thousands nationally advertised items. Save—Make money! Free details. Durex, Box 672-PM, Chicago 90.

"HOW To Make Money With Simple Cartoons"—A book everyone who likes to draw should have. It is free, no obligation. Simply address Cartoonists' Exchange, Dept. 910-CM, Pleasant Hill, Ohio.

BOOKKEEPERS! Forget debits, credits, double entry! Govt. investigators want records, not systems. More firms use our simple, inexpensive method than any other. Popular demand. Unlimited earnings. Age no barrier. Live anywhere. Amazing details free. Penna. Business Service, Box 923, York 3, Penna.

EARN \$50.00 Daily making mats, shoes and mud guards from old tires. S and S Patents Inc., 1307 North Clark St., Chicago 10, Ill.

\$128 IN Sales from \$10.00 material. New, different. Everything furnished. Write K. D. Thompson, Small Point Beach, Maine.

EARN Money evenings, copying and duplicating comic cartoons for advertisers. Adservice, Argyle 1, Wisconsin.

\$200 MONTHLY Possible raising earthworms! Backyard, garage, basement. Complete, illustrated booklet explains raising, feeding, packing, marketing. 25c post-paid! Oark Worm Farm-3, Willow Springs, Missouri.

PRESERVE Color—beauty of living flowers indefinitely. Tremendous profits, fascinating work! Maxson, Falls Church 18, Virginia.

FREE Folio "Startling Unlimited Vacations Plan." No merchandise, equipment. Unknown! Works itself—home! Proven successful. Haylings, Carlsbad, Calif.

LEARN How to make money. Details free! Wrede, Atkinson, N. C.

MOLDS—Figurines. Wholesale circular 10c. Novelties, Box 45 R1, Fremont, Ohio.

LOOKING For something good. Free information. Harvester Equipment Co., Albert City, Iowa.

FOREIGN Employment construction work. If interested in foreign projects with high pay write Foreign Service Bureau, Dept. P.M., Metuchen, New Jersey.

DOLLARS in your mail box daily. No stock investment. Particulars free. Gem, 44-B Atlantic, Pleasantville, New Jersey.

ATTENTION: Typewriter owners. Make handsome profits. Write today. Groves Company, 682, Hastings 8, Nebraska.

JUST An honest living. Tested radio-mail order method. Free details. Carter, 114½ W. Washington, Gainesville, Georgia.

NEWLY Found money in Whitehall's exclusive line of photo novelties, photo finishing, jewelry, Christmas and everyday greetings. New items never before shown. Send for free samples. Be among the first to make big money with Whitehall's photo line. Whitehall Studios, Inc., 24 Main Street, Elmira, New York.

BIG Profits in spare time! I'll send, on free trial, assortment full-size samples fine foods, household necessities to ambitious men—women who need money. Friends, neighbors buy eagerly. Send no money. Just write Blair, Dept. 31MT-2, Lynchburg, Va.

MONEY Troubles? Lack rising costs with little home business. Send 25 cents for new booklet containing dozens of plans and ideas. Atlantic Publications, Box 1103, Riverdale, Maryland.

HARNESS The sun in your own back yard for only a few dollars. You can charge admission for showing how the sun's power can melt metal and create free electricity. Complete plans \$1.00. Solar Power, P.O. Box 212, Streator, Ill.

MAKE Money from your water faucet with Surfashine, the magic cleaner. Literature free. Send \$2.00 for sample gallon. Pyramid Chemicals, 7326 Tireman, Detroit 4, Mich.

TREMENDOUS Profit—Ornaments for dresses, coats, hats, easily made. Sell thousands. Start now! Sample kit 25c. Miles Crafts, 3220P Fish Avenue, New York 69.

RAISE Hamsters—Golden \$4, albino \$10 pair. Information free. Combs, Rural Hall, N. C.

MAKE Extra money selling cast aluminum name plates. For full particulars write McConnell Bros., Springfield, Ill.

START A profitable subscription business in spare time! We need men and women (young or old) as representatives for all leading national magazines. Liberal commissions paid for new and renewal subscriptions. Start earning money in this pleasant work at once! Clip this ad and send with your name and address to: Agency Bureau, Dept. PM, Hearst Magazines, 250 West 55th St., New York 19, N. Y.

KEY Making small investment—Big profits. Everything needed to start. Key machines. Complete setups from \$94.50. Send for free literature. Hugo Solomon & Son, 70 East Warren, Detroit 1, Michigan.

GENERAL Contest Bulletin. Issued monthly. Sample, 25c. 1609½ East 5th, Duluth, Minn.

NEW Baby items. Agents, salesmen, distributors. Natural for mail order. Write: Liebig Industries, Beaver Dam 5, Wis.

100% PROFIT! Mexican featherbird pictures. Hot sellers! Edmunds, 3009-P Weaver Ave., Baltimore 14, Md.

SELL Books, merchandise by mail. Tremendous profits. We furnish everything. Ship your orders. Write: Tradewinds, Box 8238, Chattanooga, Tenn.

GROW Mushrooms. Cellar, shed, and outdoors. Spare, full time, year round. We pay \$3.50 lb. We paid Babbitt \$4,165.00 in few weeks. Free book. Washington Mushroom Ind., Dept. 173, 2954 Admiral Way, Seattle, Washington.

SPARETIME Profits taking subscriptions, all magazines. Wholesale catalog free. Cassell Agency, Westfield 2, New Jersey.

\$0.000 ARTICLES Wholesale. Source directory, dime. Nelko, Box 3462-DR, Chicago 54.

READ Progressive Mailtrade, the magazine that tells how to make money by mail. Dime brings sample and special offer. Progressive Mailtrade, Box 357, Sheboygan, Wisconsin.

PUBLISH Your own magazine. Handsome 52 page format, well edited, illustrated. Cost low as \$1.00 month. Brings you prestige, profits. 25c brings sample, details. National, Ord. Nebr.

WINNING Prize contests is fabulous, confidential, home opportunity! Send stamp! National Contest Bulletin, Box 2685-P, Miami 16, Florida.

FREE Book "505 Odd, Successful Businesses." Work home. Expect something odd! Pacific, Oceanide, Calif.

MAKE To \$4.50 hour doing common pen lettering. National Artists, 801½-A North Marsalis, Dallas 3, Texas.

FREE Literature describing moneymaking mailorder plans. Lewis Barlett, Richland, Georgia.

BUILD Sales by recruiting productive distributors selling direct or to retail outlets. Secure most concentrated circulation through classified columns of Salesman's Opportunity. Write for facts. Gilbert, Salesman's Opportunity, Room 1700, 28 East Jackson, Chicago 4.

WHY Work for others when others will work for you? 50c brings facts in dollar tips. Vernon Glover, 900 Pleasant Valley Ave., Dayton 4, Ohio.

SELL—Buy Titania gems. More brilliant than diamonds. \$9.75 carat wholesale. Free catalogue. Diamondite, 1404-M Mitchell, Oakland 1, California.

OPERATE Profitable mail order business. Roblin Sales, 1001 Curtiss, Downers Grove, Ill.

NEED Money? Sell the sensational BM game. Sample and plan \$1.00. Deming Products Co., 841 Bennett St., Jackson, Michigan.

EARN Money at home serving as magazine representative. No experience. No investment. Write for free catalog and supplies. Hanson Bennett Magazine Agency, Desk P1, 180 N. Wabash Ave., Chicago 1, Ill.

SCHOOL Seniors—Sell classmates America's most beautiful graduation name cards. Largest selection. Highest commission. Outsell all others. Free sample kit. Printcraft, Dept. M, 1509 Maple Street, Scranton 5, Penna.

NEED Extra money? New plan. No investment. Sparetime. Sample, details free. Transamerican, Box 815-A, Atlanta 1, Ga.

FORMULAS, PLANS, ETC.

GUARANTEED Formula. No acids. Cleans cesspools, septic tanks. Free particulars. Reylo, Box 666, Council Bluffs, Iowa.

LIFETIME Business! Manufacture extremely profitable products! Lists free! Thermolab, Peoria 4, Ill.

MODERN Formulas. Literature free. Jack, Consulting Chemist, 5138 Gainor, Philadelphia 31.

FOR Proof of what you can do in specialty manufacturing get our literature. It's free! Miller, Chemist, 1517-P, Tampa, Florida.

ANY Formula \$3.00. Catalog—Mfg. Treatise 10c. J. Belfort, 192 N. Clark, Chicago 1.

FORMULAS: All kinds. Latest, best. Literature free. Kemixal, Park Ridge, Ill.

REAL Manufacturing formulas. Lists free. Cummings, Chemist, Gordon Ave., Syracuse 4, N. Y.

PRODUCT Analysis, manufacturing formulas, processes developed. Moderate fees. Plastics, Box 1574, Boston 4, Mass.

MAKE Big profits manufacturing perfumes. Introductory manual \$1. Fragrance Research Foundation, 1513 Oxford Way, Oklahoma City 14, Oklahoma.

FREE Formula catalog. Anything analyzed \$35. Western Chemical, Salem, Ore.

PLASTICS

PLASTICS Home-craft course for men and women. Tells and shows how to make hundreds of fast selling plastics products. All plastics and materials for 23 projects included in course. No special tools needed. Course pays for itself. Write for free booklet. Interstate Training Service, Dept. D-3-K, Portland 13, Oregon.

HIGH Profits—Jewelry, gifts, novelties. Free catalog. Pilot Plastics, 67-C Fulton, New York 38.

LAMINATORS Increase sales or if you are entering this field we can help you. Details free. National Association Plastic Laminators, 707 Market St., Knoxville, Tenn.

TUBE For water level. See Hydrolevel ad in "Make It Yourself" classification.

PLASTIC, Sheets, rods, tubes, etc. Free list. Plastic Supply Co., 2901 N. Grand Blvd., St. Louis 7, Mo.

FLEXIGLAS Sheets—Cut to size. Clear. All thicknesses. Standard outdoor translucent colors. McClarin Plastics, P.O. Box 168H, Hanover, Penna.

FLEXIGLAS, Lucite. Any size sheets. Square foot (12 x 12) cost, 1/16", \$1.18; 1/8", \$1.55; 3/16", \$1.90; 1/4", \$2.25. Add 15% for postage. Minimum order \$3.00. Almac Plastics, 600 Broadway, New York City.

FLEXIGLAS, Lucite. Square foot cost 1/16"—\$1.16, 1/8"—\$1.53, 3/16"—\$1.88, 1/4"—\$2.23, 3/8"—\$3.28, 1/2"—\$4.38. Colors add 10%. Send 10% for postage. Aristocrat Plastics, Inc., 55 Clarkson St., New York City.

CHEMISTRY

CHEMICALS, Supplies. Catalog. 20c. Laboratory Sales, Box 161-A, Brighton, Mass.

LABORATORY Pyrotechnics manual, interesting and thorough. Contains complete formulas, set-ups, instructions on spectacular chemical experiments, thermites, fulminates, acetylides, nitrogen iodides, explosive powders, etc. Easily modified. Still \$1.00 postpaid. Chemi-Tech Lab, 568DB Riley, Buffalo 8, New York.

AMAZING New book of science. Experiments, formulas and catalogue of laboratory supplies. Only 25c. National Scientific Co., Dept. PM-10, 2204 W. North Ave., Chicago 47, Ill.

GEIGER Counters, \$29.95 up. Free catalog. Atomic Laboratory, Box 343, Berkeley, California.

NEW Idea chemical and apparatus outfits for home experimenting. Photo-scales, microscopes, chemicals, biological and laboratory supplies in small quantities. Catalog 25c. Established 1931. John H. Winn, 124A West 23rd Street, New York, N. Y.

CHEMICALS And apparatus for industrial, analytical, and private laboratories. Catalog 25c. Dept. M-50, Biological Supply Co., 1176 Mt. Hope Ave., Rochester 20, N. Y.

ILLUSTRATED Catalog: Chemistry, mineralogy, biology 20c. Tracey Laboratories, Evanston, Illinois.

BUY IT WHOLESALE

BUY Wholesale direct! Save up to 66 2/3% on nationally advertised appliances, homewares, watches, cameras, sporting goods, toys, giftwares. Free catalog. Wholesalers Mart, Box 6125ER, Houston, Texas.

WHOLESALE Catalog! 30-80% discounts! Nationally advertised appliances, gifts, watches, cameras, tools, etc. Start your own fully self-operating mail order business without capital! No experience necessary. Wholesale starting kits furnished. Outline of unique automatic sales plan included. Consolidated Distributors, Division 142, 21 Lafayette, Paterson 15, New Jersey.

NATIONALLY Advertised merchandise. Rush 30 cents for illustrated catalog showing retail prices to Edward Clemens, 318 W. Bridge St., Morrisville, Penna.

NATIONALLY Advertised appliances, cookware, diamonds, typewriters, watches, etc. Wholesale catalog 50c. J. J. Davis Co., 30 E. Englewood Ave., Englewood, New Jersey.

WHOLESALE: Sell retail, tremendous profits. Nationally advertised products. Individual purchases. Catalog \$1.00. Day, Mount Morris, New York.

APPLIANCES, Watches, housewares catalog 50c. Buda, Box 124, Oneida, N. Y.

SAVE 50-75% On household appliances. Free gift. Wholesale catalog. Nueblings-M. Sicklerville, N. J.

DO Your Christmas shopping, year around buying from your easy chair at big savings. Jewelry, silverware, watches, appliances, toys, power tools. Hundreds of other items. Send 25c for big name brands catalog. Refundable on first purchase. Karlen House, 210 Fifth Avenue, New York 10, New York.

EARLY Christmas shoppers? Wholesale catalog, bonus plan. Complete line nationally advertised merchandise. Pette Company, 1554-PM West 11 Street, Brooklyn 4, New York.

WHOLESALE Name brand merchandise. Big discounts. Individuals buy one or 1,000 items. Catalog \$1.00 refundable first order. Transamerican, Box 815-A, Atlanta 1, Ga.

AGENTS WANTED

CASH in on tremendous demand for new low-priced burglar alarm for cars, homes and farm buildings. Nothing like it. Everybody wants one. 286% profit. Unique sample offer. Northwest Electric Co., 132 Main, Mitchell, S. Dak.

MAKE 20%-50% Cash bonus on generous cash commissions. Take orders for lingerie, blouses, guaranteed hosiery, etc., with self-selling features. Free selling outfit. American Mills, Dept. 436, Indianapolis, Ind.

OWN Your own profitable wholesale merchandising business. No investment! Sell nationally advertised appliances, homewares, jewelry, sporting goods everybody buys. Your own name catalog in color! We drop ship. Free brochure. General Wholesalers, Box 1195EF, Chicago; Box 3058EF, San Francisco.

SELL New 3-dimensional "action" Christmas, birthday, get well cards. Make \$50, \$75, \$100 extra money. Profits to 120%, plus extra cash bonus. Write for feature assortments on approval, free samples personal Christmas cards, stationery, free color catalog, selling guide. New England Art Publishers, North Abington 1032B, Mass.

NEW Plastic mending tape. Just press on! Repairs clothing instantly. Lightning seller. Samples sent on trial. Kristee 62, Akron, Ohio.

SENSATIONAL New portable burglar alarm "The Night Watchman" for homes and all places of business. Combines instant automatic floodlighting with a terrific alarm. One instrument protects every point of entry simultaneously such as doors, windows, etc. Merely plugs into any convenient electrical outlet the same as a radio, floor lamp, etc. Deluxe in appearance. All electrical parts Underwriter Laboratories approved. Sells on sight. Convenient to handle. Weight twelve pounds. Sells for only \$89.50. You make \$20 on each instrument. Send for circular matter and information on exclusive territorial rights. Chicago Alarm Company, Manufacturers, 2252 W. 111th Place, Chicago 4, Illinois.

SPARE Time money plus new car as encouragement bonus. Amazing 60 gauge nylon 3 pairs guaranteed 3 months. Write Wilkint, 17410 Wash., Greenfield, Ohio.

AGENTS—Sell most space saving tie racks. Big easy seller, 150% profit. Three sizes. Details free. James Products, 1625-50th Ave., Cicero, Ill.

GOLD Letters, 25c. Frank Watkins, 1241 Overton Park, Memphis, Tennessee.

"FOG-STOP" windshield cloth. Instantly removes blurry mist, frost, sleet, snow. Stops windshield fogging. Samples sent on trial. Kristee 61, Akron, Ohio.

PROFITS Unlimited in your own wholesale buying service. Save yourself 66 2/3% on 10,000 nationally advertised appliances, homewares, jewelry, sporting goods. Big profits selling others at discount! Free details. National Buyers Service, Box 426EC, Oakland, California.

TALKING Christmas cards say aloud "Merry Christmas." Six samples only \$1. No duty, refundable. Talkie Cards "A," Box 265, Station "B", Montreal, Canada.

AMAZING Profits for you selling Sunshine quality Christmas cards. No investment or experience necessary. Nationally famous 21 cards for \$1.00. Sells on sight! Imprints, Currier-Ives, religious, gift wraps, many others. Samples on approval, write: Sunshine Art Studios, Inc., Dept. PM-10, Springfield 1, Mass. Pasadena 3, Calif. (Note: East of Rockies address Springfield office.)

FEATHERBIRD Pictures from Mexico! 100% fast, easy profits. Prompt service. Free details. Jacaman (PM-10), Box 1342, Laredo, Texas.

BUY Wholesale thousands nationally advertised products at big discount. Free "Wholesale Plan." American Buyers, 629-R Linden, Buffalo, N. Y.

MONEY For Xmas! Make \$50 and more during spare time. Friends, neighbors—everyone buys from Elmira's exquisite new sparkling line. Imprinted Christmas cards for as little as 3c. Personalized stationery, napkins, large gift wrappings with free accessories, ribbon ties. All fine quality money saving values. No experience needed. Send name and address for free portfolios, catalog, assortments on approval. Bonus plan. Elmira's "portable gift shop" makes money first day. Write today. Elmira Greeting Card Co., Dept. C-201, Elmira, N. Y.

REVOLUTIONIZES Rubber stamp business. 100% profit. Send 10c for sales plan. Fisher's, Dept. EM10, 4736 So. Central Ave., Los Angeles 11, Calif.

BEAUTIFUL Feather pictures. 200% profit! Free sample. Apartado 9036, Mexico 1, D. F.

AT Last! Something new and sensational in Christmas cards. Make extra money fast! Show satins, velours, metallics. Gets easy orders. Pays up to 100% cash profit. 30 free samples. With name 50 for \$1.50. Big line. Amazing new Glitter-Brite ornaments, napkins, gifts, stationery. Several \$1.00 boxes on approval. Puro Greetings, 2801 Locust, Dept. 440-M, St. Louis, Mo.

MAKE Money fast—For yourself, church, organization. Selling friends, neighbors big value \$1.00 and \$1.25 Christmas and all occasion greeting cards. Leading 21 card boxes, religious and novelty assortments. Gift wrappings, stationery, children's items, gifts, gadgets. Deluxe imprinted Christmas cards. Over 200 items. Profits to 100%. Experience unnecessary. Free gift for promptness. Bonus. Free selling plan! Samples on approval. Hedenkamp, 361 Broadway, Dept. PM-35, New York.

AGENTS Wanted; Make much money selling famous "Sweet Georgia Brown" beauty products. Hair pomade, face creams, face powder, perfumes. Write for free sample offer. Valmor, 2451-KB Michigan, Chicago 16, Ill. USA.

MAKE Money introducing world's cutest children's dresses. Big selection, adorable styles. Low prices. Complete display free. Rush name. Harford, Dept. M-4341, Cincinnati 25, Ohio.

MAKE Money at home as renewal headquarters for all magazines. Big Christmas sales profits now. Liberal commissions. Supplies furnished. Write for free catalog. McGregor Magazine Agency, Dept. 509A, Mount Morris, Ill.

BUY Wholesale—25,000 items. Catalog 25c. Matthews, 1472-B1 Broadway, New York City 36.

FREE New 1954-55 wholesale catalog free. Appliances, household items, toys, gifts, jewelry, refrigerators, radios, air conditioners, washing machines, freezers. Hundreds of items on which you can make a handsome profit. Space on cover for your own name and address. Write today for big wholesale illustrated catalog free. Halen, Inc., 125 Fifth Ave., Dept. M, New York, N. Y.

YOUR Own business! Amazing profits! Constant repeat orders! Start a permanent business. Steady income. America's fastest selling household and industrial article for 35 years. Tremendous market! Sells quickly! Exclusive territory! Write now for special no-risk offer. Dominant Products, 359 Pearl St., New York 38, N. Y.

FREE Hosiery! Sensational new way to earn to \$3 hour spare time! Introduce amazing hosiery by giving away free pairs to every man and woman, regardless whether or not final purchase is made! Nationally known luxurious nylon stockings guaranteed against runs. New miracle one size two-way stretch nylon socks, fit any size. Never sags or droops. Guaranteed one full year! Buy nothing. Deliver nothing. Advance cash plus huge cash bonus to 40%. Additional hose and gifts extra bonus. Postcard brings you samples of stockings and socks with money-making outfits absolutely free. No obligation. Kendex, Babylon 73, N. Y.

GOOD, Steady income. Magica Rust Spot Remover. Tutechon furniture cleaning, polishing and revitalizing cloth. Nothing like it. Your profit 100%. Magica Products, Andover, Mass.

EARN \$100 Cash and more by Christmas plus valuable contest prizes! Just take friends' and neighbors' subscription orders for all magazines. Write today for free supplies to J. Foster, Coronet Agency, Dept. M, 488 Madison Ave., New York 22, N. Y.

ADVERTISED Watches, diamonds, pens, wholesale. International, 61R Roberts, Portland 4, Maine.

BUY Wholesale—Thousands items. List free. A Sales, 18 PM City Terrace, Newburgh, N. Y.

APPLIANCES, Cameras, watches! Large wholesale catalogue! Cam Company, 6806PM-20th Ave., Brooklyn 4, N. Y.

ENJOY 3 Color television filter screen now easily attached. Send \$2.00 for your screen size. Satisfaction guaranteed. S. George, 5008 Stenton Avenue, Philadelphia 44, Pennsylvania.

SELL \$3 Fire extinguisher. Every car owner and household a prospect. A real money maker. Fire Killer Co., 2481 Westport St., Baltimore 30, Md.

350% SNAPPY Store signs sell! 10 signs \$1; sell \$3.50. Free lists. Southern, 1500 No. Fort, Corpus Christi, Texas.

60% PROFIT On cosmetics—Famous nationally advertised Hollywood Cosmetics pay 60%! Make \$25 day up! Hire others. For free samples, details, write Studio Girl, Glendale, Calif., Dept. PM-104.

EASY Handwork makes fast-selling useful articles. Sample free. Sunmade Company, Brockton 64, Massachusetts.

NEW Magic fabric selling like wild. Sample free. Write Glen-Zall, 86 S. Wolcott St., Hillsdale, Mich.

AGENTS. Big money selling raised wood letters. Sign Letter Distributors, P.O. Box 101, Mineola, N. Y.

WINDOW Letters—Gold, silver, colored. Metropolitan, 316 W. 42, New York City 36.

EXTRA Money every week. I'll send you full-size Blair household products on free trial. Show them to friends and neighbors. You can make big extra profits. Write Blair, Dept. 31MT-1, Lynchburg, Va.

NEW Magic garbage can holder beautifies can, prevents rusting, animals from upsetting. Low priced, sensational seller. Free photos. Kessler Corporation, 10AG, Fremont, Ohio.

TWO New ball point pens, plain and retractable, with lifetime written guarantee. Two samples 50c. Nucleus Trading, 2440 Amsterdam Ave., Dept. M-10, New York City 35.

UNEQUALLED Christmas door knocker. Mounted brass sleigh bells. No competition. Sample \$3.50. Darchester, B114, Cincinnati 13, Ohio.

WHOLESALE Catalogue appliances, watches, tools, toys, cameras, clothing. Catalogue. Distributors Co., Box 672, Worcester, Mass.

MUSIC Greeting cards. Christmas specialties. Dorby Publications, Parsonage, Cummington, Mass.

RETRACTABLE Ball pens, top quality, big profits, details free. Davis Company, 483-A Clinton Avenue, Brooklyn 38, N. Y.

MEN—At last a d.e. razor blade unconditionally guaranteed. Made of finest quality surgical steel. At the low price of 100 blades \$1.00 check or m.o.; 25, 30c coin. Agents wanted. David Pittel, 4640 Jackson Blvd., Chicago 44, Illinois.

BIG Profits selling unique Kiddietales Giftpak. Proven, fast seller. Practically no sales resistance. Get started now. Send for free details. Pisco, 815 Locust, Pittsburgh 19, Penna.

SELL Imported slide rules to students. Hoffman, 662P, Passaic, New Jersey.

BIG Profits selling ties (\$2.00 value) \$6.50 dozen. Free catalog. Empire Cravats, 811C Broadway, New York 12.

MAGIC Thread, mends! Without sewing. Terrific seller and repeater, big profits, 30-second convincing demonstration. This amazing invisible liquid repairs, patches any fabrics in seconds. Won't wash off. Send 85c (refundable) for sample or write for more details. Utility Products Co., Vinerville, New York.

IMMEDIATE Success! Sensational profits! Used suits \$1.75, pants 35c, dresses 20c, shoes 20c. Operate from store, home, car. Free catalog. Superior, 1250-A Jefferson, Chicago 7.

EASY Extra income—Sell sensational new silicone scorch resistant ironing board cover. Good Housekeeping approved. Terrific \$1.98 seller! Send for free complete selling kit. Sample cover \$1.10. Menell Products, Dept. P—P.O. Box 431, Midtown Station, New York 18, N. Y.

HAVE A complete store in your pocket. Buy wholesale and make big profits. Send for free general merchandise catalog now. Jay Norris, Dept. P, 445 Broome St., New York City.

PRINTING. Advertising salesmen—Excellent moneymaking sideline selling decalomania name plates, small quantities. Automobile initials, sign letters. Free samples. Ralco, XL, Boston 19, Mass.

CALIFORNIA Sweet smelling beads. Sensational sellers. Free particulars. Mission, 2328PM West Pico, Los Angeles 6, Calif.

GOLD Or silver letters, numbers. Windows, doors, trucks, 1" to 6". 500% profits. Free samples. Atlas-T, 544 West 79th, Chicago 20.

\$1.00 PROFIT Selling \$2.95 photo enlargement deal. Allen Studio, Riegler Bldg., Little Rock, Ark.

MAKE Extra money. Sell front door name plates to friends, neighbors. Retail \$1.98; you make \$1.00! Free selling kit. Modern Engraving Co., P.O. Box 194, Boston 14, Mass.

AGENTS—300% Profit selling genuine gold window letters; stores and offices. Free samples. Metallic Sign Letter Co., 431-D North Clark, Chicago.

IT'S So terrific you'll actually sell thousands! Brand new \$2.95 pocket check protector. Sales pouring in. A tremendous deal for you. Get your town today. Federal Products, Evanston 15, Illinois.

BARAINS, Job lots, close-outs! Save up to 50% on clothing, hosiery, notions, drugs, toiletries, gifts, jewelry, television, etc. 2000 items. 25c brings wholesale bargain catalog with special get acquainted offer which includes free \$1.00 merchandise certificate. Reliable Jobbers, 311-B North Desplaines, Chicago.

YOUR Own business—Used suits \$1.50, overcoats 65c, mackinaws 35c, shoes 12¹/₂c, ladies coats 30c, dresses 15c. Enormous profits. Catalog free. Moro, 1218AA South Jefferson, Chicago 7.

FREE—Big new wholesale catalog! Up to 50% saving for you, family, friends on nationally-known gifts, mdse.; hosiery, appliances, cards, etc. Also make money selling part time! Write today. Evergreen Studios, Box 846-AC, Chicago 42, Ill.

\$200 WEEKLY. New invention. Amazing 4-second Presto emergency tire chains, fit all modern auto wheels. National advertising building big demand. 3 sales daily to oil stations, dealers, etc. make \$200 or more weekly. Territory going fast. Write Presto Chain Co., Dept. P-30, Des Moines 2, Iowa.

SCHOOL Seniors—Be popular with classmates. Have spending money galore. Details free. Craftcards, Box 235-L, Pittsburgh 19, Pennsylvania.

SCHOOL Seniors—Earn sensational profits selling classmates America's most beautiful graduation name cards. Largest selection. Outsells all others. Free sample kit. Printcraft, Dept. M, 1509 Maple Street, Scranton 5, Penna.

FREE Directory listing. Register name, address. Receive agency offers automatically. Save time, postage. No obligation. Transamerican, Box 815-A, Atlanta 1, Ga.

SALESMEN—DISTRIBUTORS

SALESMEN, \$50.00 In a day definitely assured, selling brand new item going to every type of food and beverage store, factories, laboratories, hospitals, etc. Samples furnished. Utility Durawear, 53 West Jackson Blvd., Dept. PM-10, Chicago 4, Ill.

MAN To earn \$150 up per week. Long needed invention. Advertised worldwide. Prospects everywhere. Full or part time. Exclusive. No investment. Free use of samples. Write Red Comet, Inc., Dept. 392-M, Littleton, Colorado.

ANYONE Can sell famous Hoover uniforms for beauty shops, waitresses, nurses, doctors, others. All popular miracle fabrics—Nylon, dacron, orlon. Exclusive styles, top quality. Big cash income now, real future. Equipment free. Hoover, Dept. G-100, New York 11, N. Y.

SELL Advertising embroidered work uniforms and bowling shirts. Make big money full time, spare time. Huge selection of styles, fabrics, colors. Every business a prospect. Giant panoramic line makes sales on sight. It's free! Write Topps, Dept. 5310, Rochester, Indiana.

AD Matches! Sell amazing designs—10, 20, 30, 40 and 240-light book matches. Bigger spot cash commissions; every business a prospect. Low prices for high quality. Repeats. Start without experience; men, women; full, part time. Buy nothing! Sales kit furnished. Match Corp., Dept. PM-38, Chicago 32, Illinois.

BUY Wholesale thousands nationally advertised products at big discount. Free "Wholesale Plan." American Buyers, 630-DD Linden, Buffalo, N. Y.

SELL "Dandy"—Fast moving automotive accessory. Dandy, Box 5, Columbus, Ind.

ADVERTISING Book matches—Cash in on big demand; sell union label matches. Cuts for all businesses and political parties. Free powerhouse selling kit, low prices, protection guaranteed on repeat orders. Cash commissions. Superior Match Co., Dept. M-1054, 7530 Greenwood, Chicago.

NEW Chemical discovery. Pro Auto Wax, easy way to car beauty. Free sample, information. Amazing profits. Burford Auto Finishes, 1660-20th Street, Santa Monica, Calif.

WE'VE Got them! The hottest selling items for Christmas plus the sensational new Christmas card, "Christmas Greetings on Records." Everyone buys. Send 50c for samples or write for details. Arturo Productions, Inc., Highway 35, Neptune, N. J.

GET New shirt outfit free; make \$90.00 weekly on 5 average orders a day. Famous quality made-to-measure dress and sport shirts at \$3.95 up sell fast to all men. No experience needed. Full or part time. Write: Packard Shirt Co., Dept. 740, Terre Haute, Ind.

BABY'S First shoes bronzed for lifetime keepsakes, as bookends, ashtrays, desk sets, portrait stands. Demand unlimited. Profits big. Miniature demonstration shoe free. Senti-Metal, 236 E. Capital, Columbus, Ohio.

A Postcard can put you in a fine business! Complete line. Leather jackets, 160 shoe styles. Big commissions. No experience, no investment. Send postcard for free outfit. Mason Shoe, Dept. MC33, Chippewa Falls, Wis.

BIG Money-making opportunity. Exclusive line work uniforms. Jackets, pants, shirts, coveralls. Advertising embroidered. Every business prospect. Outfit free. Master Div., 260 Water, Ligonier, Ind.

AMAZING New hand cream. Does wonders. Entirely different. Whirlwind seller. Fast repeater. Free moneymaking offer. Sargeant Co., Highland Mills, N. Y.

AGENTS, Salesmen, buy standard brand merchandise at rockbottom wholesale prices: \$49.50 watches at \$22.95. \$49.50 dinner sets at \$15.60. \$1.00 ladies first quality nylon hose at \$6.50 per dozen. Ladies closeout \$8-\$10 fall and winter dresses at \$1.50. Other sensational values in clothing, silverware, jewelry and appliances. Minimum order \$10.00. Send \$1.00 for catalog with confidential price list. Refundable first order. Merchandise Dept., P.O. Box 66, Bronx 59, New York.

PERMANENT Awnings—\$9.95. Aluminum frames. Saves 50%. Commission deal. Sales kit, free. Smith Agency-51, Excelsior Springs, Mo.

HAIRTRIMMER \$1.00! Metal razor attachment, instantly converts Gillette and others. 110% profits! Terrific seller. Saftim, Escondido, California.

PRINTING Salesmen—Increase income. Write Acorn Print Shop, Paso Robles, California.

CHAIN Saws. Wheel mounted. Timber-brush cutting. Fall-winter. Wholesale deal. Farmco-PM, Excelsior Springs, Mo.

SENSATIONAL Demand for world's finest training course and professional equipment. Financial independence if you can qualify as our representative. Captivating sales kit. Invisible Reweaving Institute, La Mesa, California.

NEW, Marvelous foot preparation. Great for foot soreness, ingrown toenails, corns, calluses. Sells like wildfire. Quick repeater. Moneymaking offer free. Sargeant Pharm. Co., Highland Mills, N. Y.

MAKE \$15,000-\$50,000 Yearly your own business. Get exclusive franchise for amazing new "Lambert-Line" of air sanitizing, deodorizing, disinfecting chemicals and equipment needed in every office, home, store, factory. Dramatic demonstrators. Moderately priced, fast, easy sales, steady repeats. Excellent profits. Permanent. Opportunity unlimited. Write today for free facts. Lambert Research Laboratories, Dept. 18410, St. Louis 16, Mo.

MONEY Making opportunity! Take big profit orders for world famous patented varieties fruit trees. Also flowering shrubs, roses, vines. Big sales outfit free. Stark Bro's, Desk 30105, Louisiana, Mo.

QUALITY Ties—Your profit, 189%. Catalog free. Loren Specialties, 4351-A10 Flournoy, Chicago 24.

FANTASTIC New money-making plan. Sell nothing, yet make \$30 or more daily. Leave samples luxurious stainless steel tableware with women. Offer complete set free if they sell two sets to friends. Complete price 30-piece set only \$14.95 instead of usual \$40 or more, yet you make \$15 profit each transaction! Postcard brings complete money-making outfit free. No obligation. Topval Corp., Lindenhurst 10, New York.

SENSATIONALLY New, 100 year calendar, vest pocket size. Very reasonable. Sells on sight to all business houses. Big commission. Send 25c for samples. Specialties Sales Co., 339 W. Schiller St., Chicago 10, Ill.

GOOD Man can make \$3,000 next 90 days. Every house in town wants amazing NiLite glowing curbside numbers. Automatic free trial plan pays profits day after day. Write for free details. NiLite, 173 W. Madison, Dept. 312, Chicago 2, Ill.

30,000,000 WOMEN Want amazing new automatic refrigerator defroster. You sell 8 out of 10 on sure-fire free trial. \$250.00 weekly profit not uncommon. Rush postcard for guaranteed plan. D-Frost-O-Matic, Dept. T-102, 173 W. Madison St., Chicago 2, Ill.

DISTRIBUTORS. Large profits. Terrific repeat orders. Unique Italian brooms. Write Peacock, 400 Montgomery Street, San Francisco, California.

NEW Jobs open in selling! Send name, address for five free issues of Opportunity Magazine's money-making guide, listing hundreds of companies who'll pay you well, full or part-time. No experience needed. Opportunity, 28 E. Jackson, Dept. 17, Chicago 4, Ill.

EDUCATIONAL AND INSTRUCTION

BE Popular! Play piano by note. Send for Simplified Piano, Chord and Harmony Course complete only \$3.98. Coppage Enterprises, 3353 West Maricopa Drive North, Phoenix, Arizona.

COMPLETE Your high school at home in spare time with 57-year-old school. Texts furnished. No classes. Diploma. Information booklet free. American School, Dept. X745, Drexel at 58th, Chicago 37, Illinois.

BLUEPRINT Reading for machine and building trades. Train at home. Learn to read blueprints with confidence in 10 easy lessons. Literature free. Belton School, 1059D North Lawndale, Chicago 51, Illinois.

PRACTICAL Nursing—Learn easily at home, spare time. Big demand, good earnings. High school not necessary. Write for free facts. Wayne School, Dept. FG-24, 2525 Sheffield, Chicago 14, Ill.

PLAY Guitar in minutes! 66 diagrams, illustrated instructions, 8 sample songs, \$1.00 postpaid. Guitarist, Bradley Beach 3, New Jersey.

SIMPLIFIED Analytics teach algebra clearly, \$1. Another, "Science Magic" proves discoveries plainly, \$4. Both guaranteed. Ziemba, H-6123 Orchard, Dearborn, Michigan.

DIPLOMAS, Home-study, degrees. Folder #118 free. Aurea, 156 West 73 Street, New York City.

BOOKS Government surplus education manuals. Trade and vocational subjects. About one fifth regular price. Free catalog. Long's College Book Co., Dept. PM, Columbus 1, Ohio.

HIGH School—No classes. Study at home. Spare time. Diploma awarded. Write for free catalog HP-48. Wayne School, 2527 N. Sheffield, Chicago 14, Ill.

HOW To write short stories, mysteries, articles. Learn at home for career or extra part-time income. (A. Aretz sold first 2 stories for \$255.) Professional writers show you how. Send today for free book and lesson material which explain opportunities. Clip this reminder ad. Palmer Institute of Authorship, Desk TM-104, 1680 N. Sycamore, Hollywood 28, Calif.

WANT A diesel job? New opportunities to increase income. Higher pay. More money. We can help you qualify. Tools. Shop method home training. Write today! Diesel, Tractor, Heavy Equipment Division, Interstate Training Service, Dept. B-3-K, Portland 13, Oregon.

OWN Collection agency office—Pays big! Free details. Franklin Credit, Roanoke 7, Va.

UPHOLSTERY—Become professional at home. Big earnings. Free book. Write Upholstery Trades School, Dept. CR-1402, 721 Broadway, New York 3.

BE A real estate broker. Study at home. Write for free book today. GI approved. Weaver School of Real Estate, 2020C Grand, Kansas City, Missouri.

HOME Study course, drugless therapy. Free literature. Institute of Drugless Therapy, Tama, Iowa.

IT'S Fun learning a language by Linguaphone. At home, quickly, easily learn to speak French, Spanish, German, Russian, Modern Greek—29 languages by Linguaphone, world's standard conversational method. It's like living in another country. Save time, work, money. Send for free book. Linguaphone Institute, 8310 RCA Building, New York 30.

WELDING Training pays at Hobart Welding School, Box M-1041, Troy, Ohio. VA contract. Best equipment. Catalog free.

LEARN Refrigeration mechanics. Complete illustrated course. Free booklet. Mechanics School, 7217-PM South Broadway, Los Angeles 3.

METALLURGY Easily learned at home. Prepare now for this big income field. Write Fran Council, Box 150, Wildwood, New Jersey.

USED Correspondence courses and educational books bought, sold, rented. Catalog free. Educational Exchange, Summer-ville, Ga.

SHORTCUT Public bookkeeping guarantees mansized steady income! Simple instructions. Start home, spare time. Auditax, 34651BA, Los Angeles 34.

HAVE Fun learning to read, write and speak Spanish and other languages with this new fascinating, quick and easy method of playing cards. Approved by colleges. Ideal gift. Write Elco Products, 60 Holt, Dayton 7, Ohio.

LEARN Appliance service. Motors, washers, refrigeration, everything. Booklet. President, Box 73136, Los Angeles 3.

SUCCESS Begins with new ideas. Free literature. Decoray, 634-A Union St., Brooklyn 15, New York.

NEW, Uncrowded profession, part, full time. Know people. Analyze handwriting, earn big fees. Business men, housewives, doctors, attorneys, teachers use and report success from radio, writing, lecturing, teaching, consultation, court work. Trial lesson free. Give age. Igas, Inc., 414 Wilhoit Building, Springfield, Missouri.

DO You impress people when you talk? Is your voice strong, confident, self-assured—or does it lack training? Everyone needs trained voice to make most of himself. Free booklet has important facts. Write for it today. Perfect Voice Institute, 210 South Clinton, Studio 2KW-2, Chicago 6.

SMASH Worries, problems with our life-changing "Behavior Control Method." Exciting details free. Applied Christian Psychology, Box 1924-E, Louisville 1, Ky.

INCREDIBLE! Become mental superman overnight! Free booklet! Bilou, Box 1727-MR, Hollywood 28, California.

CORRESPONDENCE Courses, books, rented, sold, bought. Catalog free. Press, Box 1272-P, Burbank, Calif.

PORTO-Lab—Portable classroom laboratory. Elementary science equipment. Manual (21 subject sections, 185 experiments). Complete unit \$36.50. f.o.b. New York. Porto-Sales, Dept. 1054, Morrisonville, Illinois.

DRAFTING—Learn from registered professional engineer. Lowest priced simplified method. Placement service. Write Genco, 32-B Greenacre Road, Westwood, Massachusetts.

WORK For U.S. gov't! Men—women, 18-55. Start high as \$350.00 month. Qualify now! 23,000 jobs open. Experience often unnecessary. Get free 36-page book showing jobs, salaries, requirements, sample tests. Write: Franklin Institute, Dept. W-24, Rochester, N. Y.

MIDLAND Linotype School. Charles City, Iowa. Civilian and Veteran Courses. Free placement. Established 1909.

MEDICAL Laboratory technique. Learn at home. Catalog free. Century College, 9 East Ohio, Chicago 11, Illinois.

CORRESPONDENCE Courses, educational books bought, sold, rented. Catalog free. Willard Bayles, 211 Essex, Hackensack, New Jersey.

HIGH School diploma at home. Licensed teachers—Approved materials. Southern States Academy, Box 144-MX, Station E, Atlanta, Georgia.

STUDY By correspondence for Doctor's degree in Psychology, Metaphysics and Divinity. College of Divine Metaphysics, Dept. P-M, 2811 North Illinois St., Indianapolis 8, Indiana.

SECRET Investigation. Experience unnecessary. Investigators particulars free. George Wagner, M125 West 86th, New York 24.

PHYSICAL Therapy and massage. We train you at home. Earn big profits from your own private practice or work with hospitals and doctors. Free catalog. National Institute, Desk 4, 4868½ Sheridan Road, Chicago 40, Illinois.

GROW Mushrooms. Cellar, shed, and outdoors. Spare, full time, year round. We pay \$3.50 lb. We paid Babbit \$4,165.00 in few weeks. Free book. Washington Mushroom Ind., Dept. 174, 2954 Admiral Way, Seattle, Washington.

EARN While you learn. Auto and diesel mechanics master this top paying trade. Many graduates earn \$100 a week and up. Approved for Korean veterans. For free information write Dept. No. 256, Nashville Auto-Diesel College, Nashville 3, Tenn.

BOOKKEEPERS! Increase your earnings! Operate your own simplified "Dollar-A-Week" bookkeeping and tax service. Full or spare time. Details free. No obligation. Ellis, Box 200, Cedar Grove, North Carolina.

MEDICAL Laboratory technicians in great demand. We train you in your own home. Catalogue free. Imperial Technical Institute, Box 973-J, Austin, Texas.

INVESTIGATOR Training. Phillips Secret Service System, 1917-B North Kenneth, Chicago 39.

USED Correspondence courses and books sold and rented. Money back guarantee. Catalog free. (Courses bought.) Lee Mountain, Pisgah, Alabama.

UNIVERSITY Degrees by residence and correspondence. Golden State University, Hollywood, Calif.

GOVERNMENT Position! Home training for examination, \$9.95. Refunded if don't pass. Write, Ozment Instructions, 34-CS, St. Louis, Mo.

AUCTIONEERING. Be an auctioneer. Earn big money. Term soon. Write for catalog. Kansas City Auction School, Suite 307 Shankman Building, 3119 Troost, Kansas City, Missouri.

PIANO Tuning pays. Learn this profitable profession at home easily with patented Tonometer and mechanical aids. No knowledge music necessary. Diploma granted. Write for booklet. Niles Bryant School, 3731 Stockton Blvd., Dept. P, Sacramento 26, California.

CAMERA Repairmen greatly needed! You can learn manufacturers' service methods at home, in your spare time! Free, big illustrated book tells how! Write today. National Camera Repair School, Dept. PM9, Englewood, Colorado.

"INDUSTRIAL Drafting Opportunities." Free booklet. Write—Industrial Training, 1704-A Frederick, Fort Worth 7, Texas.

PLAYS, STORIES, MANUSCRIPTS

WRITERS! Earn cash re-writing newspaper clippings. Particulars. Underhill, Beebe, Arkansas.

NO Luck finding a book publisher? Write for free Booklet PM. Vantage Press, 120 W. 31, New York.

HAVE Your book published by Nelson-Hall, 204 South Clinton, Chicago 6. (Founded 1909). Free details.

BUSINESS SERVICE

100 ELECTRIC Individually typed, edited letters; resumes; (20) lines \$5 postpaid (25c each extra line); send payment, copy: Nelson Typing Specialists, 34 Park Row, New York City.

SPECIAL SERVICES

INFORMATION On anything. Ferguson Research Specialists, 116-14 141 St., South Ozone Park 38, N. Y.

OPPORTUNITIES In sunny California. Help wanted ads air mailed \$1. Hays, Box 24488, Los Angeles 24, California.

LETTERS Remailed from France, England, \$1.00 each, six for \$5.00. Box 78, Arverne, N. Y.

HELP Wanted ads New York City 50c, letters remailed 15c. Bouris, 146-42 61 Road, Flushing, N. Y.

CARTOONING, COMMERCIAL ART, SHOWCARD & SIGN PAINTING, TATTOOING

"HOW To Make Money With Simple Cartoons"—A book everyone who likes to draw should have. It is free; no obligation. Simply address Cartoonists' Exchange, Dept. 910C, Pleasant Hill, Ohio.

PAINT Signs and show cards. Biggest complete course with 324 illustrations (18 in colors) \$5 postpaid. Descriptive circular free. E. C. Matthews, 2325 Cass, St. Louis 8, Missouri.

ATTENTION—Sign painters-hobbyists. 14 sets alphabet, monogram, numeral patterns. $\frac{1}{2}$ "-4" high. \$1.00 postpaid. Walker Studio, 210-A, 4343 Lindell, St. Louis 8, Mo.

CHALK Talks. Laugh producing program \$1.00. Catalog 10c. Balda The Cartoonist, Oshkosh, Wisconsin.

TATTOOING Course, supply brochures 25c. Zeiss, 728 Lesley, Rockford, Illinois.

ADVERTISING AGENCIES, LETTER WRITERS, FOR ADVERTISERS

MAILING List. Our cash buyers. Names 100, \$1.00; 1,000, \$5.00. Richmond Enterprises, Box 1003, Augusta, Georgia.

SENSATIONAL Mail order advertising handbook. Methods, tests, publication rates, all the answers. Written by national agency. 25c BT Advertising, 2108 B Payne Avenue, Cleveland 14, Ohio.

DYNAMIC Sales letters bring tremendous business. Hansen Associates, 5254 Grove, Skokie, Illinois.

ADVERTISING—Display, classified. Experts since 1893. Interesting budget brochure free. Newmark's Agency, 217-7th Ave., New York.

MAILING Lists, most any classification. 1000 names \$5.00. 1000 your circulars mailed with ours \$4.00. 5000 your circulars printed and mailed \$12.95. Write Dixie Mailers, King, North Carolina.

ADS Placed in out of town newspapers and magazines. Low rates. Catalogue free. Ideas that pay. Baker Advertising Agency, Successors Ankrum Agency, 189 W. Madison, Chicago 2.

FREE Copy, layout service. Mailorder ad, 1,600,000 nationwide circulation, \$28.70 inch. 24-word classified, 20 big Sunday newspapers, \$30. Advertising ratebook free. Chicago Advertising Agency (Established 1900), Chicago 4

FREE! 1954 Advertisers Rate and Data Directory. 52 pages! E. H. Brown Advertising Agency, 20 N. Wacker, Chicago 6.

ADVERTISE: 24 Words, 100 Canadian newspapers \$5.50. Lists free. Advertising Bureau, 10511-C Springfield, Chicago 43.

FRESH Mailing lists. Guaranteed. Opportunity seekers, mail buyers agents, births. Many other classifications. Free literature. Transamerican, Box 815-A, Atlanta 1, Georgia.

RUBBER STAMPS AND OFFICE SUPPLIES

LINE 25c; 2-45c; 3-65c. Stamp Works, Auburn, Nebraska.

300 DIFFERENT Standard worded stamps. Any 6—\$1.00. 3 line cushion or pocket stamp 60c. Gummed stickers 500, 50c. Gummed labels any size. Business cards 1000, \$3.55. Offset and complete printing service. 100% guarantee. Get catalog first 10c refunded. Esco 1104 Print, 8 Holt, Dayton 7, Ohio.

3 LINES \$1.00. Prompt, accurate. Graphic, P.O. Box 852, Oakland 4, Calif.

3 LINES, \$1.00. Fast service. Quality printing, reasonable. Samples. Johnson Press, 443 MacDonough, Brooklyn 33, N. Y.

RUBBER Stamps by professional craftsmen. 3 lines \$1.00. Price list. South Coast Press, P.O. Box 2074, San Bernardino, Calif.

TYPEWRITERS, DUPLICATORS, OFFICE DEVICES

POSTCARD Duplicator, automatic feed, with supplies, \$16.00 postpaid. W. Cooke, Box 40, Scarboro Junction P.O., Ontario, Canada.

RECONDITIONED Typewriters, duplicating, printing devices, \$25.00 up. Supplies. Appliances. DixieGraph, King, N. C.

PRINTING, MULTIGRAPHING, MIMEOGRAPHING, GUMMED LABELS

35% DISCOUNT On quality printing! Free samples plus dollar-value coupon. Liddin, 3813-L Winslow, Ft. Worth 9, Texas.

500 GOLD Name and address stickers \$2.00. Labelprint, 4675 W. Virginia, Denver 19, Colorado.

PHOTO-Offset printing specials. Get free information. Mimeo, Madison, Tenn.

BUSINESS Printing. Samples, catalog 10c. Howprint, T23-M Eunice, Webster Groves 19, Mo.

QUALITY Offset printing—Budget prices, samples, quotations free. Gibraltar Printers, 1610 North Second, Clinton, Iowa.

150 EACH—Letterheads, envelopes, \$2. Bryan, 2547 Fourth, San Diego, Calif.

FREE Samples, airmailed distinctive letterpress, color litho, raised printing. Prompt service. D & M Sales Co., Sebastopol, Calif.

OFFSET Printing \$8.50 — 1000, 8 $\frac{1}{2}$ x 11, 16 lb. National Letter, 1463 Broadway, New York 36.

1000 RAISED Printing business cards \$3.99 postpaid. Excellent quality, complete catalog free. Arthur Steinbergen-Printers, 1274-D Stebbins, New York City 59.

100 8 $\frac{1}{2}$ x 11 LETTERHEADS. Printed carefully, \$1.00 postpaid. Envelopes same. Race Printers, Hudson, New York.

SALES And order books, envelopes, statements. E-R Press, New York City 72. Free catalog.

MIMEOGRAPHING. Surprisingly different, colors, samples. Lee, 8 Gables Drive, Hicksville, N. Y.

COLLECTION Stickers get results, politely. Prices exceedingly low. Embossed business cards, raised letters, add prestige. Samples free. M-P Distributing, 130 Sutphen, Santa Cruz 5, Calif.

1000 PROCESS Embossed business cards, \$3.95, postpaid. Free card case. Dellkay, Woodcrest, Haddonfield, New Jersey.

OFFSET Printing—Drawings, patterns, catalogs, etc. Free estimates. Tradewind Displays, P.O. Box 2650, Denver 1, Colo.

BUSINESS Cards. Printing. Reasonable. Free samples. Lites, 5352-PM Princeton, Chicago 9.

BUSINESS Cards, 1000—\$2.50. Samples free. Rush service. Fuller's, 41 Brewster, Providence 6, R. I.

MIMEOGRAPHING—High quality, reasonable prices. Free samples, pricelists. Mail-Me-Mimeo, 920 Vanburen, Milwaukee 2.

1000 BUSINESS Cards \$2.95. Job and business printing, samples. Scull's, Dept. C-4, 121 West 25th Avenue, Wildwood, New Jersey.

500 8 $\frac{1}{2}$ x 11 LETTERHEADS \$3.50 Postpaid. Samples free. Gillingham, Milford, Connecticut.

ENVELOPES—#6 $\frac{1}{2}$ Printed, 500, \$2.25; 1000, \$3.75; 2000, \$6.50; f.o.b. Hargraves, Box 517, Corning, N. Y.

100 PRINTED Cards or stationery \$1.00. Postpaid for cash. Opco., 270 Sixth Street, San Francisco 3, Calif.

100 ENVELOPES \$1.00; 250, \$2.00. #10's, \$1.25, \$2.40 Postpaid. Graphic, 556 Beacon, Manchester, New Hampshire.

100 LETTERHEADS Or envelopes \$1.00. Two colors \$1.50. Broadbrook, Botsford, Connecticut.

SUPERIOR Printing. Low prices. Prompt service. Free price list, samples. Southern Printing, Alma, Georgia.

1000 RAISED Printing business cards, \$4.00. Samples free. Simon, 1556 Hoe Avenue, New York 60.

100 ENVELOPES, Printed 2-colors \$1.25. Box 523, Rochester 2, N. Y.

MIMEOGRAPHING—Letters, pricelists, formulas, instructions. Lowest prices. Lem's Letter Shop, 5710 Stanton, Detroit 8.

500 3 $\frac{1}{2}$ x2 $\frac{1}{4}$ FOUR Line gummed stickers 50c. Red border \$1.00. Moritz Printery, Saginaw, Mich.

ATTRACTIVE Labels, stickers. Inexpensive. Samples. Fame, 291 Ellis, San Francisco 2, Calif.

PRINTING OUTFITS AND SUPPLIES

MAKE Your own self-molding rubber stamps and printing cuts. Plexirubber, Argyle 1, Wisconsin.

PRESSES, Supplies, paper. Catalog 10c. Custom, Box 211-P, Springfield, Missouri.

PRESSES, Type, cabinets, supplies. List for stamp. Lincoln Press Company, 220-K Hartwell, Fall River, Mass.

KELSEY Printing equipment. Almost new. Complete shop, \$150 f.o.b. Box #6, Riveredge, N. J.

PRINTING Presses, type, supplies. Lists 3c. Turnbaugh Service, Loysville, Penna.

DO Your own printing. Save money. Simple rules. We supply everything. Print for others; good profit. Raised printing like engraving too. Have home shop. Details free. Kelsey Presses, V-11, Meriden, Connecticut.

MAKE Your own line cuts. Walp, Box 4308-M, Mobile, Alabama.

PATENT ATTORNEYS

BERMAN Lewis Gordon, registered patent attorney. Patent investigations and opinions. Warner Building, Washington 4, D. C.

INVENTORS—If you have a valuable invention, you are advised to authorize a preliminary search through appropriate classes of United States patents. This firm is registered to practice before the patent office and is available to make such search and report to you concerning the probable patentability of your invention. Instructive booklet with "Evidence of Invention" form sent upon request. Victor J. Evans & Co., 931-L Merlin Building, Washington 6, D. C.

INVENTORS—If you believe you have an invention, you should find out how to protect it. The firm of McMorrow, Berman & Davidson with offices in Washington, D. C., is qualified to take the necessary steps for you. Send for copy of our patent booklet "How to Protect Your Invention." We will also send you an "Invention Record" form. No obligation. They are yours for the asking. McMorrow, Berman & Davidson, Registered Patent Attorneys, 134-P Victor Building, Washington 1, D. C.

INVENTORS. Learn how to protect your invention. Unless the inventor is familiar with patent matters, he should engage a competent registered patent attorney or agent to represent him. We are registered to practice before the U.S. Patent Office and prepared to serve you in handling your patent matters. "Patent Guide for the Inventor" containing detailed information concerning patent protection and procedure with "Record of Invention" form will be forwarded to you upon request—with-out obligation. Clarence A. O'Brien & Harvey Jacobson, Registered Patent Attorneys, 41B-K District National Building, Washington, D. C.

INVENTION Record form free and "Patent Information Every Inventor Should Have." Carl Miller, Registered Patent Attorney, Woolworth Building, New York.

REGISTERED Patent attorney offers services. Sanders, 6430 Evans, Chicago 37, Illinois.

"INVENTOR'S Guide" and "Record of Invention" free on request. Frank P. Ledermann, Registered Patent Attorney, 154 Nassau Street, New York City.

PATENTS—Irving L. McCathran, 315 McLachlen Bldg., Washington 1, D. C. Registered Patent Attorney.

PATENTS. "Proof of Invention" free. E. E. Vrooman, Registered Patent Attorney, 507 McKim Building, Washington 5, D. C.

INVENTORS: When you are satisfied that you have invented something of value write me, without obligation, for information as to what steps you should take to secure a patent. Write Patrick D. Beavers, Registered Patent Atty., 935 Columbian Bldg., Washington 1, D. C.

C. A. Snow & Co.—M427, Snow Building, Washington 1, D. C. Registered Patent Attorneys. Write for information.

INVENTORS: Without obligation, write for information explaining the steps you should take to secure a patent. John Randolph, Registered Patent Attorney, 203 Columbian Bldg., Washington 1, D. C.

FOR INVENTORS

INVENTORS: Profit by my experience. Avoid costly mistakes. \$1 may save you hundreds. Send \$1 for booklet "One Inventor's Experience" today. R. E. McLean, 5703 South Benton, Kansas City 30, Mo.

INVENTORS—If you believe you have an invention, you should find out how to protect it. The firm of McMorrow, Berman & Davidson with offices in Washington, D. C., is qualified to take the necessary steps for you. Send for copy of our patent booklet "How to Protect Your Invention." We will also send you an "Invention Record" form. No obligation. They are yours for the asking. McMorrow, Berman & Davidson, Registered Patent Attorneys, 134-M Victor Building, Washington 1, D. C.

INVENTORS: Learn how to protect your invention. Unless the inventor is familiar with patent matters, he should engage a competent registered patent attorney or agent to represent him. We are registered to practice before the U.S. Patent Office and prepared to serve you in handling your patent matters. "Patent Guide for the Inventor" containing detailed information concerning patent protection and procedure with "Record of Invention" form will be forwarded to you upon request—without obligation. Clarence A. O'Brien & Harvey Jacobson, Registered Patent Attorneys, 41A-K District National Building, Washington, D. C.

INVENTORS—This firm is registered to practice before the United States Patent Office and is available to assist you in the preparation and prosecution of your patent application. "Patent Protection for Inventors" booklet containing detailed information and steps to take toward patent protection will be sent upon request. No obligation. Victor J. Evans & Co., 932-L Merlin Building, Washington 5, D.C.

PROFITING From your invention? The International Inventors Club helps you with patents and sales. Membership only \$15 year. Free information. 6614 Metropolitan Station, Los Angeles 55, California.

INVENTORS Take out your own patents. You can quickly learn how to save hundreds of dollars. A short course by this 33-year-old school, for a small fee enables you to get your own patents at any time. Send for Folder No. 33A.C. Western Coaching Bureau, 2588 Mission St., San Francisco 10, Calif.

WAIT—Beware enthusiasm. Save hundreds. Inventions analyzed impersonally. Systematized scientific reasoning method. Find any flaws now. Send idea, problem—\$10.00. Imagineering Analysis, P.O. Box 664, Orlando, Fla.

PATENT Searches, including copies of nearest patents, \$5.00. Reports airmailed within 48 hours. More than 75 registered patent attorneys use my service. For free invention protection forms, write Miss Ann Hastings, P.O. Box 176, Washington 4, D. C.

BECOME Patent firm representative. Spare time, mail order. Experience unnecessary. Work done Washington office, you receive sensational income! Industrial Patent Reports, Box 6296, Washington 15, D. C.

PATENT Searches \$5.00. 48-hour airmail service. Record of invention forms free. Write Patent Engineering Service, 711 14th Street, N. W., Washington 5, D. C.

IF It can be sold patented, unpatented, we can sell it. Free details. Inventors Research, 1154 North Western, Hollywood 29, Calif.

MY Invention paid \$750,000.00. Book "What Inventors Should Know" tells all! \$1.00 refunded if unsatisfactory. Invention record free! Inventor, Box 5B, Omaha, Nebraska.

PATENT Searches \$5.00. 48-hour service. Free record of invention. Write Raymond L. Smith, Patent Searcher, 622 Sheraton Building, Washington 5, D. C.

INVENTION Record form free and "Patent Information Every Inventor Should Have." Carl Miller, Registered Patent Attorney, Woolworth Building, New York.

SEARCHES—Put your patent searches in the hands of a registered patent attorney or agent, as he qualifies to give a worthwhile patentability report. Record of invention form upon request and information on patent protection. Patrick D. Beavers, Registered Patent Attorney, 936 Columbian Bldg., Washington 1, D. C.

INVENTORS: Information on patent procedure furnished on request, without obligation. John Randolph, Registered Patent Attorney, 202 Columbian Building, Washington 1, D. C.

INVENTORS: If you have an invention for sale, patented or unpatented, write Institute of American Inventors, Dept. 40A, 631-E St. N.W., Washington 4, D. C.

"INVENTOR'S Guide" and "Record of Invention" free on request. Frank P. Ledermann, 154 Nassau Street, New York 38, N. Y.

CASH For your idea. 280 manufacturers need inventions, patented or unpatented. List free. Invention Bureau, 208M Clinton, Oak Park, Ill.

COMPLETE Services for inventors. "Record of Invention" form free. Write National Inventors Institute, 4097 East 131st St., Cleveland 5, Ohio.

PATENT Services, \$5, including patent copies. 48-hour airmail service. Invention protection forms free. Patent drawings prepared. Edward Abber, Warner Bldg., Washington 4, D. C.

HELP Yourself! Booklets. Write Gordon MacAdams, Box 595, Garland, Texas.

PATENT Searches, \$5.00, including patent copies. Same reliable search as conducted for patent attorneys. Free protection forms. Fast, accurate service. Patent Service Institute, 945-A Pennsylvania Avenue, Washington 4, D. C.

INVENTORS—Send for free patent information book and inventor's record. Registered Patent Attorney, Associate Examiner, Patent Office 1923-29; Patent Attorney & Advisor, Navy Department 1930-47. Gustave Miller, 94A Warner Building, Washington 4, D. C.

INVENTIONS WANTED

INVENTIONS Wanted; patented, unpatented. Foremost promotion service. Full particulars free. Superior, 338-344 North Rodeo, Beverly Hills, Calif.

MAKE Money! From ideas, gadgets, patents. Information free. Inventors Creative Service, 354 South Spring, Los Angeles 13, Calif.

INVENTORS: If your invention is adaptable to our business we will contract on cash or royalty. If not, we will try to place. Free booklet. Kessler Sales Corporation, 5104, Fremont, Ohio.

MAKE Your ideas pay. If you have a patented invention or copyrighted idea for a marketable product, we invite you to contact us. We are a leading manufacturer of precision products with nationwide sales distribution. Box 112, Brant Beach, New Jersey.

TOY Inventions wanted by manufacturers. On royalty basis. Interested in novel, non-bulky toys of wood or plastic. Contact Kohner Bros., 155 Wooster Street, New York 12, N. Y.

ESTABLISHED Manufacturer wants items to manufacture. Cash or royalty basis. Neecho Small Parts, George I. Richard, Owner Eric, Kansas P.O. Box 102, Phone Eric-318.

INVENTORS Don't sell your invention, patented or unpatented, until you receive our offer. Write Cowgill, Box 298, Marion, Ohio.

INVENTIONS Promoted. Patented or unpatented. Established 1911. Write Adam Fisher Company, 5418 Idaho, St. Louis, Mo.

INVENTIONS Wanted. Patented, pending only. Inventors Patent Exchange, Hartford 1, Conn.

INVENTIONS Wanted. Patented; unpatented. Tremendous manufacturers lists. Global Marketing Service, 1404 Mitchell, Oakland 1, California.

INVENTORS: Hundreds of manufacturers have requested our assistance in locating marketable new products. Complete information free. Institute of American Inventors, Dept. 40-D, 631-E St. N.W., Washington 4, D. C.

INVENTIONS Wanted. Patented or patent pending. 23 years experience promoting inventions. National Service Bureau, 3120 Meramec, St. Louis 18, Mo.

CASH Buyers for ideas and inventions. Write National Inventors Institute, 4097 East 131st St., Cleveland 5, Ohio.

BROKERS With complete service for inventors. The Invention Mart, Spring, Tex.

ATTENTION Inventors! Sell your invention to manufacturers, investors, through the pages of: "Gadgets Patents & Invention News." Write Inventors' Service Bureau, 847 W. Roscoe, Chicago 13, Illinois.

INVENTIONS Promoted since 1931. Jacquelin Harvey, Century Building, Washington 1, D. C.

A New unusual, and proven idea, product, patent, or formula is wanted by national advertising and selling organization to sell throughout U.S. Write Merle V. Watson, Inc., 411 Avalon Place, Peoria, Ill.

ESTABLISHED Manufacturer wants patented or unpatented items to manufacture. Preferably metal products. Write to Frank J. Phillips, P.O. Box 1106, Tryon, N. C.

PATENTS FOR SALE

INVENTORS: Test the commercial value of your patented or unpatented inventions, quickly and inexpensively. Write for free information. Institute of American Inventors, Dept. 40-B, 631-E St. N.W., Washington 4, D. C.

ILLUMINATED Name plates for automobiles. Patents pending. On the order of a parking light, with a name plate attached. Enables the motorist to name his car just as a boat owner names his craft. Paul Freed, 1518 S. Wilton Place, Los Angeles 19, Calif.

MANUFACTURING

WANTED: Mechanical and electronic accessories to manufacture and sell. Aeronautical only. Cash or royalty. Robbins Aviation, 1735 W. Florence Ave., Los Angeles 47, California.

DESIGNING, Development, building. Machinery, inventions, models. Henry, 2136 E. Monmouth, Philadelphia, Pennsylvania.

SMALL Lot manufacturing. Wood, metal, plastics. McKinney, Route 3, Box 144A, Wichita 15, Kansas.

MODELS — Small lot manufacturing. Metals, plastics, etc. Milburn, Burlington, Kentucky.

MODELS, MODEL SUPPLIES

MODEL Makers, experimenters, inventors, gimmick and gadget makers. Precision spur gears, pinions, plates, bearings, shafts, bushings, cams, spacers, mounting posts, etc. Five pound assortment \$3.75 postpaid. Ten pound assortment \$7.50 postpaid. Each assortment contains over 25 gears, plus dozens of small parts. Coilyn Specialties, 5029 Fremont Ave. North, Minneapolis 12, Minnesota.

"TINY Atom" miniature electric motor. For models and toys. Operates from dry cell. \$2.00 postpaid. Ellenby Sales Co., Box 334, Skokie, Ill.

POWER Models. Unusual steam, gasoline and traction engines, fittings, metals. Anniversary catalog 50c. Chas. Cole, Ventura, Calif.

FLEISCHMANN Famous German steam engines \$5.95 to \$85.00 and mechanical ships 79c to \$45.00 postpaid. New catalogue 50c. Merlo, 50-18 94 Street, Elmhurst 73, N. Y.

MODEL Airplanes, engines, railroads, cameras, practically as gifts. Details 10c. Hobbycraft, 104PM, Brooklyn 30, N. Y.

1954 CAR Models. 1/25 scale, all metal, chrome trim. Send for catalog. Cars & Hobbies, Dept. PM-19, 2333 Haddon, Chicago.

BALSA Wood! Top quality! For model aircraft, boats, etc. All sizes. Special offer; free price list. Remaco Balsa, 7 Springfield St., Chicopee, Mass.

BUILD Miniature passenger hauling live steam locomotive with file and drillpress. We do machine work, you bolt it together. Catalog 50c. Little Engines, Wilmington, California.

SHIP And yacht model fittings; blueprints. Send 25c for illustrated catalog listing hundreds of items. A. J. Fisher, 1002-1 Etowah Ave., Royal Oak, Mich.

SHIP And other scale models. Most complete line in New England. Kits, fittings, plans, books, tools, engines, motors. Illustrated catalog 25c. James Bliss & Co., Inc., Dept. SM, 342 Atlantic Ave., Boston 10, Mass.

BALSA Wood. Grade AAA. Free sample, price list. Sig Mfg. Co., Montezuma, Iowa.

10 MICROMODELS \$1.00. List for stamp. Jenid, 558 Loring Station, Minneapolis 3, Minnesota.

SHIP Models and yacht supplies. Complete, large 68 page catalogue 50c. Bill Wild's, 510 East 11 St., New York City 9.

HOME CRAFTSMEN

CHILDREN'S Knockdown platform rocker. Springs, duran, lumber, etc. 100% parts. Make this for Christmas. \$6.75 each. Matching ottoman \$1.00 each p.p. For further information write Carpenter Furniture Co., P.O. Box 1449, Birmingham, Ala.

DOLL House electric light fixtures, inside, outside imported wallpapers. A. Benko, 400 East 66th St., New York 21.

WOODWORKING Craftsmen — Lumber kits. Cut to order. All northern kilndried hardwoods available. We specialize in furnishing rough cut stock to your specifications. Send stock list for your project, large or small. Quotation by return mail. Lumber Specialties Co., Milltown, Wis.

JEWELRY Findings, beads, pearls, jewels! It's profitable, fun! Imported beads, all sizes—shapes. Sample pound \$1.50; 5 pounds \$5.00. Deluxe pearls, high luster, assorted \$2.00 pound; 5 pounds \$7.50. Klondike assorted jewelry findings swept from manufacturer's tables. Parts finished and unfinished for bracelets, pins, earrings, necklaces, chains, rings, etc. Sample pound \$2.00; 5 pounds \$7.50. 1,000 jewels for rings, jewelry—All colors, sizes, \$5.00; 100 for \$1.50. No c.o.d.'s. Satisfaction guaranteed! Merchandise Distributing, 19 East 16th Street, Dept. 111, New York City 3.

FREE "Do-It-Yourself" leathercraft catalog. Tandy Leather Company, Box 791-Q6, Fort Worth, Texas.

PIGURINE Catalog, 1955 edition, 800 illustrated items including Mrs. Helm's paints, enamels; Helen's water color paints, etc., only 35c. Klosterman, Dept. K, 954 Arcade, St. Paul 6, Minnesota.

FINISH Plywood to resemble expensive wrought-iron. Directions plus 18 full size personalized house, lawn sign patterns—complete alphabet, numerals. \$1.00 postpaid. Walker Studio, 218-H, 4343 Lindell, St. Louis 8, Mo.

HARDWOOD Play pens. Standard size. Kit form. Send only \$6.95. Freight collect. Peterson's, Box 402, Huntley, Illinois.

LEATHERCRAFT Pre-cut kits, tools, patterns, instruction books. Stylecraft, Craftool, others. Catalog 10c. Whitman Saddle Mfg. Co., 1725 Powers St., C-10, Cincinnati 23, Ohio.

LIFE Size Santa with pack, 5-ft. pattern. Simple, unique construction directions for achieving life-like appearance. \$1.00 postpaid. Walker Studio, 210-S, 4343 Lindell, St. Louis 8, Mo.

LAMP Size cypress knee, nipple installed \$2.00. Cy Products, Dept. 2R, Lafayette, La.

BOOKLET "Hobbycraft Hints" 10c. Leisure Hour Products, 416 Rose, West Hazleton, Penna.

ALPHABET Patterns. Monograms, numerals. 14 sets 1/2"-4" high. \$1.00 postpaid. Walker Studio, 210-A1, 4343 Lindell, St. Louis 8, Mo.

CRAFT Supplies—Metals, plastic, tools. Helpful catalog. Kale Craft, 2250 Milwaukee, Chicago 47.

LEATHERCRAFT. Tremendous stock of leather, tools, supplies, and kits. In leather business over forty years. Send 10c for big catalog. Sax Bros., 1111 No. 3rd, Dept. PM10, Milwaukee 3, Wisconsin.

16 NEW Lawn chairs, 22 picnic tables, benches, trellises, etc. All 38 plans with necessary full size patterns, \$1.00. Mastercraft 103M, 7041 Olcott, Chicago 31, Ill.

BIG Savings leather—Now, for first time, you can buy full sides of top grain cowhide at our special, amazingly low "tannery-to-you" prices. For details, write Dept. 1, W. D. Byron & Sons, Williamsport, Md. Fine cowhide tanners since 1832.

PLASTICS Home-craft course for men and women. Tells and shows how to make hundreds of fast selling plastics products. All plastics and materials for 23 projects included in course. No special tools needed. Course pays for itself. Write for free booklet. Interstate Training Service, Dept. D-3-K, Portland 13, Oregon.

BIG Full size patterns of Santa, sleigh and reindeer for roof or lawn. Complete directions for making, painting and lighting. \$1.00. Mastercraft, 106M, 7041 Olcott, Chicago 31, Ill.

LEATHERCRAFT. Everything needed by beginners, advanced hobbyists and professional leatherworkers. Largest stock of supplies in U.S. Moderate-priced tooling leathers, top quality calfskins, tools, supplies, kits. Send 10c for big catalog. J. C. Larson Co., 820 S. Tripp, Dept. 4550, Chicago 24.

LEATHERCRAFT. Metal tooling, textile painting, beadcraft, shellcraft, many other crafts. Fun, easy, profitable! Free, big, illustrated catalog. Write today. Kit Kraft, Dept. 260, Hollywood 46, Calif.

WOODWORKING Course for home craftsmen. Twenty-two manuals. Over 1,000 pages. 75 training projects. Only complete home training program available today. Carefully written, profusely illustrated. Covers everything from wood selection to final finishing. Complete instruction in care and use of all hand and power tools. Prepared by expert manual training instructors. Write for free booklet. Interstate Training Service, Dept. G-3-K, Portland 13, Oregon.

BEAUTIFUL Nativity scene. Almost life size patterns of Mary, Christ Child, Joseph, Wisemen, etc. No tracing. Just paste, cut out and paint. Plans for stable also included. Only \$2.00. Mastercraft, 106M, 7041 Olcott, Chicago 31, Illinois.

BUY Wholesale nationally advertised power, hand tools, thousands of other products at big discounts. Free "Wholesale Plan." American Buyers', 628-RR Linden, Buffalo 16, N. Y.

INTRODUCTORY — 2 Kits for only \$1! Special offer, 2 kits only \$1.00 postpaid! 1 moonstone earring kit; 2 gorgeous, genuine rhodium silver pin and earring kit with imported Austrian rhinestones. Also including large, colorful, illustrated catalog which tells how to make earrings, pins, bracelets, necklaces, cuff links, tie bars, barrettes, etc., with imported rhinestones, pearls, and moonstones. Money-back guarantee. Catalog alone, 25c. Address Dept. E-210, Don-Bar Novelty Company, 3511 W. Armitage Ave., Chicago 47, Ill.

LEATHERCRAFT Supplies at lowest prices. "Craftool" stamps. Catalog 10c. Crown Leather, 22 Spruce Street, New York 38.

101 FULL Size patterns. Smart, new, gifts, novelties, lawn figures, shelves, action windmills, alphabets. Plus "Make Money Jig Sawing." Only \$1.00. Mastercraft 106M, 7041 Olcott, Chicago 31, Ill.

METALCRAFT: Complete stock of tools and all the craft metals. Free catalog. Patterson Brothers, 13 Park Row, New York 3, N. Y.

PLYWOOD Panels — Mahogany, cedar, oak, maple, cherry, walnut, pine, birch, Korina. For the first time, direct from manufacturer and priced for "do-it-yourself" or commercial users—5 ply furniture grade, A-A Marine grade, Formica, large or small sizes, 1/2" to 3/8" thick, any quantity. Motor freight delivery to your door. Write for descriptive folder and price list. Southern Plywood Corporation, Dept. M, High Point, N. C.

VIOLINMAKERS, Repairers, amateurs, professionals. Fine tone European wood. Materials, tools, patterns, instructions. Illustrated catalogue 10c. Premier Violin Supplies, Division PVM, 430 South Broadway, Los Angeles 13, California.

LEATHERCRAFT For pleasure and profit. Big new illustrated catalog of leathers, easy-to-make projects, tools accessories, supplies. Send 10c today. Tanart Leathercraft Co., Dept. PM, 149 N. 3rd Street, Philadelphia 6, Penna.

LEATHERCRAFTERS: Everything you need. Catalog 10c. Art Leather, 411 Joseph Ave., Rochester 5, N. Y.

BUILD The patented Little Mint Paper Baler — Slickest little baler for homes, apartments, schools, churches, offices and small businesses. Makes 50 lb. bale. Easy to build. Plans and instructions plus license and name label to build one baler \$2.00 postpaid. Order today, build one for yourself, build others to sell. L. M. Baler Co., Box 125A, Wausau, Wisconsin.

LEATHER, Tools, lacings, supplies. Free catalog. National Handicraft, 199 William St., New York 7.

129 NEW Full size jigsaw patterns. Unusual novelties, gifts, lawn figures up to 22 inches high, action (merry-go-round) windmill, toys, useful gadgets. Artist drawn. \$1. Craftplans, 1321-A South Michigan, Chicago 5.

STYLECRAFT Sure fire hits. "Pre-traced" leather kits. Handbags, billfolds, illigree belts, over fifty other projects. Patterns on leather. Why trace? Just carve, assemble and lace. Large assortment "precarved" kits also available. Send 25c for catalog, free folder. Refunded first order. Apache Leather Company, 2804 E. Washington St., Phoenix, Arizona.

35 LAWN And garden ornament patterns. Full size, ready cut, colors indicated. Only \$1.00. Lincoln Craft Studio, Columbia, Conn.

KNOCKDOWN Cedar chests. Lumber and veneers. Free price list. Giles & Kendall Company, Huntsville, Ala.

FREE Information. Money-making full size patterns. Professional designs. Furniture, gift shop items. Write Jigsaws, 117 Worth, New York 13.

"TOPS" In everything for leathercraft. Lowest prices. Genuine "Craftool" stamps. Catalog 10c. Crown Leather Company, 22 Spruce Street, New York 38.

KNOCKDOWN Cedar chests and lumber. Free price list. Bedford Lumber Company, Shelbyville, Tennessee.

MAKE IT YOURSELF

INFLATE Balloons with lighter-than-air gas. Enjoy fascinating new hobby and unusual sport. Build your own apparatus. Send messages hundreds of miles. Use for target practice. Simple, low cost, easy-to-build. Diagrams, formula, complete instructions. Send \$1. Central Machine Works, Dept. PM, Sioux City, Iowa.

LEVEL For foundations, floors, sewers, contour plowing, any distance, based on principle that water seeks its level. Make this accurate level yourself—save time and money. 50 ft. clear tough vinyl tube .287" o.d. and complete illustrated instructions postpaid \$5.95. Moneyback guarantee. Hydrolevel, 53 DeSoto, Ocean Springs, Mississippi.

BUILD Beautiful two bath fifty foot rancher complete without cash or long term mortgage. Details, illustrated plans \$1.00. Ranch House, Box 281, Dept. 5, Lee, Massachusetts.

SAVE \$7000. For less than \$1/sq.ft. and your spare time you may have this ultra modern brick three bedroom home incorporating the latest construction features. Order set of 3 blueprints and construction details c.o.d. or send \$2 and receive postpaid. Satisfaction guaranteed. Homeplanners Clinic, Box 599, Camas, Wash.

BUILD Your own electric cement mixer. Better than commercial models. Complete illustrated instructions, \$2.00. Bldmore Mfg. Co., Box 281, Lynwood, California.

WROUGHT Iron table legs, 29" V-type \$7.95, freight paid USA. Matching chair frames \$5.95. Dealers wanted. Wroughtcraft, Box 502A, Hialeah, Florida.

YOU Cast metal; balance motors. Free literature. Box 124, Lynwood, California.

PLANS! Used parts build any size garden tractor. Write Allardco, Eland, Wis.

CLOCK Movements — Gorgeous dials, plans, kits. See ad page 265.

BUILD Inexpensive concrete blockmaker. Motor-hand, Also mixer. (Both for less than \$10.) Then make blocks for 5 room house for \$95. Write: C. Lee, Mountain View, Oklahoma.

UPHOLSTERED Chair. Easy to build. NoSag springs. Foam rubber. Costs \$19.50 plus lumber. Sells \$69.50. Complete plans and materials list, \$1.00. Decorator Audrey, 4601 W. North Ave., Milwaukee 8, Wis.

FURNITURE—Wrought iron! You assemble. Low factory prices. Phillips Furniture, East Peoria, Illinois.

CONCRETE Block homes. 32 page booklet on how to build. \$1.00. H. C. Lightfoot, Civil Engineer, Richboro 1, Penna.

WELDERS, Make ornamental iron railings. Instructions \$1.00. J. O'Connor, Milan, Ohio.

A Winco "make-it-yourself" generator saves you 30%. Now you can have electric power when and where you need it and save up to 30% of the cost. How? With a dependable Winco engine-generator you assemble yourself and run off your own engine. Just send us your name and address with 25c and we'll mail you complete plans. Write today to: Wincharger Corporation, Sioux City 2, Iowa.

SEASHELL Jewelry kit complete with instructions. Earring and brooch set \$2.00. Super deluxe kit for miscellaneous jewelry, what-not and novelties \$10.00. Taylor-Craft Shell Kit, 1133 S.W. 9th Rd., Gainesville, Florida.

WOODWORKING Supplies, glue, veneers, plywoods. Catalog free! Minnesota Woodworkers Supply, Box 233, Hopkins, Minnesota.

GEIGER Counter and metal detector kits. Inexpensive, educational. Free literature. Electronic Applications, 5024 Lee Highway, Arlington 7, Va.

HOME Freezer—Build from old refrigerator. Plans \$1.00. Cryder Refrigeration, 31c Mix Ave., Columbus 4, Ohio.

WATCHES, OLD GOLD, JEWELRY

HIGHEST Prices for gold, silver, platinum, diamonds, watches, gold teeth. Satisfaction assured. Goods returned if offer unsatisfactory. United Smelting Works (Old Reliable), 6-B East Monroe, Chicago 3.

WATCH Repairing—Modernized correspondence course. Free information. WatchHealing Institute, Box 34715-A, Los Angeles 34.

HIGHEST Cash for old gold, broken jewelry, gold teeth, watches, diamonds, silverware, spectacles, platinum. Free information. Satisfaction guaranteed. Rose Refiners, Heyworth Bldg., Chicago 2.

WHOLESALE, Retail illustrated jewelry findings catalogue 25c. Refunded with order. Rhinestone Supplies, Box 532EE, Pasadena 8, California.

WATCH Materials: I specialize in close outs. Write Fred Harmon, Box 441, Somerset, Ky.

10 **HIGH-Grade** Swiss ladies' and gents' wristwatches, needing minor repairs, \$18.00. Write for prices. B. Lowe, Holland Bldg., St. Louis 1, Mo.

RHINESTONES, Jewelry settings, cameos, sequins, beads, hobby kits. Send 10c for illustrated catalog. J & M Novelties, Dept. CL-3, Griffith, Indiana.

COSTUME Jewelry supplies. Catalog and samples. 35c. Largest line in America. Milady-Fair Co., G.P.O. Box 1328, New York City 1.

WATCHMAKERS' Journal contains instructive articles on watch repairing. \$1.00 year. Sample copy 20c. Dean Co., Box 3218-M, Daytona Beach, Fla.

WATCH And clock repairing books for hobbyists. Free information. North American, Dept. 14-J, 2320 N. Milwaukee, Chicago 47, Illinois.

MAKE Rhinestone jewelry—No tools needed. Huge profits. Catalog, instructions, sample pin, stones, and color chart of actual rhinestones 50c. Refundable. Bergen Arts, 128M Main, Hackensack, N. J.

GRUEN Watches. Small down payment. Armstrongs, 6 Rockland, Melrose, Mass.

FREE Sample pair of earrings shows you how easy it is to make beautiful costume jewelry. Over 5000 styles listed in new catalog. 25c. Barry's, 188 Ardsley Court, Newark, N. J.

UNREDEEMED Diamond, 1-carat, \$295. 30-day refund. Free catalog. Broff's Diamond Loan Association, 411 Smithfield, Pittsburgh, Penna.

TOBACCO, SMOKERS' SUPPLIES

100 **MAILED** Anywhere \$5.00. Havana blended. Guaranteed. Tampa's Finest Cigars, 406 Grand Central, Tampa, Fla.

PIPE Smokers! Cigar smokers! Free illustrated catalog offers fabulous savings on choice imported and domestic pipes, cigars, tobaccos, supplies. Write Wally Frank, Dept. 1, 150 Nassau St., New York 38, N. Y.

FOR THE HOME

DOORMACK (Pat. applied for) never sold before. Makes your storm door close three times easier by releasing the air that is compressed between the two doors. Also serves as mail door. The perfect gift for the one who has everything. \$4.25. P. W. Cleereman, Newald, Wis.

CHAMOIS, South American wild pig skins. Soft, absorbent. Do not tear or get stiff. Best for washing furniture, windows, automobiles. Two skins for usual price of one. \$1.95 postpaid. Alberta Mills, Johnstown, N. Y.

FOAM Rubber furniture cushions. Factory seconds. 50% discount. Free catalog. Perma-Foam, 140-C Main Street, East Orange, New Jersey.

RAZORS, BLADES, SHARPENING

100 **DOUBLE-Edged** razor blades. Unconditionally guaranteed. \$1.00 prepaid. Regal Sales, Box 8238, Pittsburgh 17, Pennsylvania.

OF INTEREST TO WOMEN

BUTTONHOLE Maker. Fits any sewing machine. Send \$1.00. L. Dentel, Willis, Michigan.

\$40.00 **WEEKLY** At home, perfuming artificial flowers, letters, greetings. Sample Par-Fuma-Grapp 25c. Gifts & Offers, 2127 Williams Ave., Portland, Oregon.

DRESSMAKERS, Sewers, wholesale lists. Dress, suitings, formal fabrics. Box 863, Norwalk, Conn.

KNITTING Yarns wholesale; needles; books; instructions. Free samples. Jeri's Knit, 4300 Hampton Blvd., Norfolk 8, Va.

BEAUTIFUL Ribbon remnants, 100 yards, \$1.00. Dollar Doll Club, free information. Peggy's Doll House, Jefferson City 5, Missouri.

PROFITABLE Home business. Make fast-seller chenille monkey trees, dolls, flowers. Terrific holiday demand. Information free. Velva, Bohemia 16, N. Y.

NYLONS 14c, Anklets 6c, socks 9c, print 17c, panties 12c, dresses 50c, slips 47c, undershirts 17c, robes \$1.65, spreads \$2.65, jewelry \$1.25, watches \$3.50, electric razors \$2.00, aspirin \$1.00—1,000, brushes 9c, razor blades 1 1/2c, pens 8c, combs 1 1/2c. Complete stock list, picture catalogue, 25c. Send immediately. Sibert's, Chattanooga 4, Tennessee.

DRESSES, 24c; Shoes 39c; men's suits, \$4.95; trousers, \$1.20. Better used clothing. Free cat. Transworld, 164-AD Christopher, Brooklyn 12, N. Y.

GROW Mushrooms. Cellar, shed, and outdoors. Spare, full time, year round. We pay \$3.50 lb. We paid Babbitt \$4,165.00 in few weeks. Free book. Washington Mushroom Ind., Dept. 176, 2934 Admiral Way, Seattle, Washington.

MAKE Big money at home! Invisible reweaving pays up to \$10.00 profit in an hour. Make tears, holes disappear from fabrics. Constant demand from laundries, cleaners, homes brings steady earnings. Details free. Fabricon, Dept. C, 8342 S. Prairie, Chicago 19, Illinois.

FOR SALE—MISCELLANEOUS

COVERALLS, Sizes 36-42. \$1.19. Used, reconditioned. Shirts, 49c; pants, 70c. Postage 30c each set. Or c.o.d. Arrow Overall, 5544 Vine St., Philadelphia 3, Penna.

OLD Wall telephones. Working order, oak cabinets, hand crank for ringing. \$5.00 each. Telephone Co., Turtle Lake, Wis.

HEARING Aid batteries, wholesale. Free list. Habs, Box 51, York, Penna.

WANTED—MISCELLANEOUS

WANTED, Mailorder propositions. Write Chang, P.O. Box 531, Bangkok, Thailand.

QUICKSILVER, Sterling, silver solders, precious metals. Wholesale Terminal, Norwood, Massachusetts.

WATCHES, Old gold, silver, jewelry. Write Southern Watches, Gray, Georgia.

SCRAP Mercury (quicksilver) containers supplied—Tantalum, bismuth, tungsten. Metallurgical Products Company. Established 1909. 35th and Moore Sts., Philadelphia 45, Penna.

PERSONAL

COLORADO Springs remains 25c. Violet Turner, 1325 North Wahsatch, Colorado Springs, Colo.

CANADA St. Lawrence Seaway site. Job ads \$1.00. Remains 25c. 5 scenic postcards \$1.00. Box 1025, Cornwall 3, Ontario.

LETTERS Remailed from Harvard, Woodstock, McHenry, Wonder Lake and Ringwood. 5 for \$1. Box Ducey, Ringwood, Illinois.

INTERESTED, Investigate. New York City help wanted columns air mailed to you—\$1.00. Rudge, P.O. Box 995, New York 7, N. Y.

TAMPA Or Rattlesnake postmark, letters remailed, 25c each. Local information, \$1.00. Receiving, forwarding address, \$5.00 monthly. All services confidential. Bert's Services, P.O. Box 665, Tampa 1, Fla.

BORROW By mail from Postal Finance Co. Employed men and women can easily obtain \$50 to \$600 fast, entirely by mail. Repay in small monthly payments. Friends, relatives, employer, tradespeople will not know you are applying for loan. Advise occupation, amount wanted. Postal Finance Co., 200 Keeline Bldg., Dept. TV, Omaha, Nebraska.

SQUARE Peg in round hole? Dissatisfied? Restless? Unhappy? Do psychological tests at home. Uncover true abilities, aptitudes. First time available. Low cost. Details free. Write Psychologic Testing Institute, Dept. 170, 201 N. Wells, Chicago 6, Ill.

WONDERFUL Copenhagen. Air letters remailed 75c. 5 scenic postcards \$1.00. Postbox 1507, Broenshoej, Denmark.

WORMS, Germany, remailing \$1.00. Glaser, 84 N. Clinton Ave., Trenton, N. Y.

DISCOVER Your hidden capabilities! Vocational-aptitude test, complete analysis, \$3.00. Research Institute, Box 650M, North Hollywood, California.

LETTERS Remailed San Francisco postmark, 25c. Private receiving-forwarding address available. Monthly rates. Memo-Mart (PM), Box 3244, San Francisco 19, Calif.

LOCKSMITHS, Your card or letterhead brings the Locksmith News, 2703 E. Third Ave., Denver 8, Colorado.

"**FEMME** Mimics"—Amazing book, containing 375 photographs. About men who wear women's clothing! Free literature. Winco, Dept. PM103, Box 9525, Dallas, Tex.

JAPAN—Letters remailed \$1. Dalevi, 569, 3-chome, Shimo-Meguro, Meguro-ku, Tokyo.

MIAMI Beach, Fla. letters remailed 25 cts. Pronto, P.O. Box 118.

MIAMI, Florida, Letters remailed 25c. 6 for \$1. Tropical Service, Box 471 Riverside Station, Miami, Florida.

LETTERS Remailed 25c, or have mailing-receiving address in Columbus for \$2.00. McLaughlin, 800 Stewart, Columbus 6, Ohio.

HAIRCUT Facts. Booklet 25c. Mastrolia, 32-20CA 89th Street, Jackson Heights 69, New York.

LETTERS Remailed 25c. Any business transacted. Troves, Box 462, Vancouver, Canada.

RESURRECTION On earth—Not heaven. Free! Write: Harvest, Jefferson City, Mo.

"**HOW** Can I find out?" You can! Information confidentially developed. Any matter, person, problem. Worldwide. Officially licensed. Established 1922. William Herman, 170 Broadway, New York City.

LETTERS Remailed 25c. Personal forwarding address. Monthly rates. Hicks Service, Box 1547, Washington 13, D. C.

MEXICAN Law office. Bank references. P.O. Box 41, Juarez, Chih., Mexico.

SEATTLE Confidential Remail letters, 25c. C. H. Bell, Box 91, Enumclaw, Wash.

PORTRAIT in oils. Modern-impressionistic, by the renowned E. John Shay, see Pate magazine advertisement for particulars. Send any photograph. \$25.00 prepaid. P. O. Box 4102, Panorama City, California.

ATLANTA Address. Business, personal. Monthly rates. Atlanta remains 25c; any U. S. city 35c. Foreign rates available. Confidential. Free details. Transamerican, Box 815-A, Atlanta 1, Georgia.

MEXICAN Law. General Practice Attorney, 1203 Arizona St., El Paso, Texas.

MISCELLANEOUS

LEATHERCRAFT For pleasure or profit. Make easy-to-assemble purses, belts, gloves, woolskin toys, 100 other items for gifts or to sell. Send 10c today for big catalog. Largest leathercraft stock in U.S. J. C. Larson Co., 820 S. Tripp, Dept. 4151, Chicago 24.

GAMES, Tricks, puzzles, 1001 hours of fun. 25c. Sanford Sales, 15810 Sanford Ave., Flushing 58, N. Y.

CIGARETTES—Roll 200 guaranteed to please for 75c. Particulars free. Pete Moberly, Box 782, Owensboro, Ky.

BUY Wholesale 450,000 products. Literature free. Carter, Box 6011-D, Chicago 80.

GERMAN Address list—Anything manufactured. \$1.00. Burke Associates, Manchester, Mass.

CLOGGED Drains, cesspools and septic tanks cleaned by new powerful chemical. Sursolvent removes grease, soap, tree roots, etc., without expensive digging and electric rodding machines. No pumping necessary. Mix with water and pour down drain. Free details. Electric Drain Cleaning Co., Boston 34, Mass.

NEW; Complete instant coffee sale, with cream and sugar added. Order 1 or more cases at factory prices f.o.b. New York City. 4 oz., 35c—24 to case; 8 oz., 65c—12 to case. 25% deposit required on all orders. Balance c.o.d. Satisfaction guaranteed. Write for circular or order now. A. T. Baron's Coffee Co., 1579 First Ave., New York City.

GEIGER Counters, metal detectors, ultra-violet mineralights—From \$29.50 up. Write for full information. The Radiac Co., Inc., 489 Fifth Ave., Dept. PM-10, New York 17, N. Y.

TREE Ripened best oranges and grapefruit. From tree to you. Five dollars bushel. f.o.b. Vanderfords, RFD, Pharr, Texas.

SHEET Rock lift; all metal. Foot-proof, 8 ft. ceiling, adjust to 9. \$69.00 f.o.b. Peeteet, Danial & Peeteet, 3509 May St., Ft. Worth, Texas.

KILL Rats, mice, cockroaches, bed bugs, moths, flies, etc. Detailed pamphlet. Professional methods. Satisfaction guaranteed. \$1.00. Western, Box 3055, Madison 4, Wis.

SHRUNKEN Head paperweights. Excellent duplication. \$3.00. Wallace, 614 N. 6th Ave., Phoenix, Ariz.

PROFESSIONAL Debt collector reveals profitable mail technique with sample form for \$1.00. Collector, Box 222, Lake City, Minn.

WRITE For free information. Acreage simplest calculations. Carmean, Hutchinson, Kansas.

BUY Wholesale thousands nationally advertised products at big discount. Free "Wholesale Plan." American Buyers, 631-DD Linden, Buffalo, N. Y.

GEIGER Counter kit. Make your own. All parts and working instructions \$20. Send \$5, balance c.o.d. Dynalec, Box 2502, Denver.

BUY Wholesale cameras, appliances, gift ware. Catalogue 50c (refundable). Dart, 3812 E. Atlantic Avenue, Brooklyn 24, N. Y.

"HOWDY" Cardboard badges for lodges, veterans organizations, Boy Scouts. Sample free. Campbell Products, Urbana, Ill.

SAVE Cash. Swappers read Hoboswap. Thousand offers. Rush quarter. Traders, Alger, Mich.

OVERWEIGHT. Lose pounds, easy, safe. Astounding English diet 25c. Trove, Box 462, Vancouver, Canada.

SMASH Worries, problems with our life-changing "Behavior Control Method." Exciting details free. Applied Christian Psychology, Box 1924-M, Louisville 1, Ky.

FLORIDA County maps—Large detailed showing lakes, streams, roads and trails. Ideal for hunting, fishing, locating property. Send county name and dollar. List free. Godfrey's Map Service, Winter Haven, Fla.

SAVE Over 400% on 10 manufactured tools everyone can use. Send \$1.00. Satisfaction guaranteed. Pacific Tool, Paramus, N. J.

INCREDIBLE! Become mental superman overnight! Free booklet! Bijou, Box 1727-MR, Hollywood 28, California.

FREE Catalog science, educational materials. World Adventure, B4381, Ann Arbor, Michigan.

FREE "Import News Bulletin." Mexican curios. Box 71870, San Diego 7, California.

SCOTTISH Imported ties. Pure wool. All class \$3.50 each postpaid. Send m.o. Ties, Box 1009, Long Beach 1, Calif.

300 BIG Mails guaranteed. Samples, plans, offers, propositions, 12 months listing. \$1.00 refundable. Wright Publications, 2270 Hubbard, Memphis 8, Tenn.

RECEIVE 1300 interesting offers 25c. Satisfaction guaranteed. Mail-Industries, Agua Caliente, Arizona.

FREE. Gadget and home novelty catalog. 180 interesting, useful items. Economy Buyers, 210 Fifth Avenue, New York 10, New York.

NO-Bind shoe cushion tongues. \$1.00 pair. Shoeman, 8304 Burley, Chicago 17.

SOURDOUGH Pot lasts for years. Mix it yourself. Have energy healthfoods, breads, pancakes. Send \$1.00 pkg. Fortyniner sourdough dry starter, Withrow Co., 2805 Colorado, Los Angeles 41, Calif.

TALL Men—6' to 6'11". Free style catalog. Write Ted Thompson, Dept. 107, 6 Green St., Boston 14, Mass.

PHOTO Lamp shades. Scenics or your negatives. For information, write Conaways, Box 7261, San Antonio 10, Texas.

"X-Ray Mind." Stupendous mental power. (Details 10c). Krishnar Institute, Box 842-ST, Escondido, Calif.

GOLD, Silver, metal detectors. Geiger counters for uranium. Mineralights. Sensational new fully guaranteed models. None finer. Information free. Detectron Corp., 3420 Vineland Ave., North Hollywood, California.

SELECTIVE Metal and mineral detector. Revolutionary design. Distinguishes metals from black magnetic sands. Readily detects metals under salt water. Also Geiger counters. Free literature. Gardiner Electronics Company, 2018 N. Dayton, Phoenix, Arizona.

RECEIVE Magazines, samples, catalogues. Mails from everywhere. Offers, hundreds. Get listed 25c. Rortick, Box 86, Cincinnati 28, Ohio.

TREASURE Finders for gold, silver and minerals. Money back guarantee, best available. Also Geiger counters for uranium prospectors, free information. Write Goldak Company, 1541 West Glenoaks, Glendale 1, Calif.

GROW Mushrooms. Cellar, shed, and outdoors. Spare, full time, year round. We pay \$3.50 lb. We paid Babbit \$4,165.00 in few weeks. Free book. Washington Mushroom Ind., Dept. 175, 2934 Admiral Way, Seattle, Washington.

PANNING Gold—Free lesson; catalogue of mining, mineral books, supplies. Old Prospector, Box 729D1, Lodi, Calif.

TREASURE—M-Scope Geiger counters, mineral locators. Why buy something inferior when you can buy the best at a lower price? Backed by years of experience. Fully guaranteed by factory. Detects minerals, metals, gold, silver, coins. Payment plan available. Proven superior performance. Free 16 page illustrated booklet. Fisher Research Lab., Inc., Palo Alto, California.

TANNED Hereford unborn calf hides and tanned sheepskin for dens walls, throw rugs, etc. \$5.00 each. Postage paid if payment with order. Satisfaction or money refunded. Texas Skin Processing Co., 1126 W. Malone Ave., San Antonio, Texas.

UNBELIEVABLY Simple calculating land measuring wheel. Write Carmean, Hutchinson, Kansas.

URANIUM, Gold, silver, treasure. New power-packed, highly sensitive metal detectors and Geiger counters. Kit and factory assembled models from \$34.50. Lightest weight, guaranteed. Free literature. Electronic Applications, 5034 Lee Highway, Arlington 7, Va.

GEIGER Counter tube, gamma, fast-beta. \$7.00 postpaid. Western Radiation Lab., 1107 W. 24th Street, Los Angeles 7, California.

IDEAL Gifts at popular prices. Send for free circular showing our line of guaranteed men's jewelry. General Crafts, Coventry, Rhode Island.

URANIUM - SCOPE

Here is a precision built optical instrument used to detect radioactivity from Uranium Ores. This is one of the most sensitive detectors of natural radioactivity, without investing in costly electronic equipment. This instrument is made of sturdy, protected aluminum, with precision optical parts, to give it unlimited durability in the field and laboratory use. URANIUM-SCOPE is furnished with Uranium ore sample and packed in attractive box.

Send Check or Money Order — No C.O.D.'s
KOSCO, INC OF CALIFORNIA
Dept. P3110 Suite 110 Tolman Bldg., 3460 Wilshire Blvd.
Los Angeles 5, Calif.
*Dealers and Agents Wanted



ONLY
\$395
POST PAID

See the
Bombardment
of the
Atom!
A
Scientific
and
Educational
Gift
for All.

Sportrailer

**Deluxe
Camp
Home**



2 rooms, each 6'x7'4" in 2 min. Complete with 2 beds, springs, mattresses. 2 folding chairs, folding cabinet and table, gas bottle, 2-burner stove, floor furnace. 40 cu. ft. storage space in forward compartment and under beds. Room for 2 extra beds on lower level. Screened and zippered canvas erects automatically with lifting of counter-balanced lid. Boat or game can be carried on top deck. Circular on request.



SPORTRAILER MFG. CO.
Stephenson Bldg.
Detroit 2, Mich.

DO IT YOURSELF — Give Your Car A

DYNAMIC OVERHAUL

- STOP BURNING OIL!
- GET MORE MILES PER GAL.!
- QUICKER STARTING!
- GET NEW CAR POWER!

An amazing compound in "Dynamic Overhaul" re-plates the pistons, piston rings and cylinder walls—so your motor stops burning oil and excess gasoline. Stops piston slap! You can actually feel the surge of new car power. Just squeeze "Dynamic Overhaul" on top of each piston through the spark plug openings.

INCREASE COMPRESSION

Make your own test without risk. When your cylinder walls and pistons are treated with "Dynamic Overhaul," test the compression. The increase will astonish you. Your money back if not completely satisfied!

SAVE \$50.00 TO \$150.00 REPAIR BILL



MAIL THIS COUPON—TODAY!

IMPERIAL PRODUCTS CO., Dept. 10
Box 66, Rockford, Ill.

Rush me "Dynamic Overhaul." If I'm not absolutely convinced that I get reduced oil consumption and more mileage after "Dynamic Overhaul" is used as directed, I will return the empty tube within 30 days or after 400 miles and my FULL PURCHASE PRICE WILL BE REFUNDED.

6 Cylinder Car 8 Cylinder Car
\$3.95 Enclosed (postpaid) Send C.O.D. (plus postage)

Also send FREE amazing new powder polish to restore the original appearance to my car.

NAME _____

ADDRESS _____

HAND HYDRAULIC PUMP

Single or double designs to 20,000 PSI



With or without reservoir. Standard reservoirs 70, 160, 910 cu. in. capacity. Interchangeable pistons $\frac{3}{8}$ - $\frac{1}{2}$ - $\frac{3}{4}$ inch, 1 inch piston (special) $\frac{1}{4}$ " N.P.T. Pipe connection. 18" handle. Unit can be bolted or welded in position.

Can be used on hydraulic test stand, to actuate hydraulic cylinders, jigs, fixtures, as booster in hydraulic system. All pumps have release screw to relieve system. All steel construction.

SEND TODAY FOR FREE DESCRIPTIVE LITERATURE AND PRICE LIST.

WILLIAM S. PINE

1635 E. 22nd St. Los Angeles 11, Calif.

LEARN TV in KG

FAMOUS FOR 24 YEARS

1,000's OF SUCCESSFUL GRADS COAST TO COAST



Easy, quick, fascinating. Learn TELEVISION in 36 short weeks of enjoyable companionship in shop training. Wonderful job opportunities. Graduates have choice of many jobs or can establish their own TV repair shop. YOU CAN START EARNING AS MUCH AS \$150 PER WEEK. NO limit as time goes on. U.T.S. is an old established school (TV exclusive for 24 years) staffed by expert instructors, headed by one of America's first TV broadcasters. Costs so little to prepare yourself for life. No previous experience needed. Fully approved for Korean Veterans. Also fully approved course in color TV (first in U.S.A.). Get the full story today.

WRITE for FREE Booklet

UNIVERSAL TV SCHOOL

1228M Admiral Blvd. Kansas City, Mo.

FREE CATALOG



BUILD 15 RADIOS
AT HOME WITH THE PROGRESSIVE
RADIO "EDU-KIT"

ONLY **\$19⁹⁵** COMPLETE

All Parts, Instructions, Soldering Iron, Tester Included. Money Back Guarantee.
PROGRESSIVE "EDU-KITS" INC.
Dept. PM-522, 497 Union Ave., Brooklyn 11, N.Y.

PROGRESSIVE "EDU-KITS" INC.

Dept. PM-522, 497 Union Ave., Brooklyn 11, N.Y.

RUSH ME THE FOLLOWING:

- Free Descriptive Literature—No Obligation.
 Free Valuable Radio and TV Guides—No Obligation.

Name _____

Address _____

City _____ Zone _____ State _____

MAKE YOUR OWN
FOLDING TABLES
IN MINUTES...
AND SAVE MONEY!

WITH TABLECRAFTERS'
TUBULAR STEEL
FOLDING TABLE LEGS



You simply screw leg assemblies to your table top. They're sturdy and rustproof. Won't collapse...yet fold easily for storage. For banquet, buffet, hobby, work and game tables.

COMPLETE KIT **\$995**
FOR ONE TABLE

Send check or money order and we'll pay postage.

ATTENTION!

SHOW THIS AD TO THE COMMITTEE OF YOUR CHURCH, LODGE OR OTHER ORGANIZATIONS. THEY'RE ENTITLED TO SPECIAL DISCOUNTS.

TABLECRAFTERS Dept. A-4
6713 CASTOR AVE., PHILA., PA.

Men's **EGYPTIAN** "Goddess of Luck" RING

Set With Large, Genuine **2 CARAT ZIRCON**

LOOKS LIKE \$1000.00 GENUINE DIAMOND

Worn by hundreds with the belief it brings good luck, success, good health. Beautifully designed. Send no money—Pay postage plus 10% Fed. Tax. If not delighted return in 5 days—MONEY-BACK GUARANTEE.

IV 7/306 14 E. Tellow Blvd - Bal Pk
S & K ZIRCON COMPANY
347 COTTAGE AVENUE, BALTIMORE 13, MARYLAND

PAY ONLY \$4.50

HELPFUL BOOKS

Send post card asking for FREE catalog

Popular Mechanics Press, 200 E. Ontario, Dept. 601, Chicago 11

SEND ME

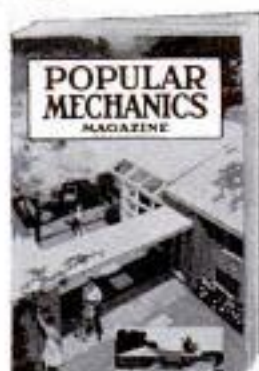

every month so I am sure to see each new issue. Here's

- \$3.50 for 1 year
 \$8.00 for 3 years

name _____

address _____

city _____ zone _____ state _____ B-104

Hand this order to your newsdealer or send it to

POPULAR MECHANICS
200 East Ontario St. Chicago 11, Ill.

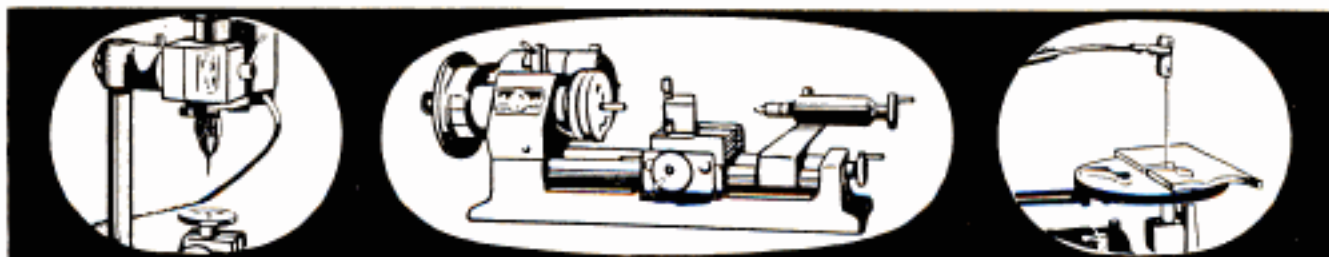

8 PRECISION TOOLS IN ONE! UNIVERSAL MACHINE—"THE UNIMAT"

A high precision, powerful, variable speed **LATHE** for metal, wood, plastics, etc. Sturdily built, compact, micro-controls! Ideal for machinists, model and tool makers, jewelers, hobbyists. This Universal Machine is made for the small precision job! Attachments quickly convert the **UNIMAT** into a **TABLE SAW**, in less than a minute! Also, **DRILL PRESS** (with Jacobs-like chuck), **SURFACE GRINDER**, **MILL, SANDER, SCREW CUTTER** and **PORTABLE HAND DRILL** can be set up with the **UNIMAT** in a matter of minutes and each conversion is a precision tool with variable speed adjustment!

PRECISION

The **UNIMAT** is not a toy or a cheaply

made gadget for quick sales; the **UNIMAT** is finely made of the best steel, sturdily built, precisely made for precision professional tooling. Made to last indefinitely, yet the price is so low you will be pleasantly surprised!

ADAPTABILITY

The **UNIMAT** is a highly versatile and adaptable machine for practically every type of small precision tool work and can be converted in a matter of minutes into **8 DIFFERENT MACHINES!** The **UNIMAT** is a bench-type machine with motor and speed changer included! Nine speed changes! Comes in handsome wood chest! Occupies little room; ideal for machinist,

model maker, tool designer, hobbyist, etc. You get 8 excellent machines for **LESS** than the price of one!

LITERATURE FREE

The **UNIMAT** is a terrific tool at a very low price. If you appreciate good machinery you'll love the **UNIMAT**. Easy terms. Old machinery accepted in trade. Literature and valuable **MACHINIST'S GUIDE** free! Be sure to mention, **UNIMAT**.

PLASTICAST CO. (Dept. CU)

(WRITE TO EITHER ADDRESS)
P.O. Box 6737 Chicago 80, Ill. P.O. Box 987 Palo Alto, Calif.

FREE AMAZING NEW BOOK "HOW TO ANSWER ADS"



Never before have you seen anything like this. Tells you in simple language the correct way to answer ads. Gets you quicker replies—better results, and greater satisfaction. Will save you time and money and it's **ABSOLUTELY FREE**. No obligation whatever. Every reader of advertising should have this booklet. Send a postcard for your copy NOW. **F. W. JOHNSON**, Popular Mechanics Magazine, Room 600-A, 204 East Ontario Street, Chicago 11, Ill.



TRAILER COACHES

Here's everything you want to know about trailers, with plenty of pictures and plans and instructions for building three different types. Covers also, history of trailers, trailer parks, camps and overnight-stops information, furniture, furnishings, materials and engineering data. If you want to build a trailer, live in a trailer, or just want to know more about trailers, get this book. Now only 75c postpaid. Rush order to:

POPULAR MECHANICS PRESS • Dept. 350, 200 E. Ontario St., Chicago

Build it Yourself!

Complete Trailer Book and Construction Data for 10, 16 and 22 Foot Trailers — Now 75c

Partial Contents

Trailer Parks—Living in a Trailer—Towing a Trailer—Floor Plans—Service—Classifications—Balance—Dollies—Jacks—Weight Distribution—Construction—Working Drawings for a Two-Place, Standard Travel and Standard Dwelling Trailers. Size 8½x11¼ inches.

HELPFUL BOOKS

Send post card asking for **FREE** catalog

Popular Mechanics Press, 200 E. Ontario, Dept. 601, Chicago 11

30 POWER! WHISPER WEIGHT 8½ OUNCES

Newest Pocket Telescope engineered for **UNITED** to give you sharper, clearer, crisper images and smooth, easy-sliding focusing action. Use indoors, outdoor, vacationing, trips, closeup and long distance viewing. 2" closed, 14½" extended. **\$9.95** **TAX FREE**

NOT A CHEAPLY MADE TOY TELESCOPE. But a precision, all metal, chrome trimmed automatic masterpiece. Interiors of **VITAL** first Achromatics are **COATED** assuring needle sharp viewing! Price includes handsome carrying case. Made in Japan. **UNCONDITIONALLY GUARANTEED**. Try for 30 days. If not satisfied return for immediate refund. Cash orders postpaid. C.O.D.'s require \$2.00 deposit. **UNITED BINOCULAR CO.**, 9043 S. Western, Dept. C-8208, Chicago 20. **DEALERS WANTED.**

OIL FILTER REFILLS . . . 10c

Here's News! Ordinary toilet paper makes an ideal oil filter. Laboratory tests prove it cleans oil faster and better than popular makes of filter elements. All you need is a simple set of Retlif Adapter Plates . . . and you can start using toilet paper rolls (costing about 10c) in your present oil filter. For proof and descriptive literature, send name and address to:

RETLIF CORP., Dept. 129, 1239 No. Highland Ave., Los Angeles 38, Calif.

WHOLESALE TOOL CATALOG
UP TO 50% OFF

MAKE EXTRA MONEY

Start Your Own Business

Sell tools part time, full time. Save money for your industrial and institutional use. **A MILLION DOLLAR INVENTORY AT YOUR FINGERTIPS!** Stanley, Millers Falls, Plumb, Diston, Wiss, & other Nationally advertised tools up to 50% discount.

No Investment Required. Send \$1 Deposit for Dealers Card and mammoth wholesale catalog. \$1 refunded on first purchase or returned if you are not 100% satisfied.

SILVO HARDWARE CO., Dept. PM, 108 Market St., Phila. 6, Pa.



TESTS LIVE OR DEAD CIRCUITS UP TO 600 VOLTS!

NEW Desco CIRCUITRACER—thousands in use—by Auto-Lite, Bendix, General Electric, electricians, servicemen. For all electrical, Hi-Fi, radio-TV, automotive, aircraft, marine. Locates grounds, opens, shorts. Tests tube filaments; plates, screens; vibrators, output voltages. Ind. AC or DC. Ind. through 20 megohms res. Tests your wiring before you apply power. Kit includes incand. signal light, neon lamp, batteries, 12-pg book "Tracer Tips." Rugged lifetime const. Ironclad money-back guarantee.

COMPLETE KIT \$4.95 POSTPAID
Does job of instruments from \$15 to \$50

Circuitracer
DESCO MFG. CO., 601A E. WALNUT, PASADENA 1, CALIF.

ORDER BY MAIL—FOR C.O.D. ENCLOSE DEPOSIT OF \$1.00



POPULAR MECHANICS

FAMOUS LITTLE LIBRARY OF USEFUL INFORMATION

Complete Set of 126 BOOKS only \$17.95

25 BOOKS	\$3.75
12 BOOKS	\$2.00
5 BOOKS	\$1.00

SINGLE BOOK 25c

Here at amazingly low cost is the practical help and information you have always wanted. Articles in previous issues of Popular Mechanics have been classified according to subject and are now available in these handy reprint booklets.

Check titles wanted, clip ad, mail today.

HOME WORKSHOP

Power-Driven Saws—74: How to build. Drill Presses, Plane, Grinders—79. Sanders—80: Details on 8 machines. Wood & Metal-Turning Lathes—81. Filing Machine, Hack Saw, Cutoff Wheel, Shaper—82: Full details on these. Metal Lathe Tools—101: How to build. Workbenches and Tool Cabinets—47. Spray Painting—84: Proper methods. From Pattern to Casting—91: How castings are made in sand molds. How to Use a Circular Saw—135. Jigsaw Technique—136: How to use. Bandsaw Know-How—137: Techniques.

HOME IMPROVEMENTS

Painting Your House Inside and Out—117. Simple Home Improvements—104: Save money. Building Extra Rooms in Your Attic—23: Add to the value of your home. Basement Playrooms—24: Build an attractive playroom in your basement. House Wiring—89: How-to-do-it. Curing Leaky Basements—45. Fitting Home Game Room—55. Built-in Fixtures—78: Several. Lower Your Fuel Cost—31: Practical hints that will save you hundreds of dollars. Hanging Wallpaper—38: Hints and tricks. Ridding the Home of Insect Pests—107. Constructing Indoor & Outdoor Fireplaces—88: Details on stone fireplaces.

CRAFTWORK • HOBBIES

Games and Puzzles—131: Have fun at home. Model Planes You Can Build—129: Several. Fun With Your Model Railroad—127. How to Make Novelty Jewelry—126. Working with Plastics—61: Novelties, etc. 25 Shelves You Can Make—64: Wall shelves, etc. Novelties Turned on Lathe—62: Dishes, etc. Projects in Plastics—112: How to use. Inlay Pictures—Veneering—63. Whittling and Wood Carving—65: Methods. Action Toys—66: 21 easy-to-make toys. Marionettes—113: How to make and use. High Flying Kites—67: How to build. Windmills & Weather-vanes—68. Lamps in Wood, Metal, Plastic—69: Several. Bows and Crossbows—115: How to make. Playground Equipment—73: 8 projects. Metal Craft—28: Simple instructions. Weaving and Re-caning—37: Full details. Gem Cutting—42: How to cut and polish.

USING TOOLS

How to Use Your Drill Press—125. Correct Measurements—106: How to obtain.

Tool and Saw Sharpening—92: Tricks and hints. Technique of Using Drills and Wood Bits—90. Successful Wood Turning—32. How to Read Blueprints—71: Tells you how. Metal Turning Lathe Kinks—99. Operating a Metal Turning Lathe—100. Heat Treating and Case Hardening—102. Working with Glass—103: Cutting, etc. Using Basic Tools—120: Tips and hints.

WELDING • SOLDERING

Rewinding & Servicing Electrical Motors—75: Repairing and rewinding motors. Electrical Appliances, How to Fix—111. Electromagnets & Solenoids—44. Transformer Construction—41: Directions. The Boy Electrician—43: Five projects. Soldering & Brazing—17: Tells how to. Arc & Spot Welders—5: How to use & build. Build Your Own Relays—123: Instructions. Home Burglar Alarms, Secret Locks and Time-Setting Systems—128. Welding with Arc and Gas—134: Tips.

AUTOMOBILE BOOKS

House Trailers—121: Build it yourself. Automobile Kinks and Shortcuts—10. Building Trailers—Small Teardrop and Utility—27: Can be built in your spare time. Motor-Driven Midget Car & Scooter—34. Curing Auto Electrical Troubles—95.

BUILD A BOAT

14 Ft. Outboard Runabout—2: How to build. Rowboats, Bicycle Boat, Small Dinghy—83. Small Sail Boats—84: For young sailors. Two Outboard Runabouts—85: 14 ft. & 12 ft. Build Your Own Canoe, Kayak, Surfboard—30: Complete building details. Fast Class-E Ice Yacht—22: Build your own.

GARDENING HELPS

Lawn and Garden Equipment—124. Handy Farm Implements—114: How to build. Tractor Attachments—116. Backyard Gardening—39: Helpful hints. Lawn & Garden Novelties—72: Easy to build. Trellises, Pergolas, Fences—76. Lawn & Garden Furniture—77. Colored Concrete Garden Furniture—6. Farm & Garden Tractors—8: How to build.

PHOTOGRAPHY

Home Movie Equipment—118: How to use. Photo Lighting—119: Helpful information. Photo Enlargers—1: Complete plans. Photo Printers & Dryer—25: Describes three. Photo Darkroom Equipment—96. Picture Projector, Trick & Table Top Photography—97: Tips on how to make. Photo Kinks—98: Money-saving ideas.

FURNITURE MAKING

Furniture Upholstery and Repair—122. Rustic Furniture—18: How to build. Children's Room Furniture—51. Book Ends—52: Good selection from 10 designs. Small Tables—54: Interesting styles. Desks—53: Many varied designs. Smoking Stands—56: Seven designs given. Plain & Novelty Wood Finishing—40. Book Cases—59: Eight designs. Magazine Racks—49: Ten attractive racks. Clock Cases—50: Several types. Serving Trays for Every Occasion—53.

MISCELLANEOUS

Cleaning Formulas—11: Make your own. Re-Silvering Mirrors—70: How to do it. How to Build a Concrete Block Machine—110: Make your own block machine. It's Easy to Tie Knots—105. Chemical Experiments—93: Several. Taxidermy—9: How to mount small animals. Log Cabins and Tourist Cottages—14. Magic for Everybody—29: Simple tricks. Trapping Small Animals—33: How to trap. Training Your Dog—35: Tricks and obedience. Small Furnaces—36: For melting copper, etc. Electroplating with Copper, Nickel, Chromium, Lead, Zinc, Cadmium—86. Plating Non-Metallic Objects—Plating with Gold, Silver, Alloys—87. Telescopes—20: Design and construction. Poultry Houses—108: How to build. Guns & Decoys—109: Clean guns, make decoys. For Better Business—130: Timely tips. For Better Business—132: Saves time. For Better Business—133: For smooth operation.

USE THIS HANDY ORDER COUPON NOW!

POPULAR MECHANICS PRESS
200 E. Ontario St., Chicago 11, Ill.
I enclose \$_____ (U.S. currency may be mailed if carefully wrapped) for "Little Library" booklets numbers:

24 Books	12 Books	5 Books	1 Book
\$3.75	\$2.00	\$1.00	25c

--	--	--	--	--	--	--	--	--	--

NAME _____

ADDRESS _____

CITY _____ ZONE _____ STATE _____

FINE WORK CLOTHES
AT LESS THAN
1/3 COST!
STERILIZED, CLEAN-AS-NEW

Surplus Stock. Terrific Values!



PANTS Worth \$3.95 new!
You get 4 used pairs for less than the price of 1 new pair! Navy or green. Send waist and inside leg measurements.

99c
4 for \$3.75

SHIRTS to Match. (Made to sell for \$2.99). 4 for the price of 1! Sturdy fabrics for long tough wear. Send neck size.

79c
4 for \$2.99

COVERALLS. Made to sell for \$5.95. Yours for less than 1/3! Send chest measurement.

\$1.95
3 for \$5.45

MONEY BACK GUARANTEE If you're not convinced these are terrific bargains, return 'em within 10 days for full refund. Order today. C.O.D., or send money and we'll pay postage.

TRU VALU SALES CO. Dept. PM-10 1294 E. 9th St. Cleveland 14, Ohio

Needed on Every Automobile
AUTOMATIC OIL RESERVOIR



You Cannot Forget to Check Your Oil—This Unit Does it For You

Safe check on your engine. Reserve quart of oil is poured into full crankcase thru regular filler opening and is picked up by the unit. As engine uses oil, the unit replaces it. Dash light warns when reserve is used. Then another quart is added to crankcase and cycle repeats. Do not let your engine oil get dangerously low. Nothing to forget, fully automatic. **SEND NAME, YEAR, MODEL OF CAR WHEN ORDERING.**

Standard Model \$17.95
DeLuxe Model 19.95
Special DeLuxe Model 24.95
Truck Standard Model 19.95
Truck DeLuxe Model (2 qt. capacity) 24.95

Bests and other engines, write for quotations. Send cash with order, save C.O.D. charges. Satisfaction guaranteed.

AUTOMATIC OIL RESERVOIR CO.

DEPT. PM-10 POST OFFICE BOX 538 OAKLAWN, ILL.

Say You Saw It in Popular Mechanics

AIRPLANE WHEEL ASSEMBLIES



These wheel assemblies are all new, and of heavy duty construction. Depending on load desired to carry, they are ideal for House Movers, Farms, Trailers, Carts, Wheelbarrows, etc.

Complete with Wheel, Tire, Tube and Bearings

Size 26-00, 10 ply tire, smooth tread, uses tapered axle size 3 in. x 2 1/4 in. 10 1/2 in. wide. Overall height 26 in. Static Load 6,300 lbs. Weight 54 lbs., Price \$47.50 ea.

Size 8-00x4, 6 ply, smooth tread. Uses straight 5/8 in. axle. 3 1/4 in. wide. Overall height 13 in. Static Load 1,800 lbs. Weight 8 lbs., Price \$12.50 ea.

Size 6 x 2 1/2, solid rubber tire, heavy duty roller bearing, 6" high, 2 1/2" wide, 1" straight axle, static load 500 lbs. Weight 4 lbs., Price \$3.50 ea.

Prices F.O.B. Chicago. Include approx. postage on orders paid for in advance. C.O.D. orders enclose 25% balance sent C.O.D.

Size 17-00, 6 ply, smooth tread. Uses tapered axle, size 2 in. x 1 3/4 in. 8 in. wide. Overall height 17 in. Static Load 2,000 lbs. Weight 18 lbs., Price \$17.50 ea.

Size 8-00x4, 4 ply, smooth tread—uses straight 1 1/2 in. axle, 6 in. wide. Overall height 17 in. Static Load 900 lbs. Weight 13 lbs., Price \$27.50 ea.

Size 10 1/2 x 4, 6 ply ribbed tire. Uses straight 5/8 in. axle, 3 1/4 in. wide. Overall height 10 1/2 in. Static Load 1,200 lbs. Weight 8 lbs., Price \$9.95 ea.

U. A. S. Corp. Dept. PM-10, 5637 W. 63rd Pl. Chicago 38, Illinois

THE BIG TV SECRET IS OUT!

Make \$50 an Hour
Every TV Owner
A Prospect!



ANY TV PICTURE INSTANTLY CHANGED TO AMAZING "ELECTRON-BLENDOR" RECEPTION

Now "cash-in" with the most sensational TV development since Television itself! NU-VU, the amazing new "electron-Blendor" Screen brings clear, bright, glareless, lineless pictures to every TV set. No TV owner has ever seen a picture equal in clarity, blended tone or depth to the one YOU WILL SHOW with NU-VU! Your demonstration takes only a minute! You make up to \$7.80 profit each sale! Millions of TV owners are prospects... every one a money making prospect for you! No mechanical or electrical installation! The instant NU-VU is in place your customer receives the finest picture ever! Unconditionally guaranteed! Mail the coupon below for your demonstrator and full money-making details... do it today!

EASES EYE STRAIN

Leading medical authorities approve NU-VU for its restful effect on the eyes.

INSTALL IN 1 MINUTE

Even a child can install NU-VU. No tools needed. Shockproof, fireproof, easy to clean!

MONEY BACK GUARANTEE

Money Back if not 100% pleased!
Distributors! Write for territory and quantity prices!
Make Huge Profits on Every Sale!

NU-VU Corp. Dept. P64
913 Rush St., Chicago 11, Ill.

Rush my personal NU-VU demonstrator (list price \$9.95) and free "big profit" information. I enclose \$7.50.
 Rush distributors deal and low quantity prices.

Name _____
Address _____
City _____ Zone _____ State _____



ALSYNITE, the original translucent fiberglass panel. Easy to use as plywood... can be sawed and nailed... shatterproof and feather-light. Installs with ordinary hand tools. Available in 20 decorator colors. Perfect for partitions, awnings, shower stalls, ceilings, carports.

FREE
"Do it yourself"
FOLDER

ALSYNITE COMPANY OF AMERICA
Dept. PM-A, San Diego 9, Calif.
Send free Do-It-Yourself folder to:

NAME _____
ADDRESS _____
CITY _____
STATE _____

Plants in California, Ohio and New Jersey

FREE SAMPLE OF FLOK-KRAFT Suede Paint

LAMPS and FABULOUS HOME PROFIT PLAN!

SHOES, RADIOS, JEWELRY SILVERWARE CABINETS, TURN TABLES

"MAKE \$5 to \$10 per hour at home! FLOK-KRAFTERS needed in every city, town and village"

LEARN IN A FEW DAYS THROUGH PROVED, TESTED METHODS - Start right away to make more money with this AMAZING MIRACLE FINISH that gives a velvety, luxurious surface to radios, lamps, toys, signs, store displays, figurines, auto dashboards and trunks - hundreds, yes, even thousands of items, including walls and ceilings of rooms. Free profit plan offers everything needed to start at once.

GRASP THIS OPPORTUNITY TODAY. This is too good to miss. Investigate in the privacy of your own home. Get your FREE SAMPLE and full details, including your FREE home business plan now... Be first in your community to cash in on this huge new market. WRITE NOW-SEND NO MONEY. COAST INDUSTRIES, Dept. 2B, 1006 So. Los Angeles St., Los Angeles 15, Calif.

NELS IRWIN
Director of Inspection

STOP CHANGING MOTOR OIL!

End this needless expense forever with

RECLAIMO Today's most advanced OIL RE-REFINING filter FOR CARS, TRUCKS, TRACTORS.

Continuously cleans and RE-REFINES motor oil as you drive by utilizing motor heat - keeps oil in high grade lubricating condition at all times.

"RECLAIMO"

- REMOVES SOLIDS (by filtration)
- REMOVES WATER (by distillation)
- PREVENTS Excess fuel dilution
- PREVENTS Acid and Sludge Formation
- ADDS Thousands of Miles to Engine Life

MAINTAINS Stable Viscosity ELIMINATES All Oil Changes FREE 32-page book "OIL FACTS" with bonafide \$1,000.00 offer on page 30. Gives you the complete "Reclaimo" story and details of our extraordinary 90-DAY NO-RISK TRIAL OFFER. Write for your copy today!

RECLAIMO MFG. CO.
5083 Elston Ave., Dept. M-10, Chicago 30, Ill.
Wm. Schwalge, U.S. Pat. 1757223, 1834654, 2068473.

DEALERS WANTED

U. S. BUREAU OF STANDARDS, Bul. 86 States, "Oil does not wear out mechanically."

\$1 Sensational TIRE Special \$1

THINK OF IT! Just \$1.00 buys an extra, SUPER MILEAGE passenger tire (any size when you order 2 SUPER MILEAGE pass. tires (any size) at only \$5 each. Limited offer! Act quickly!

WHITEWALLS \$1.00 ea. EXTRA.

FREE TUBE WITH EACH TIRE! EVERY TIRE FULLY GUARANTEED!

GOLDEN RULE 32 MONTH GUARANTEE BOND WITH EVERY TIRE!

SUPER MILEAGE TRUCK TIRE BARGAINS!

700-15(5)	\$8.00	650-20	\$10.02	1000-20	\$18.42
750-14(8)	9.00	700-20(10)	11.95	1100-20	19.12
700-17	9.00	750-20(8)	12.80	1200-20	27.02
750-17	10.70	700-20(10)	15.25	1000-22	19.72
825-15	23.72	825-20	18.50	1100-22	20.42
600-20	8.00	900-20	17.92	1100-24	23.22

Military Mud-Sno Treads-Super Mileage Specials!
Std. Guer. 16 Mos. | 750-20 Std. \$12.55 | 900-16 Std. \$12.95
Rugged Guer. 36 Mos. | 750-20 Rg. 16.05 | 900-16 Rg. 16.00

WINTER MUD-SNO PASS. TIRES, any size—\$9.95 ea.
FOR RUSH SHIPMENT send check or Money Order!

JAYDEE TIRE CO. 2236 N. FRANKLIN STREET, PHILA 33, PA. (Dept. PM)

MAKE A "Stradivarius" VIOLIN

—For Pleasure
—For Profit
—For Your Own Use

BOOK AND PLANS ALL YOU NEED

You Can Do It at Little Cost! It's Easy! It's Fun!

Here is the "top" of all home crafts projects. Make a violin—a replica of a famous "Strad"—the original of which sold for \$80,000.00. Joe Held who has made hundreds of fine violins makes the job so easy—so inexpensive—in his new book "You Can Make a 'Stradivarius' Violin." You don't need any tools. Held shows you how to make all the tools you need from old table knives, worn out files, sheet metal, etc. Eight full-size plans, 16x23 inches, folded into the book give you every detail in actual size.

Violins Bring High Prices

Make a violin and you probably will never want to sell it. But good tone modern violins bring terrific prices, yet the materials cost comparatively little. With Held's plans and step-by-step instructions you can make such a violin for yourself. 15 chapters guide you in selection of wood, fashioning the belly, back, sides, mold, lining, neck, scroll, purfling. Other chapters cover varnishing, finishing, stringing. Others show how to make tools and clamps at little or no cost.

Order Book Today. Money Back if Not Satisfied.

Make your own violin for pleasure or profit. Get book and plans now. Clip this ad and mail with check, money order or cash for only \$5.50 or we will ship C.O.D. Money back in 7 days if not satisfied.

FULL SCALE PLANS INCLUDED

Working plans, drawn to full scale, are included in a special pocket inside the book where they may be withdrawn for quick and easy reference.

POPULAR MECHANICS PRESS

\$3.50 Cloth Bound ORDER FORM IN BACK
Dept. 30
200 E. Ontario St., Chicago

You trace or work direct from actual size plans. No measurements to translate or confuse you. You see the entire violin in the plans. You read the how-to-do-it instructions in the book.

MINIATURE ENGINES

GASOLINE — STEAM

BUILD THEM YOURSELF—IN YOUR OWN SHOP WITH YOUR OWN TOOLS

Anyone with a 6" or 10" lathe and a drill press can make them.

Send 10c For Illustrated Catalog of Miniature Engine Castings and Drawings

OPTURA MODELS
P.O. BOX 536-D PARK RIDGE, ILL.

NEW POWER FOR OLD BATTERIES

Amazing "New Life" battery rejuvenator stops build up of destructive plate sulphates... keeps battery automatically charged. Use lights, heater, radio as much as you like even in zero weather. Get faster starting! Greater Power!

RECHARGING IS UNNECESSARY! Extend useful life of new or mechanically sound old batteries for many months. Easy to use... only one treatment needed. Money back guarantee. Rush only \$1.00 per box.

MAIL COUPON TODAY!

JSM PRODUCTS CO., DEPT. 10
1118 Castleton, Cleveland 21, Ohio

Please rush me packages of "New Life" @ \$1.00 each. I enclose \$....., payment in full.

MY NAME

ADDRESS

CITY..... STATE.....

Enjoy Modern Living • Make Your Home Worth More With This Popular Mechanics Book . . .



759 PICTURES

Above: How to lay a new roof over the old.

Right: New walls over the tired old walls. A few of the 83 modern kitchen ideas.

Below: Modern ceilings for old basements.

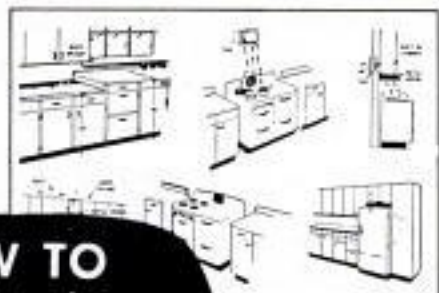

HOW TO Remodel Your Home

With Data on New Materials and Products Available to Home Owners

Here are hundreds of ways you can make a modern home out of an old house, make the house worth more and save money while doing it. If you own an old house or intend to buy one, get "How to Remodel Your Home" by E. R. Haan, formerly technical editor for Popular Mechanics. You can do the modernizing yourself or have it done for this vital book contains 547 methods and 759 illustrations covering complete modernization, adding rooms and living space, installing new kitchens and baths, adding closets, wardrobes, rumpus rooms. Complete face-lifting jobs for the outside and morale building jobs for the inside. Learn the joys and conveniences of modern living with this vital book prepared especially for the home owner. Mail coupon for your copy today.

Money Back if You Want It.

Get the book now. Check it for information that will help you improve your home for appearance, convenience and value. If not fully pleased return the book in 7 days and Popular Mechanics will refund every penny you have paid.

Big Book.
Same Size as
This Magazine.



What to Do!
How to Do It!
How to Cut Costs
and Save

In this book — 17 big helpful sections. They are:

From old to new—
Your modern kitchen — Better bathrooms — Basement rumpus rooms — Curing wet basements — Attic space and dormers—
Adding rooms to the outside—Porches and breezeways — Utilizing idle space—New look for outside walls — Modern interior walls—Heat-loss and humidity controls — Roof framing and covering—Windows that modernize — Entrances and doors — Variety in floors — Wiring, plumbing heating. In all—547 money-saving articles you can use.

Use Coupon to Get Remodeling Book

POPULAR MECHANICS PRESS, 200 E. Ontario St., Chicago 11

Send at once "How to Remodel Your Home," postpaid for \$2.95.

I understand I may return the book in 7 days for full refund.

Remittance for \$2.95 enclosed. Send book postpaid.

Send COD. I will pay postman.

Name _____

Address _____

City _____ State _____

free!

308 VALUE-PACKED PAGES



1955 ALLIED TV & RADIO CATALOG

SAVE ON EVERYTHING IN ELECTRONICS

World's Largest Stocks... Everything for Experimenters, Builders, Amateurs, Servicemen, Engineers & High Fidelity Specialists.

Send for ALLIED's big 308-page value-packed buying guide to *everything* in TV, Radio and Electronics! Largest selections of custom TV chassis, antennas and accessories; FM and AM tuners; High Fidelity systems and components; Amateur supplies; recorders and phono equipment; test instruments; builders' kits; industrial electronic supplies—plus the world's largest stocks of electronic parts, tubes, tools and books. Get *everything*—get more for your money—send today for your FREE 1955 ALLIED Electronic Supply Catalog.



ultra-modern facilities

TO SERVE YOU BEST!

Send for
FREE
Catalog

ALLIED RADIO

ALLIED RADIO CORP., Dept. 5-K-4
100 N. Western Ave., Chicago 80, Ill.

Rush FREE 1955 ALLIED 308-Page Catalog

Name _____

Address _____

City _____ Zone _____ State _____

America's LOWEST PRICED Liquid Duplicator

Print as many as 5 COLORS at once — anything you can write, type or draw with a Master Portable Liquid Duplicator. It's clean and easy to use — no stencils or inks required.

The Master Portable Liquid Duplicator gives you the same high quality prints as the most expensive rotary machines. Though not as fast, you get bright clear copies everytime.

For your letters, bulletins, charts, maps, etc. — One job may pay the cost of this machine.

Order yours today from your office supply dealer. If he can't supply you, we'll ship direct on a Money Back Guarantee.



MASTER Portable Liquid Duplicator

Letter Size —
\$32.50
including metal
carrying case
and supplies
Legal Size —
\$39.50
complete

MASTER ADDRESSER COMPANY

6500-11 West Lake Street, Minneapolis 11, Minnesota

15 x 65 \$59.50

The wanted binocular. Tremendous power, brilliant illumination, wide field of view, streamlined design plus lighter, stronger metals make this 15 power glass easier to hold and use than many glasses half its power! Water-dust resistant, 8 1/2" x 2 1/2" — 51 oz. Objective lens ALMOST 3" across! Interior sides of VITAL prisms and front and rear Achromatics have been COATED for crisper, sharpest images—made by skilled optical craftsmen in Japan. 30 DAY NO RISK TRIAL. Return for refund if dissatisfied. Cash orders prepaid. C.O.D.'s require \$2.00 deposit—Add Lower 10% Federal tax. Genuine leather case, straps included. UNITED BINOCULAR CO., 9043 S. Western, Dept. ARF-8308, Chicago 20. DEALERS WANTED.



GIANT LENSE
ALMOST 3"
ACROSS!

SAY YOU SAW IT IN POPULAR MECHANICS

DYNA-MITE* POCKET RADIO

U. S. TRADEMARK

1000 Mile Reception! Not a toy. A real electron tube personal radio covers broadcast band 540 to 1600 KC. Reception clear as a bell. All parts, hearing aid batteries, fit in case. For home, office or anywhere. GUARANTEED PRECISION BUILT PARTS. Kit includes photodiagramme for easy assembling. Batteries \$1.15 per set. Regular \$2.50 ALNICO MAGNET EARPHONE only \$1.45, or 1900 ohm Hearing Aid Earset (\$10.00 value) only \$4.95. C.O.D. orders accepted with \$1.00 deposit.



\$5.99
postpaid

Factory assembled (set only) \$8.95

PRECISION ELECTRONICS, Dept. W, Placerville, Calif.

BE YOUR OWN BOSS

Make Hundreds of \$ Spare or Full Time Work

You can make simply and cheaply

NO EXPERIENCE NEEDED

Here is the ideal business with no previous experience or large investment required and no high-priced equipment to buy. A business that will return dollars for the pennies you invest.

YOU CAN CAST ANYTHING

With *Flexible Mold Making and Ornamental Casting*, an amazing fact-packed book, you learn how you can cast practically any article in concrete, plaster, imitation marble or any other casting material using a marvelous new process. You can make ash trays, novelties, garden and lawn ornaments and hundreds of other highly profitable items that cost you but a few cents and sell for as much as \$5.00 and more. Why you can even make true-to-life full-sized busts of your neighbors and friends.

NO EXPENSIVE MOLDS TO BUY

Why buy high-priced molds from others? Learn how you can make your own molds quickly, easily and inexpensively with materials that can be used over and over. You get copyrighted formulas, complete instructions and detailed how-to-do-it photographs as well as complete sources of supply for the few inexpensive materials you need. This is the only book printed in America today that contains instructions for making profitable papier-mache casts.

MONEY BACK GUARANTEE

Start on your road to extra income and independence today. Send only \$3.00 for your copy of *Flexible Mold Making and Ornamental Casting*. Complete satisfaction guaranteed or your money refunded within seven days.

POPULAR MECHANICS PRESS, Dept. 46

200 E. ONTARIO ST., CHICAGO 11, ILL.



200 ONE-EVENING PROJECTS

Start and Finish Any One of These Projects in One Evening!

The editors of Popular Mechanics have assembled 200 projects, any one of which you can start and complete in a single evening. In a few hours' time, using only simple hand tools, you can build a coffee table, magazine rack, end table or scores of other useful projects. There are projects for the entire family. Best of all, any one may be built in just a few hours. No special skills are needed. Even if you have never built anything before, you can build the 200 projects in this big new book!

Step-by-Step Instructions, Show-How Photos, Drawings

First you read how to do it in famous Popular Mechanics step-by-step instructions and then actual photos, drawings and diagrams show you how it is done.

Each Project Costs Just 1c

Just imagine! Each project costs you only 1c. Where else today can you get so much for so little? Fill out and mail the coupon now. Full money-back guarantee, of course.



POPULAR MECHANICS PRESS, Dept. EP-1
200 E. Ontario St., Chicago 11, Ill.

Gentlemen:

Remittance for \$2.00 enclosed. Rush postpaid my copy of 200 ONE-EVENING PROJECTS. Unless it is entirely satisfactory I may return it in seven days for a full refund.

NAME _____

ADDRESS _____

CITY _____ ZONE _____ STATE _____

Send C.O.D. (U.S.A. only). Postage extra.

SAVE GAS PAY NOTHING

ON OUR TEN DAY FREE TRIAL

Send no money, pay postman calling for the new miracle gas savers. Gas costs about 30¢ a gallon. You can save up to 25% or 2¢ per gallon on your gas bill. Thousands of satisfied customers have sent their requests for the miracle gas savers. You are under no obligation.

If you are completely satisfied within ten days send us \$1.50 per gas saving nozzle.

(8 cylinder cars take two)

If you are not completely satisfied, return the merchandise.

FREE with every request.

Mehren's 50¢ Catalog

Book. Safety and economy items

and tips for better driving. Mail

your request today. Specify

year, make, and model of your

car when requesting free trial.

MEHREN INDUSTRIES

8546 W. PICO, DEPT. PM-10

LOS ANGELES 35, CALIF.

Learn Quickly, Easily With This MULTI-CIRCUIT RADIO LAB KIT



Designed for those just starting in radio and electronics. With this kit build 6 useful and educational circuits. Simple circuits, can be built by anyone. Low voltages — safe. Complete with pictorial diagrams and instructions. No previous knowledge necessary. With 48N7 Radio tube, selenium rect., power transformer, all parts, nuts, board, and incl. less head-phone (also serves as mike), wire and solder. For 110-120 V., 50-60 cycles AC. Now only **\$8.95**

Headphones, single 1000 ohm. . . **\$1.10**

EDUCATIONAL ELECTRONICS
Dept. PM-10, 1771 W. Howard St.,
Room 214-A, Chicago, Ill.

POWER HACKSAW \$55.75

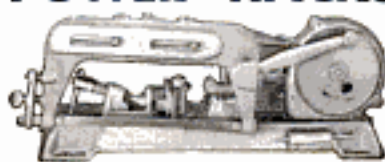

LESS MOTOR
F.O.B. Benton Harbor

• Rugged cast iron construction. Wt. 56 lbs., bronze bearings. Draw cut. Auto. return lift. Auto. shut-off. Vise swivels 45°. Cap. 4"x4".

Send for full details and name of nearest dealer.
EXCEL MACHINE TOOLS Dept. PM-104 BENTON HARBOR, MICHIGAN

Save Money on TV Purchase, Repair and Service

ALL ABOUT TELEVISION You can actually save \$50 to \$100 when you buy a TV set. You can save that much more every year on service with Popular Mechanics All ABOUT TELEVISION to guide you. Do 9 out of 10 service jobs yourself. Complete simplified instruction and 220 pictures show you how. No previous experience or knowledge of electronics required. Cloth bound edition only \$1.98 postpaid. Money back if not pleased.

POPULAR MECHANICS PRESS, Dept. PM11, 200 E. Ontario St., Chicago 11

START YOUR OWN BUSINESS OR ADD TO YOUR PRESENT ONE

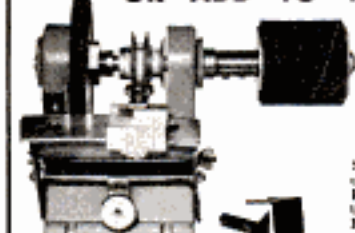

BRAND NEW ALL-IN-ONE SHARPENER
Precision Made Ball Bearings

Sharpens all makes and models of PINKING SHEARS, Scissors, Knives, etc. Does a precision job unmatched by other sharpeners. Easy to operate.

(Pulley and Stone Guards included) **ORDER TODAY \$69.50 F.O.B. Factory**
WILL PROVIDE STEADY, IMMEDIATE, YEAR ROUND INCOME. \$75-\$125 a week. No skill required. Complete instructions supplied. For use on trucks, in your shop or door to door; establish routes among dressmakers, barber shops, beauty salons, butchers, etc. BE FIRST in your town to have complete sharpening service. Write for pamphlet.
TURPIN-JONES CO., P.O. BOX 1109, PASADENA 1, CALIFORNIA

PUMP WATER FAST!

Save over 30% by buying direct from our factory to you. We pay all shipping except on deep and shallow well kits. Send cash, check, or M.O. Or sent C.O.D.

HEAVY DUTY BRONZE GEAR PUMPS

Self-priming to 20 ft. Pulls from 25' well with foot valve. Operates in either direction. Pressures up to 100 lbs. Threaded for pipe. Excellent shallow well pump, fire protection, booster pump, fountain pump.

Motor				Motor			
No.	Size	GPH	Price	No.	Size	GPH	Price
1-AX	1/8	100	\$12.50	7-AX	3/4	1200	\$24.75
2-AX	1/4	200	14.50	8-AX	1	1800	26.25
3-AX	3/8	400	17.00	11-AX	1 1/4	3600	85.00
4-AX	1/2	650	18.75	13-AX	1 1/2	5400	101.00
				20-AX	2	10,800	220.00

Channel steel base for any pump above—\$7.00 extra

FAMOUS MOOREWATER PUMPS

Drains Wash Tubs, Cellars, Closets. Famous 27 pumps 2800 gph. 420 gph. at 75' high or 1600 gph. from 25' well. Sturdy rustproof alloy metal. Six blade impeller. 3/4" inlet, 1/2" outlet. Standard pipe threaded. Uses any 1/2 to 1 1/2 H.P. Motor. **\$8.95**
Will not leak or clog.

Irrigate, Fill Tanks, Draw Well Water. Heavy duty 28 pumps 7000 gph.—1000 gph., 75' high 3000 gph. from 25' well. Rustproof alloy, 8 blade impeller. 1" inlet, 1" outlet. Standard pipe threaded. Will not leak or clog. **\$11.95**

Build Lakes, Rivers, Waterfalls with miniature water pump. Only 4 3/4" high — 3 1/4" wide. Threaded for pipe or uses 3/8" rubber tubing. Sturdy rustproof alloy metal—mounted on rubber. 110 A.C. — 60 cycle. 1/250 H.P. 50 gph. Complete. **\$9.95**
—ready to work.

BRONZE RUBBER IMPELLER PUMPS

Self-priming to 20 ft. Pulls from 20' well with foot valve. Operates in either direction. 30 lb. pressure. Ideal for: Boat pumps, lawn sprinkler, water transfer, booster pump and water fountain. Has replaceable impeller. RA-100 GPH **\$15.00**, RB-600 GPH **\$18.50**, RC-1200 GPH **\$25.00**. Channel steel base for above pumps —\$3.00 extra.

FREE Send in sketch of your pump problem. Our engineer will send recommendations. . . Free of Charge.

MOUNTED UNIT

RA Rubber Impeller Shallow Well Pump gives 160 GPH at 30 PSI. Self-priming to 20'. Complete with new 1/2 H.P. Westinghouse Motor. Mounted on channel steel base. **\$39 PP.**

SEND FOR FREE CATALOG



Complete SHALLOW WELL KIT (For Lifts to 25' convertible to deep well) Gives 500 GPH at 40 PSI Discharge! Everything you need in kit form for complete shallow well water system. Includes: Pump-motor unit completely assembled, pressure switch, pressure gauge, pump to tank fittings and jet charger. Motor: 1/2 H.P. 115 V electric. Tank: 12 gal. non-corrode galvanized. Pipe size: 1" wide; discharge 3/4" max. working pressure 47 lbs. Shipping weight! **\$111** for 105 lbs. . . **\$111** plant

Complete DEEP WELL PACKAGE SYSTEM. For lift to 60' convertible to shallow well. Goes down deep to bring water—fast! Pump-motor assembled mounted to 12 gallon pressure tank. Kit includes pressure switch, pressure gauge, pump to tank fittings and jet charger. Motor: 1/2 H.P. — 115 V electric. . . **\$117.50** plant

Iron Clad Guarantee
All Moorewater pumps are sold under an ironclad guarantee. Pumps & motors are guaranteed both by original manufacturer and by us. Send check, M.O., or sent C.O.D.

MOORE
MANUFACTURING CO.
SWEDISBORO J.
NEW JERSEY

What to Make with CONCRETE

Even little concrete jobs cost big money — mostly for labor. Get Popular Mechanics WHAT TO MAKE WITH CONCRETE and save all the labor cost while making your home or farm ship-shape. Book shows all—tells all — how to make the right mixture, plan, apply and gives 50 professional short cuts. Hundreds of pictures. Only \$2.00 postpaid. Order today. Money back if not pleased.
POPULAR MECHANICS PRESS, Dept. PM9, 200 E. Ontario St., Chicago 11

DO-IT-YOURSELF TABLE KIT

Make any one of these 5 beautiful tables from one complete kit.
COCKTAIL • LAMP • STEP • COFFEE • SWIVEL-TO TV
Kit contains solid Mahogany 3/4-in. thick plywood top (18x36-in.), 4 squares for legs (2x2x24-in.) plus screws, glue, etc., also complete Instruction Booklet for assembly and finishing. Also available in genuine Walnut, Maple or Oak.
All materials guaranteed highest quality, ready to be toolled and assembled.
Send check or M.O. for **\$9.95** (Shipped Exp. Collect)
HARDWOOD DESIGN CORP.
1245 W. Devon Ave., Chicago 40, Ill.

the TV world is yours with

WARD TV ANTENNAS



DYMON-VANE



FRINGEMASTER



WARRIOR



TROMBONE

WARD ANTENNA RAMA

Only Ward presents such an outstanding array of precision-engineered TV antennas. Among them is "Dymon-Vane", the first to combine distinguished beauty with superb reception. Consult your local TV dealer about WARD antennas or mail coupon below.

WARD PRODUCTS CORP.
DIV. OF THE GABRIEL CO.

1148 Euclid Avenue, Cleveland 15, Ohio

WARD PRODUCTS CORP., DIV. THE GABRIEL CO.
Dept. PM1054, 1148 Euclid Avenue, Cleveland 15, Ohio
Send me free additional information on
Ward's complete line of TV antennas.

Name _____
Address _____
City _____ State _____



Give the gift of
carefree
motoring!

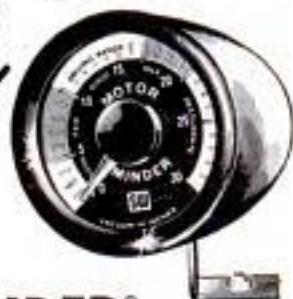

STEWART-WARNER

MOTOR MINDER®

Checks engine performance on-the-road —
Shows how to save gas, avoid repair bills!

If he drives, here's the perfect Christmas gift! The Stewart-Warner Deluxe Custom Model Motor Minder checks engine performance—as he drives! See how to s-t-r-e-t-c-h gas mileage. This combination engine analyzer and driving gauge shows performance of plugs, valves, carburetor, manifold, piston rings, etc. Warns of trouble. Illuminated Dial. Simple installation.

only \$10⁹⁵

It's the gift
that pays for itself!

Get it at your dealer's. If he cannot supply you, send us his name and address with your check or money order for \$10.95. Motor Minder will be sent prepaid!

STEWART-WARNER

Instrument Division, Dept. N-104
1840 Diversey Parkway, Chicago 14, Illinois

The Most Fascinating Book About the Automobile Ever Printed!

Popular
Mechanics

AUTO ALBUM

The Motor Car in Picture
and Story from
1769 to 1952



You'll Find...
the Answers... the Fascinating Stories...
in the AUTO ALBUM

Who built the first horseless carriage?

Who obtained the first U.S. patent on an automobile?

Where did the name "automobile" come from?

Are you familiar with the workings of the Stanley Steamer... the "electrics"... the famous Ford Model T?

Do you know when the first Indianapolis race was won... by whom... at what speed?

Do you know the story of Henry Ford, Barney Oldfield, Ransom Olds, Walter Chrysler, W. C. Durant and other automotive giants?

166 Illustrations Including
94 Old-Time Cars — 22 Auto
Ads of By-Gone Days!

Here is a book you can't help enjoying and wanting, whether or not you have, or ever will own an automobile. It is the fascinating, thrilling and informative story of the horseless carriage from the first gasoline-propelled buggy to a forecast of the atomic car of the future.

Popular Mechanics AUTO ALBUM by Throm and Crenshaw presents America's first cars and the pioneering men who made them; the scrambled start and the development of the fabulous auto industry; the story of automobile racing; the growth of the Nation's highways. It is a book that just had to be published.

To Read... to Enjoy...
to Remember!

More than one-half of the book is pictures, most of them action pictures, from photos of old-time cars in operation. Other pictures show race cars from 1911 to 1951; early auto advertising, picturing 32 cars priced from \$375 to \$6000; tri-cycle autos, wind wagons, auto cycles and other automotive oddities. A roll call of horseless carriages is included — the names of more than 2000 cars made in the United States.

Gift Book of the Year

Get the fascinating AUTO ALBUM for yourself today. Send it as a gift to friends and business associates. Order on coupon below. Money refunded if you are not entirely pleased.

Cloth
Binding



Use Coupon to Get AUTO ALBUM

POPULAR MECHANICS PRESS, 200 E. Ontario, Chicago 11

Send at once postpaid — copies of Popular Mechanics AUTO ALBUM at \$3.00 each. Remittance enclosed. Send COD. I will pay postman plus charges. I understand books are returnable in 7 days for full refund if I am not pleased.

Name _____

Address _____

City _____ Zone _____ State _____

ELECTRIC SANDER

Now at Remarkably
LOW PRICE!



Buy direct from factory and save! SANDRITE is the finest ORBITAL MOTION sander at any price. Fast — powerful — light weight! Sealed precision bearings — no greasing or oiling necessary. Cast from Hi-Strength Aluminum Alloy. Bodine 1/12 HP motor won't clog or stall. AC or DC. Hand Control Switch. Rough sanding or fine polishing—perfect ease in handling on wood, metal, plastics, wallboard, plaster. **SEND ON A MONEY BACK GUARANTEE.** Only sander using dual process of carborundum adhesive and clamps. 1/2" wool polishing pad \$2.00 extra. Order Today. Postpaid, only... **\$2975**

(C.O.D.'S ACCEPTED — SEND \$10.00 DEPOSIT)

SKOLD ENGINEERING CO.

DEPT. PM-10 1911 IRVING PARK CHICAGO, ILL.

AMAZING NEW KIT OF HARD TO GET BRASS FITTINGS! A \$17.50 Value for Only \$5.95



Keep it running with **MUELLER BRASS FITTINGS REPAIR KIT.**

Kit contains over a hundred brass fittings—fittings for maintenance of all types of Air Craft, Automobiles, Diesel, Gasoline, Oil and Steam Engines, Farm Equipment, Tractors, Trailers, Motor Boats, Pumps, Oil Burners, Refrigeration, Plumbing, Heating, etc. (These fittings can be used on all types of tubing.) Complete kit only \$5.95 prepaid. Mail check to—**MUELLER SALES, 5167 W. Montrose Ave., Chicago 41, Ill., Dept. PM-10.**

Protect Yourself With a **SPEEDY HAND STAMP**



Here's protection against loss of tools, garden equipment, bikes, skates, etc.—proves ownership of property. Stamp YOUR name permanently on wood, metal, leather, plastics, with a **SPEEDY HAND STAMP.** Can save you many dollars, grief or arguments. Highest quality. Comes with 3/32 in. characters. You can have up to 10 letters or figures on a stamp. Print reading wanted when ordering.

Order yours today—ONLY **\$4.25**

QUALITY DIE COMPANY 3065 East 93rd St., Dept. PM-10, Chicago 17, Ill.

YES! SEND



directly
to my door
every month

I am enclosing

- \$3.50 for 1 year
 \$8.00 for 3 years

name _____

address _____

city _____ zone _____ state _____ C-104

Hand this order to your newsdealer or send it to

POPULAR MECHANICS
200 East Ontario St. Chicago 11, Ill.

Your Car's Water Pump needs Lubrication, too!



The heart of your car's cooling system is the pump that circulates the water. Completely enclosed, your pump never derives benefit from the lubrication applied regularly to other parts of the car, yet it operates continuously while the engine is running.

Permatex Water Pump Lubricant provides the internal lubrication that every water pump should have. It mixes perfectly with cooling system water and anti-freeze to thoroughly penetrate the moving parts of the pump. It prolongs pump life—prevents wear and squeaking. Contains Anti-Rust to keep the radiator water supply crystal clear. Prevents rust for entire season.

Install one can of Permatex Water Pump Lubricant now. Available at garages and service stations everywhere. The distinctive Permatex label has been a guarantee of quality for over 45 years. Permatex Company, Inc., Brooklyn 35, N. Y.

PERMATEX

Water Pump Lubricant and Radiator Anti-Rust

Over Fifty Chemical Products for Better Automotive Maintenance

Amazing New **FASTER, EASIER, BETTER WAY TO PAINT**

COMPLETE SPRAYING KIT!

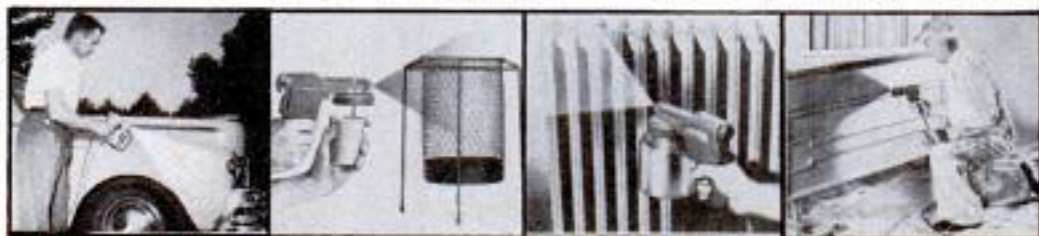

NOW ANYONE CAN GET PROFESSIONAL SPRAYING RESULTS WITH THIS ALL-METAL SPRAYER!

No More Brushmarks! No Tiresome Brushing! Simple, Easy To Use! Just Pull the Trigger and you're spraying like an expert! Now, at last! A complete, ready-to-use spraying kit that anyone can afford! No compressors, motors or extras to buy!

Do Your Own Painting and Decorating with the All-Purpose, Self-Contained Super Jet Spraying Kit! Now you can apply those beautiful, unusual finishes, that you've been reading about on your favorite furniture. You no longer have to leave spraying to skilled, high-priced professionals. Super Jet is so simple to operate that any inexperienced person — even a child can get professional results the very first time. Yes, now spraying is as easy as pointing your finger or pushing a button. Once you've used Super Jet, you'll find more and more uses for it every day!

**NO CLOGGING
NO SPITTING
SMOOTH
TROUBLE-FREE**

**JUST PLUG IN AND SPRAY —
LACQUER • VARNISH • WATER
OR OIL BASE PAINTS • SHELLAC
ENAMEL • INSECTICIDE • WATER
SOLUBLE PLANT FOODS • MOTH-
KILLERS • WATER AND OIL!**



Simply plug Super Jet into any 110 Volt A.C. electrical outlet and you can spray anything your heart desires—anything inside or outside the home — whether it's walls, floors, screens, windows, or trim. You'll find you can spray-paint jobs 7 times faster than old-fashioned brushing methods... and it's less tiresome, too, because Super Jet is clogproof and perfectly balanced for trouble-free operation.

This complete versatile spraying kit also permits spraying directly from open containers. There is no "pressure seal" required, because Super Jet operates on an amazing new principle that does not use air pressure for its action. With this new kit you can spray any amount of liquid — whether it's a thimbleful or a barrelful, directly from the source without stopping to refill the jar!

A COMPLETE SPRAY KIT!

\$29.95 • Only \$1.00 A Week

- NEW SUPER JET SPRAY GUN
- HI-TURBULENCE GEM NOZZLE
- POLISHED ALUMINUM JAR
- AUTOMATIC PAINT STRAINER
- 15 FT. DISTANCE TUBING
- 23 FT. NEOPRENE CORD SET
- SPARE PARTS
- WALL CHART & INSTRUCTIONS
- STEEL CARRYING CASE

PLUS Your Name in 23 KARAT GOLD written on Super Jet Carrying Case

4 BIG REASONS WHY SUPER JET IS SO EASY TO USE!



No Nozzle Adjustment!



1 Control Knob!



Automatic Strainer Prevents Clogging

All metal screen strains out all particles in the spraying material.



MAIL COUPON TODAY FOR 10 DAY FREE TRIAL

POWER PRODUCTS, INC. Super Jet Division 10A
175 E. 87 St., New York 28, N. Y.
Please send amazing new SUPER JET SPRAY KIT. I must be completely satisfied or I may return within 10 days for full refund. I am using payment plan checked below.

Enclosed is \$29.95 in FULL PAYMENT including postage. Be sure to send my FREE GIFT plus EXTRA BONUS for full payment.

OPEN CHARGE ACCOUNT. Enclosed is \$3.00. I will pay balance of \$26.95 plus postage and small service charge at \$1.00 a week. Send FREE GIFT.

SEND C.O.D. Enclosed is \$3.00. I will pay postman \$26.95 plus postage and C.O.D. charges. Send FREE GIFT.

YOUR NAME will be written in 23 Karat Gold on your kit. Please Print Carefully.

NAME _____
ADDRESS _____
CITY _____ ZONE _____ STATE _____

FULLY GUARANTEED! 10 Day Free Trial

Just \$1.00 a Week!

Get the amazing new Super Jet Spray Kit on a simplified budget plan for only \$1.00 a week. Send \$3.00 with this coupon and start your painting immediately. Power Products opens up a charge account for you to pay for your Super Jet Kit as you use it! Same 10 DAY FREE TRIAL and MONEY BACK GUARANTEE. MAIL COUPON NOW!

FREE! Mail Coupon TODAY and get Free 5-piece pocket Screw Driver Set.

EXTRA BONUS!

Send \$29.95 in full payment of your SUPER JET SPRAY KIT and receive as extra bonus tool kit pictured!



SUPER JET Cleans Itself



Simply spray solvent through the gun for 20 seconds and Super Jet is clean and ready for another job... nothing to take apart!

POWER PRODUCTS, INC., 175 E. 87th St., N. Y. C.

Copyrighted material

WELD IT YOURSELF! IN A JIFFY!

**Weld, Cut, Braze, Solder
IRON, STEEL, BRONZE, BRASS,
ALUMINUM & OTHER METALS**

Tool and Equipment breakdowns are always annoying and costly. Don't let them bother you. Get a Dynamic Arc Welder. You can do expert work on your very first job. Welders operate from any properly wired 110 V. AC line. Also make your own wrought iron furniture, railings, fences & knick-knacks. Repair fenders, & bodies, etc. with the handiest "tool" in your workshop. A Dynamic Welder will pay for its low cost of \$38.50 F.O.B. in both time and money.

DYNAMIC INDUSTRIAL type transformer Arc Welder 75 amp. output for Industrial or Workshop use.

**DYNAMIC
WELDER CO.**

Dept. D2-K, 1808 S. Federal
Chicago 16, Ill.

**EASY
PAY PLAN**

Low down payment. Pay as you weld. Sold on money-back guarantee. Send for details. Complete outfit only

\$38.50

f.o.b. factory



Free Details and "How to Weld"

**DOUBLE THE LIFE of your
CONVERTIBLE TOP**



Tough, clear vinyl plastic cover protects top from winter ice, summer sun, dust, salt air, harmful chemicals. "Topper" keeps you snug and water-tight. Pays for itself in longer top life. Quick and easy to install, fits perfectly any '42 to '54 model. Won't crack, peel, chip, or discolor. Reinforced at stress points, seams electronically welded. \$17.95, postpaid with check or money order. Postage extra on C.O.D. orders. Order today for self or gift. Specify make, year, and model. Satisfaction guaranteed or money back.

POSTPAID

\$17.95

MAMMOTH SALES CO., P.O. Box 52, Dept. B, Cincinnati 7, O.

**HARDWOOD LEGS
FOR "YOU-MAKE-IT" FURNITURE**

Solve problem of leg strength!

Laminated to shape—not bent. Take any finish. Easy to make useful, beautiful modern furniture with simple, ordinary tools. 4 sizes for you cut to suit: 1"x16", \$3.36; 2"x16", \$4.96; 2"x30", \$7.32; 2"x11", \$7.88. Send for set of 4 legs today—satisfaction guaranteed. Or get catalog of complete kits of furniture. Prices F.O.B. Send one-half cash or money order—balance C.O.D.

ECONOWAY, INC., Dept. M-1, Box 410, Niles, Michigan



DRIVE 500,000 MILES

**Without Need Of A Major Overhaul
ENGINEERS HAVE PROVEN THIS POSSIBLE.** They have shown that the combustion process produces more than a gallon of water in vapor or steam for every gallon of fuel burned. Some of these vapors enter crank case causing rust, varnish, acids and sludge.

INSTALL POWER VENTILATION—

**GET UP TO 2 or 3 MORE MILES PER GALLON—
CUT ENGINE WEAR UP TO 40%—**

Increase the overall operating efficiency of your car with amazing Moto-Vent. Positive Power Ventilation removes water vapors, sulphur and other corrosive materials that enter crank case. Not a "gimmick" or "gadget" but a precision engineered instrument designed to give better engine performance, up to 2 or 3 more miles per gallon and cut engine wear up to 40%. Oil and water vapors are fed back into the combustion chambers where they give you water injection and overhead lubrication. No extra oils or additives needed.

EASY TO INSTALL—DO IT YOURSELF. Fits all cars, trucks, tractors—old or new. Install Moto-Vent between oil breather and intake manifold in less than half hour. Will soon pay for itself.

FREE 30 DAY TRIAL OFFER. Moto-Vent complete with all fittings and easy to follow installation chart only \$4.95 postpaid, or, C.O.D. plus charges. Try for 30 days. If you are not completely satisfied, return for full refund. Send order or write for further FREE particulars, today!

PRECISION PRODUCTS CO.,

Dept. 25

Harvard, Ill.

**Why walk?
Why drive?**

GET TO THE JOB ON A

**Harley-Davidson
165**



WHY walk when you can ride? And why go through the agony of driving a car . . . when a 165 gets you there faster? It's the world's most practical transportation . . . safe, easy-to-ride and so economical, too. Lets you sleep later in the morning and gets you home earlier at night. Takes the irritating "jam" out of traffic . . . and there's *always* room for the 165 in any parking lot.

See the 165 at your dealer's now. Easy-pay plan. Send for *FREE* illustrated literature. Write: Harley-Davidson Motor Company, Department P, Milwaukee 1, Wisconsin.

AVERAGES UP TO

80

*Miles
per
Gallon.*

SAFE AND ECONOMICAL FOR SCHOOL AND PLAY

Get Prize-Winning Pictures and Enlargements

WITH THIS BRAND NEW GRAPHIC-GRAFLARGER

TAKE 'EM, MAKE 'EM OUTFIT!



ONLY
\$199.50

Complete in
Home Storage
Case

Camera fans! Here's an outfit that will enable you to take and make the best pictures you ever had! Think of it . . . you get a real press-type Century Graphic camera and a true precision enlarger for little more than you'd pay for the camera alone!

Your Century Graphic with the famous Grafmatic Sheet Film Holder, has the amazing versatility to conquer almost any photographic problem. The Graflarger, with its cold light illumination, sturdy, precision stand and handsome baseboard, is just what you need to make superb enlargements (up to 11 x 14) from your negatives. Here's a combination—at a price—that can't be beat! See your dealer today!

GET ALL THIS
FOR AS LOW AS \$19.95 DOWN

1. CENTURY GRAPHIC 23 with 103 mm., Graftar f/4.5 coated lens in Century synchronized shutter.
2. GRAFMATIC SHEET FILM HOLDER
3. GRAFLARGER COLD LIGHT BACK converts Century Graphic to a precision enlarger.
4. GRAFLARGER STAND holds combination rigidly, yet is easily adjusted.
5. Rigid, moisture-proofed, 18" x 30" baseboard.

GRAFLEX®

Prize-Winning Camera

Graflex, Inc., Rochester 8, N. Y.



FOR FULL INFORMATION

MAIL THIS
COUPON

GRAFLEX, INC., Dept. PM-19, Rochester 8, N. Y.

Please send me full information on your new "take 'em and make 'em" outfit.

NAME _____

ADDRESS _____

CITY _____ ZONE _____ STATE _____

DO IT
YOURSELF

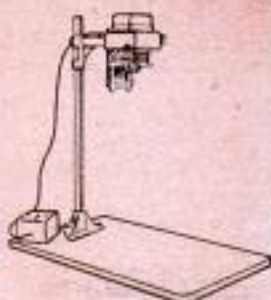

Used vertically, your Century Graphic-Graflarger gives enlargements up to 11" x 14".

HAVE MORE FUN

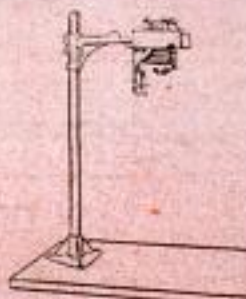

The Graflarger makes an excellent copying stand for the Century Graphic. Long bellows extension permits 1:1 copying.

SAVE MONEY!

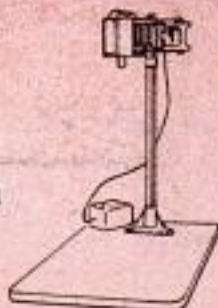

Used horizontally, your Century Graphic-Graflarger may be used for making big enlargements or murals.



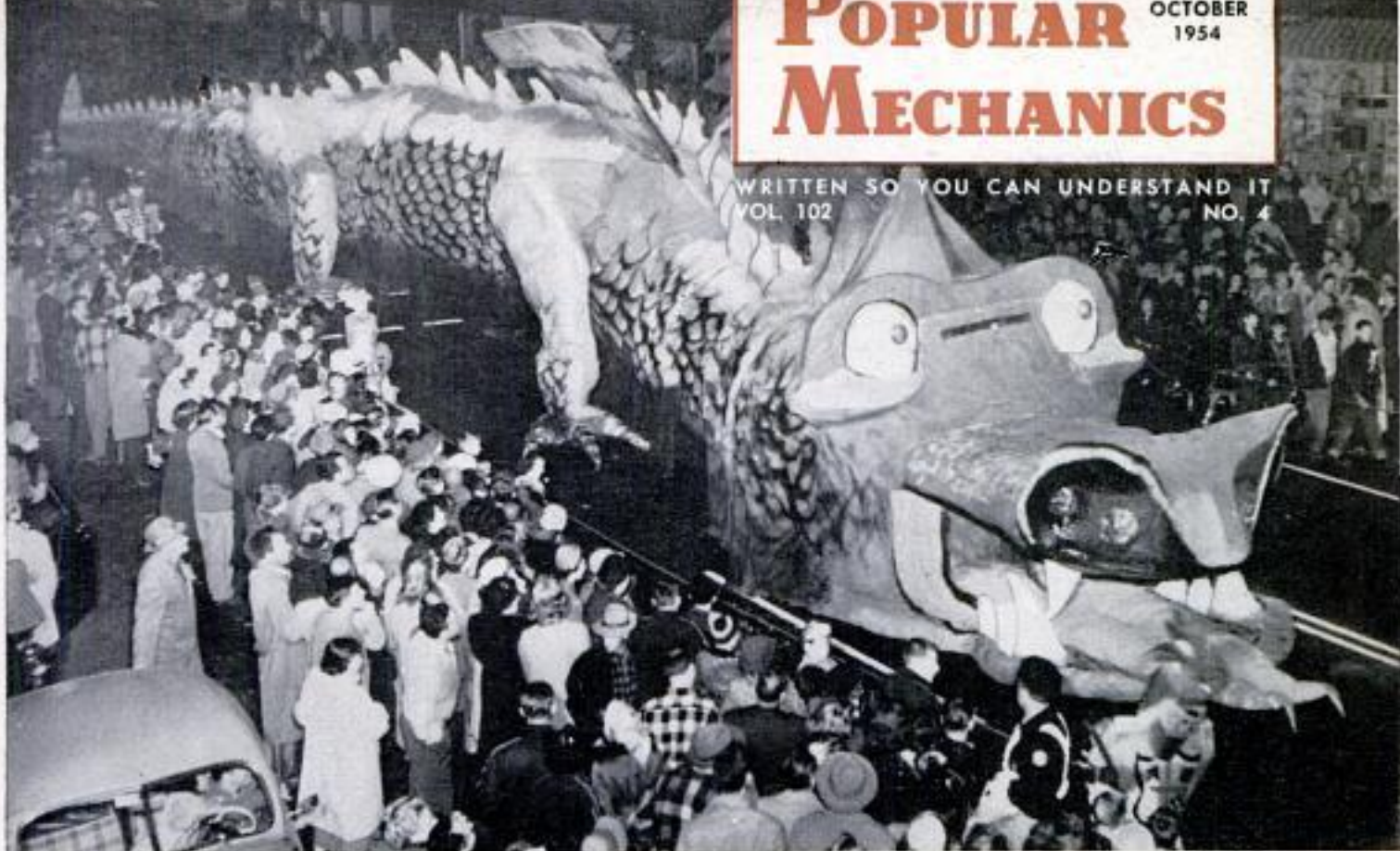

Pitt the Dragon, 165 feet long, slinks down the street, eyes rolling, tongue flicking, feet squishing down

MONSTERS ON PARADE

By Clifford B. Hicks

ONCE UPON A TIME long, long after the last knight in shining armor killed the last dragon, the children who dwelt in the town of Pittsfield in a place called Massachusetts learned that a monster was loose roundabout. Two men had come across the footprint of a strange, huge creature in a near-by swamp.

The townsfolk bolted the doors of their homes that night and the children covered their heads in their beds, wondering whether it would be safe to roam the dark streets on Halloween which, as it happened, was just a few days away.

But on the witching night the brave menfolk led their families out into the streets for the Halloween parade, just as though the monster weren't lurking near by. And the children clapped their hands as the parade passed by, though they kept glancing over their shoulders.

Then suddenly the monstrous monster appeared on the street, slinking along at the end of the parade. It was a dragon to end all dragons. Sixteen feet high it was, with scaly fins running down its back, a

tongue 13 feet long darting out of its mouth and bloody eyes 18 inches in diameter rolling at the crowd. Dragons, of course, have wings, and this beast had 24-foot wings that flapped above its back. As each huge

Dragon was built in sections, assembled at the last minute

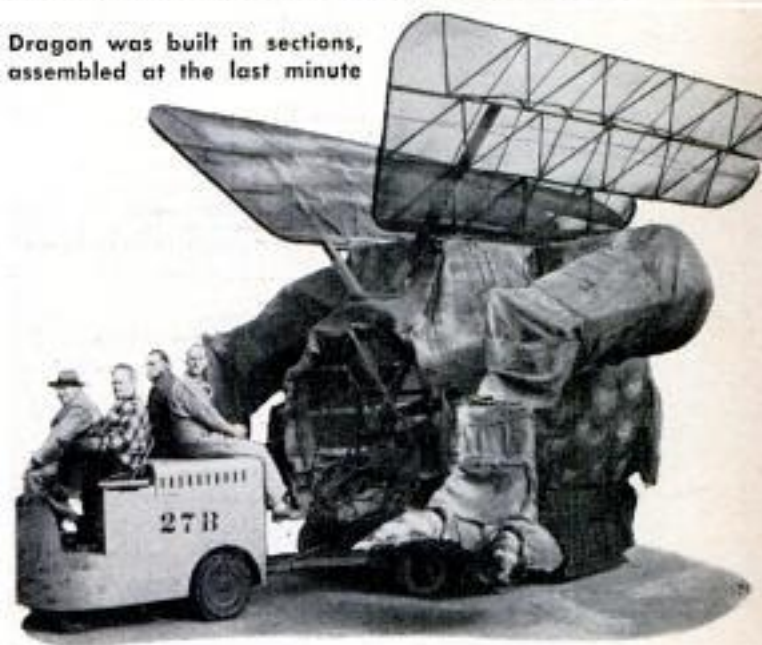



Hazel the Witch, 23 feet high to the tip of her hat, stands ready for the parade with her devils and bats

foot came down upon the pavement the claws squished out. An endless beast it seemed, measuring 165 feet from its huge flared nostrils to the weaving tip of its tail—more than half a block of dragon slithering through the town. Yet it wasn't such a fearful beast after all for, if you looked closely, you somehow got the feeling that it was a friendly sort of a creature that wouldn't harm the smallest child.

Skilled metalworkers built Hazel's framework and molded her huge skull while electricians installed loudspeakers, lights, and women helped with costume

The monster crawled over to the city park where the excited kids gathered roundabout to spend the evening. And, for the first time in many years, there wasn't a single bit of damage done in all of Pittsfield that entire Halloween!

What the townspeople couldn't see were the nine men inside the dragon's stomach. They rode an electric fork truck and nine trailers, and operated all the intricate mechanisms that made the dragon walk, wag its tail, open its mouth, roar, flicker its tongue and shoot smoke out its nostrils in a realistic manner.

Pitt the Dragon was very likely the longest parade float ever to roll down a crowd-lined street. Everyone who saw him two years ago was convinced that he was the most spectacular float that ever could be built. But last year, when the people of Pittsfield turned out for their Halloween parade, they saw two floats that were equally sensational—Hazel the Witch and the space ship.

All three floats were built by rank amateurs in the float-making business—the workers of the big General Electric plant in Pittsfield. Ordinarily these welders, electricians, draftsmen, managers and sweepers turn out big transformers and other electrical gear. But once a year they pool their talents to build out-of-this-world creations for the kids of their home town. They have become so adept at it that last year 65,000 people turned out to watch the parade in a city that has a total population of 54,000!

The story of Pitt the Dragon, Hazel the Witch and the space ship goes back about a month before Pitt first "walked" the earth. A few of the workers at the General

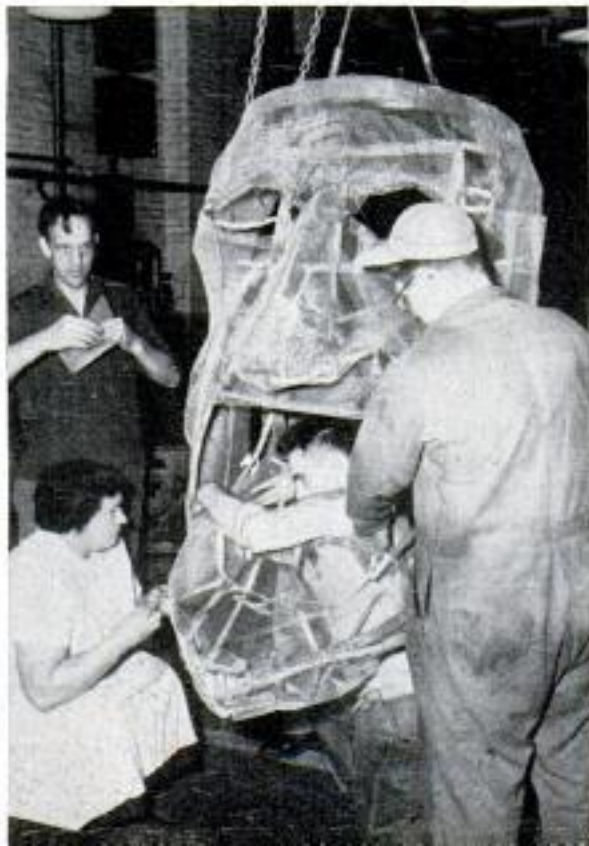
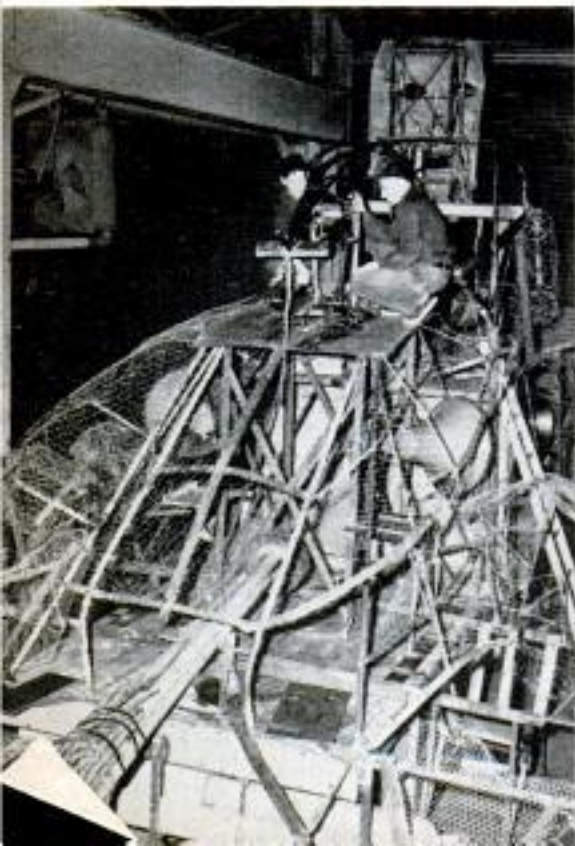

Electric plant conceived the idea of building a float—a small one—for the Halloween parade. Forming a committee, they asked management's permission to use the facilities of the plant in their spare time. Not only could they use the plant itself, came the answer, but the company would provide all the necessary materials, either from the scrap pile or from other sources. To the company it looked like good community relations.

What, then, would they build? A committee of 10 workers, headed by Joe Pavin, finally came up with the idea to build a smoke-spouting dragon. It was a little one, to be sure, but still a dragon.

Pledge cards were circulated through the plant to find out how many employees would be willing to give a few hours of their spare time to the project. Literally thousands of man-hours of skilled labor were pledged.

This looked good to Joe Pavin and his associates—so good that they quickly revised their plans by the simple expedient of multiplying everything by five. The planned 30-foot dragon became a 150-foot job, and eventually stretched its body out to 165 feet. Designers and draftsmen turned out drawings fast enough to keep the labor



Bats supported on welded steel chains piloted Hazel along the parade route while her big arms flapped

Five-foot cat on witch's back was covered with real sealskin. Intricate mechanism made him leap to his feet, arch his back and bare his teeth





Space ship zooms down the street, jet roaring, lights flashing, guns firing popcorn balls over the crowd

force busy. Welders built the framework. Electricians laid out the elaborate lighting system. The 1000-odd workers were organized into task forces, with each group responsible for a particular segment of the giant body. Executives found themselves working under sweepers, and sweepers

found themselves reading blueprints with an insight they never knew they had.

These mechanical experts weren't satisfied just to build a huge float. The eyes had to turn in unison, the jaws had to gobble, the nostrils had to shoot out smoke (carbon dioxide) and even the mythical wings had to flap.

Strategists conceived the idea of planting a huge footprint in a near-by swamp and knocking down an ugly trail with a bulldozer. Within two days the local newspaper received a letter from the curator of a museum in Connecticut asking for all

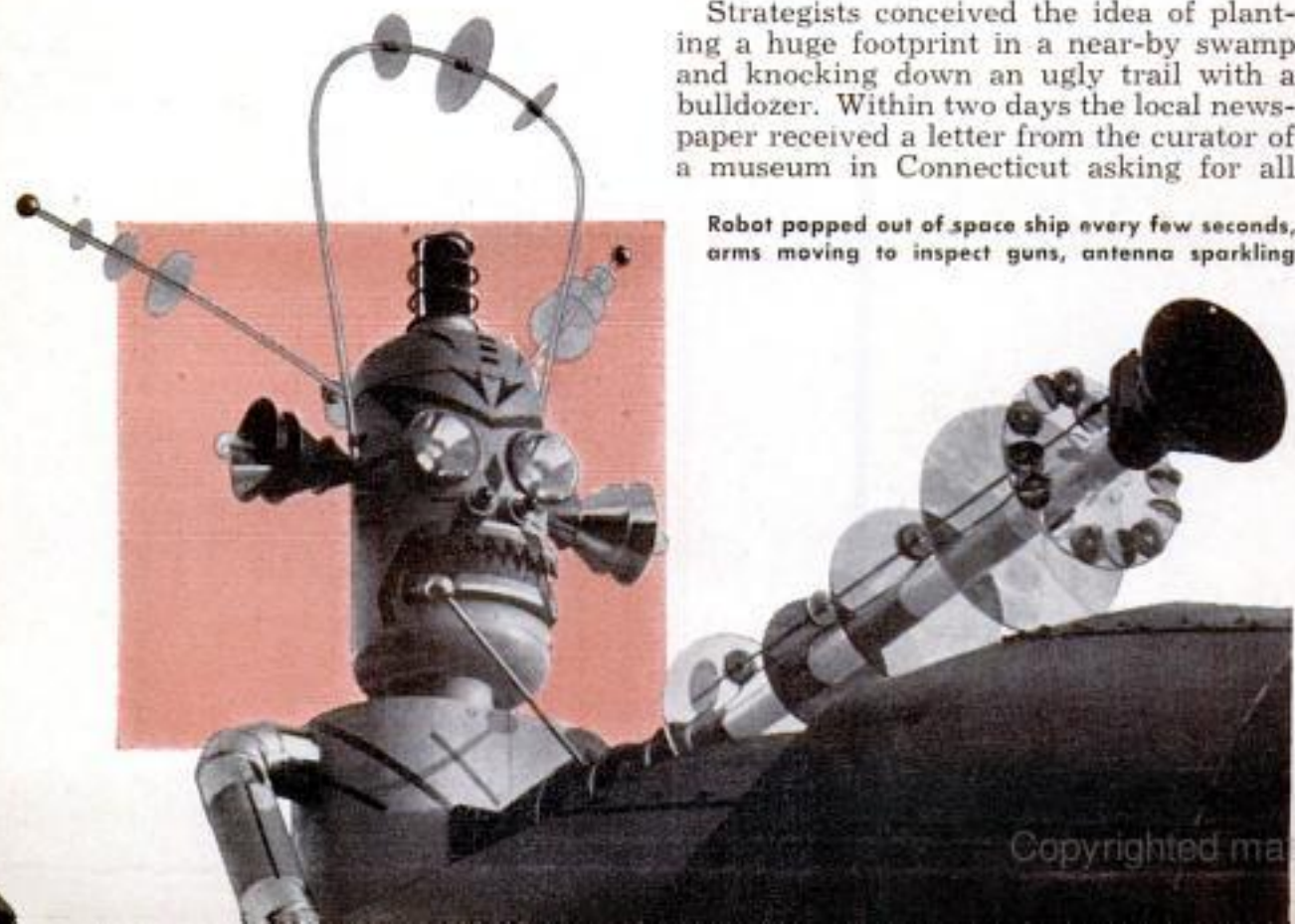

Robot popped out of space ship every few seconds, arms moving to inspect guns, antenna sparking



Workers who built the showboat donned elaborate costumes, formed a singing group and got into the act

possible information on the monster that was roaming the countryside!

In barely 3½ weeks came Halloween, and at two o'clock that afternoon Pitt's parts were rolled out of the shop. The parade marshal, who stopped by for a look, shook his head and said the thing never could be put together. But at 8:00 o'clock that night Pitt slunk down the street to join the parade. As he left the plant, a human being, dwarfed by the monster, chased after him with a spray gun to give his tail a final touch-up.

The night the dragon walked the streets of Pittsfield will never be forgotten by anyone who saw it. Neither will his caterwauling voice, which was simply a 78-r.p.m. recording of Johnny Ray's "Cry" played at 33-1/3 r.p.m.

Pitt was such a huge success that enthusiasm ran high last year as Halloween approached. Workers of the various departments finally teamed up to build separate floats.

Hazel the Witch was probably the ugliest and heaviest creature ever built. She weighed a walloping seven tons in her huge stocking feet, made of brilliant awning material. To the tip of her hat she measured 23 feet high, and had to be designed so her head would retract into her shoulders so she could pass under electric wires. She was 22 feet long, with a skeleton made of channel steel, pipe and angle

steel fastened to a five-ton electric truck.

Her skull, built of wire netting on a steel frame, was plastered with papier-maché carefully molded into the ugliest possible features, including a wart on her nose as big as your fist. Her jaw was counterbalanced so it could be moved up and down in time to her horrifying voice, broadcast over a public-address system located between her knees. Her eyes were two spotlights (one winked out at the last minute, giving her an even more evil look than her designers anticipated) and a green floodlight between her hands cast an eerie glow over her wrinkled face. As she moved down the street on her huge broom, a series of intricate levers flapped her arms.

Suspended in front of Hazel on welded steel chains were three huge bats. Their wings flapped and their red eyes blinked on and off. Their bodies were covered with real sealskin donated by a local furrier.

Last, and probably the crowning touch, was the black cat that rode on Hazel's back. A huge five-foot creature, the cat normally sat there purring in contentment. But suddenly he would turn into a snarling infuriated beast. Leaping up, he'd arch his back, open his mouth, lay back his ears, lift his four-foot tail and scream his displeasure. He was covered with real sealskin and skunk fur.

Inside Hazel were 12 men who operated

(Continued to page 366)



Amphibious Craft Combines Boat, Automobile and Airplane

Elements of an automobile, a boat and an airplane are all combined in a strange craft built by Eldon O. McKinney of Palm Springs, Calif. The amphibious vehicle is powered by an aircraft engine and propeller. Folded up for the highway, it is eight feet wide and 25 feet long. It is equipped with a steering wheel and four-wheel

brakes. At the launching site, pontoons are unfolded from the sides, making the craft 13 feet wide. It is driven right into the water. As soon as it is afloat, the wheels are retracted. In the water the craft is capable of 13 to 15 knots. McKinney uses a hand-operated winch to help the engine in launching or beaching the craft.



Hydraulic Wedge Topples Trees

Lumberjacks have a new tool—a hydraulic wedge that tips over trees. The portable machine replaces the sledge hammer and numerous steel wedges ordinarily used. It consists of a hydraulic pump, a power cylinder and a tapered wedge. The tree cutter inserts two blades, which sheathe the wedge, into the deep cut made by the saw. When he pumps the handle, the wedge is pushed between the blades to produce a lifting force up to 90,000 pounds, toppling the tree.

Nonfade Car Radio

There's no fading of volume in a new car radio when the automobile passes under bridges or viaducts. The radio, made by Motorola, has a built-in control that maintains a constant output of volume from the speaker.

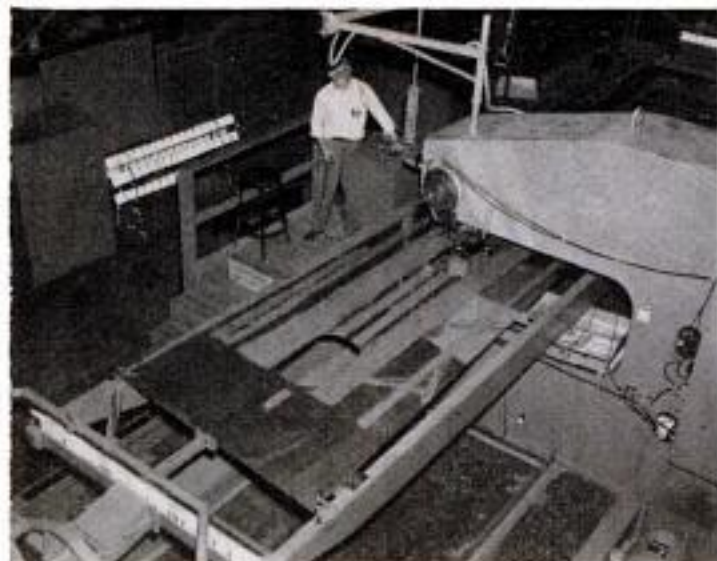

Movie Film Operates Automatic Riveter in Aircraft Plant

Ordinary 35-mm. motion-picture film serves as the "brains" of an automatic machine that rivets aircraft parts. Perforations in the film are felt by mechanical fingers, which relay the information to the drilling and riveting head of the machine.

Five different channels are perforated in the film. The machine, used by Convair, is guided by the film strip and drills, counter-sinks, selects the proper rivet, inserts the rivet and sets it. One man merely tends the machine instead of operating it.

Artificial Stream Carries Sugar Cane Across Hawaiian Jungle

Few strangers can guess the purpose of an intricate structure that towers for miles above the jungle and rugged terrain bordering the Hamakua coastline of Hawaii Island, Hawaii. It's a sugar-cane flume, in

which cane is floated from the coastal fields to the mills below. The flume is a necessity for there are no streams large enough for boats and no other suitable means of transportation.

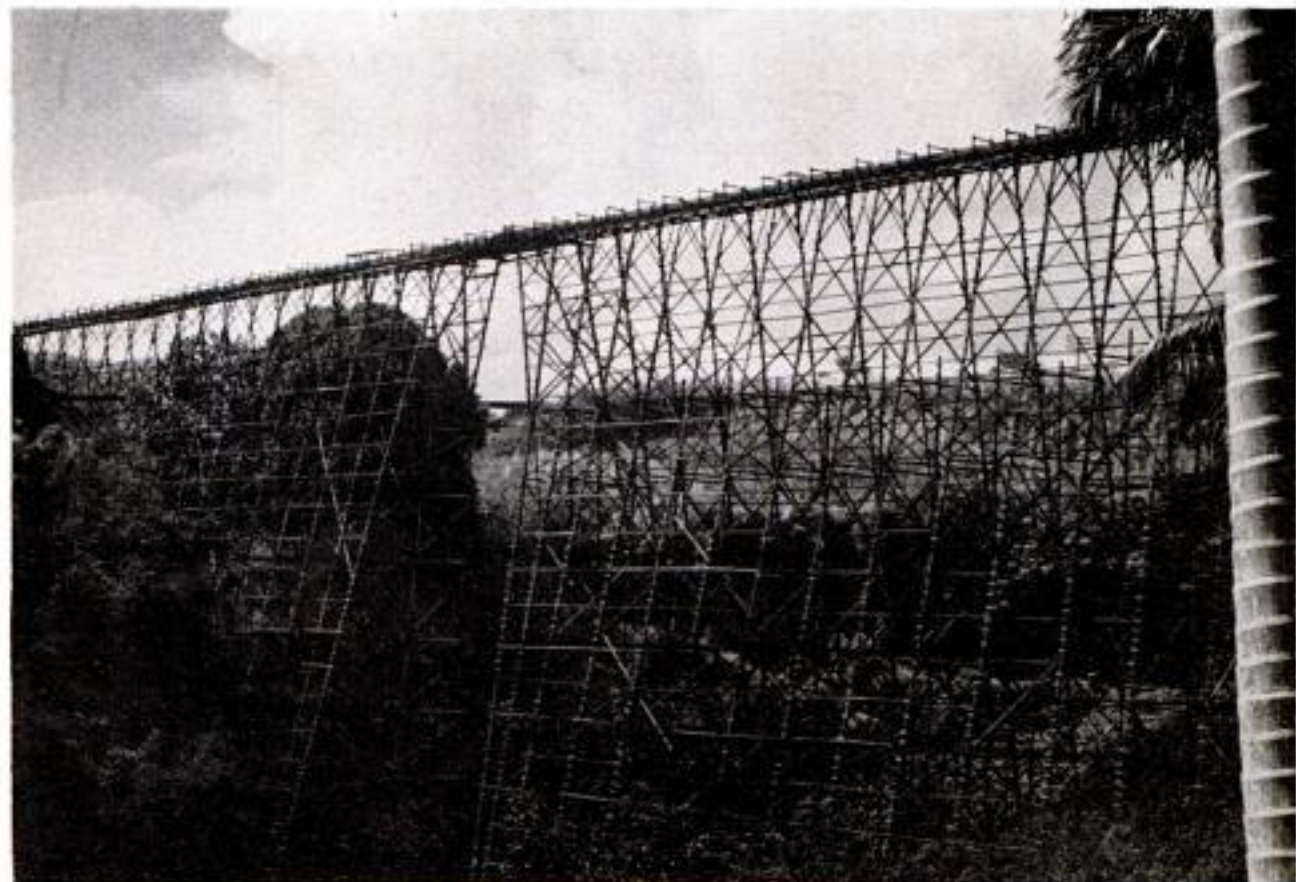

Reserve Officers "Sail" Miniature Navy Around Foot-Deep Ocean

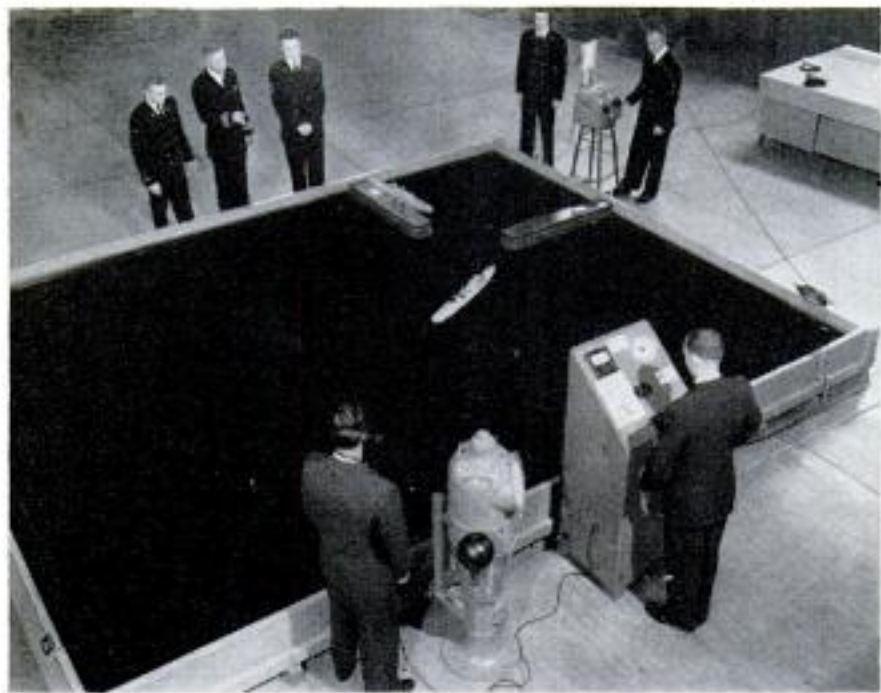

Future Navy officers "sail" a miniature ocean at the University of California in Berkeley. The men, members of the Naval Reserve Officer Training Corps, learn to handle big ships by handling models that float in a foot-deep tank of water measuring 18 by 25 feet. Along the sides of the tank are full-size controls which the future officers operate upon command. The miniature ships respond to the controls. The little "ocean" is so successful as a training device that the Navy plans to build a similar one at the Annapolis Naval Academy.

Self-Propelled Howitzer Roams Any Terrain a Tank Can Travel

Fast firing and high mobility are features of the Army's new M-44 self-propelled howitzer which can go anywhere a tank can go. The 31-ton member of the new "light-tank family" has a top speed of 35 miles per hour, will climb 30-inch obstacles, cross trenches 72 inches wide, ascend a 60-percent grade or ford streams 42 inches deep. A six-cylinder, air-cooled engine

powers the unit. It takes the five-man crew about a minute to fire each round in the 155-mm. howitzer. The unit is said to be the Army's most mobile medium howitzer, and can be put into action faster than any other medium field-artillery piece. It is primarily an artillery-support weapon, but can be used for devastating direct firing in support of advancing ground troops.



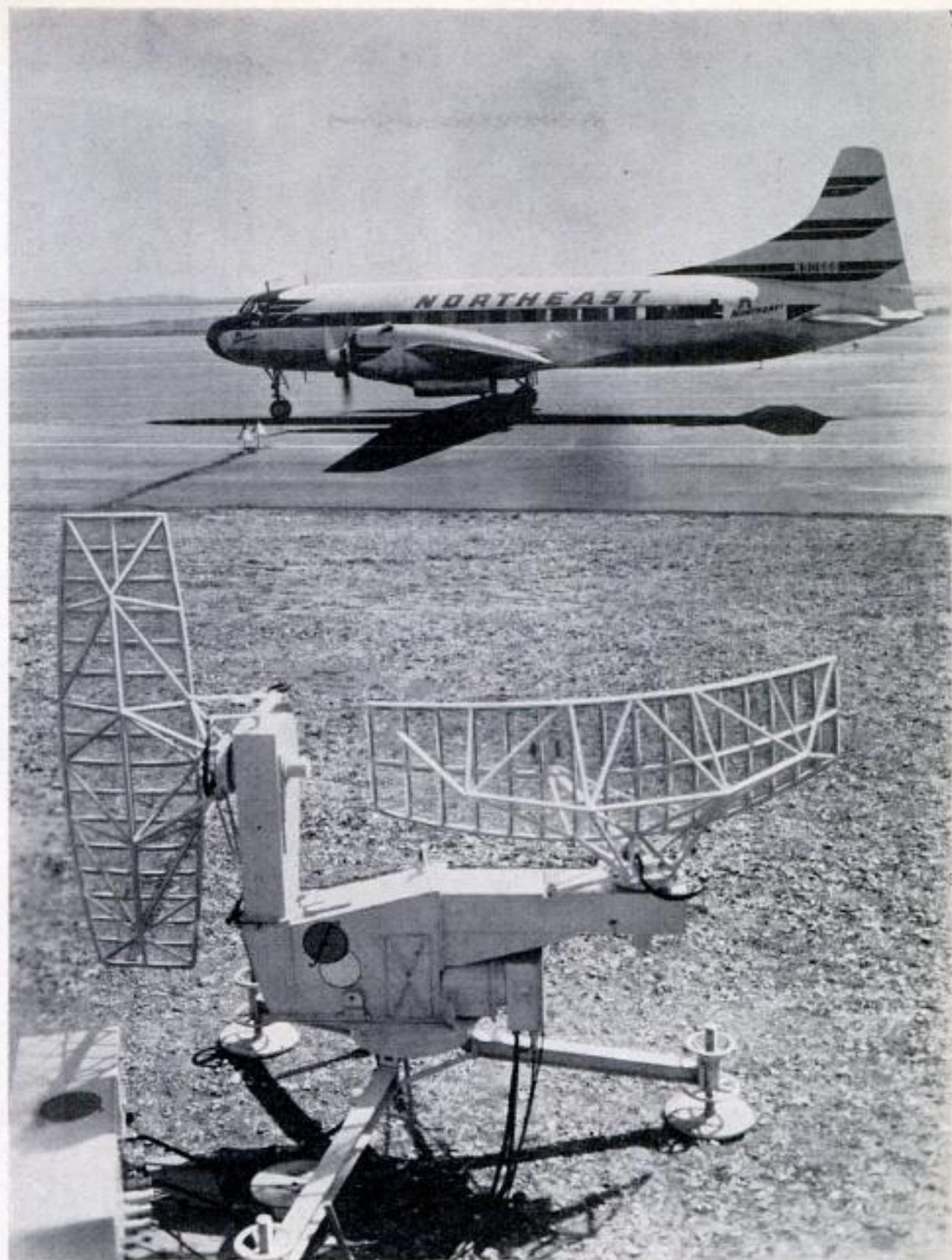

Portable Radar Unit Designed Especially for Small Airports

Almost any airport can afford a portable radar unit that can be set up in six hours and moved in 30 minutes to another runway. The approach-radar unit, built to military standards of ruggedness, features simplicity of operation and low cost. The device computes flight paths electronically

and is adjustable to a wide range of approach angles and distances. The unit, located 2000 to 10,000 feet from point of touchdown, has an accuracy of plus or minus 20 feet at touchdown. The portable unit can also be placed as far as 800 feet away from the center line of the runway.



Crowell photo

Like a covered-wagon train of pioneer days, a mobile oil-exploration unit ventures into the wide-open spaces

The covered wagon gives way to the drillers' caravan, and the Northwest is a frontier again. First it was

By Rafe Gibbs

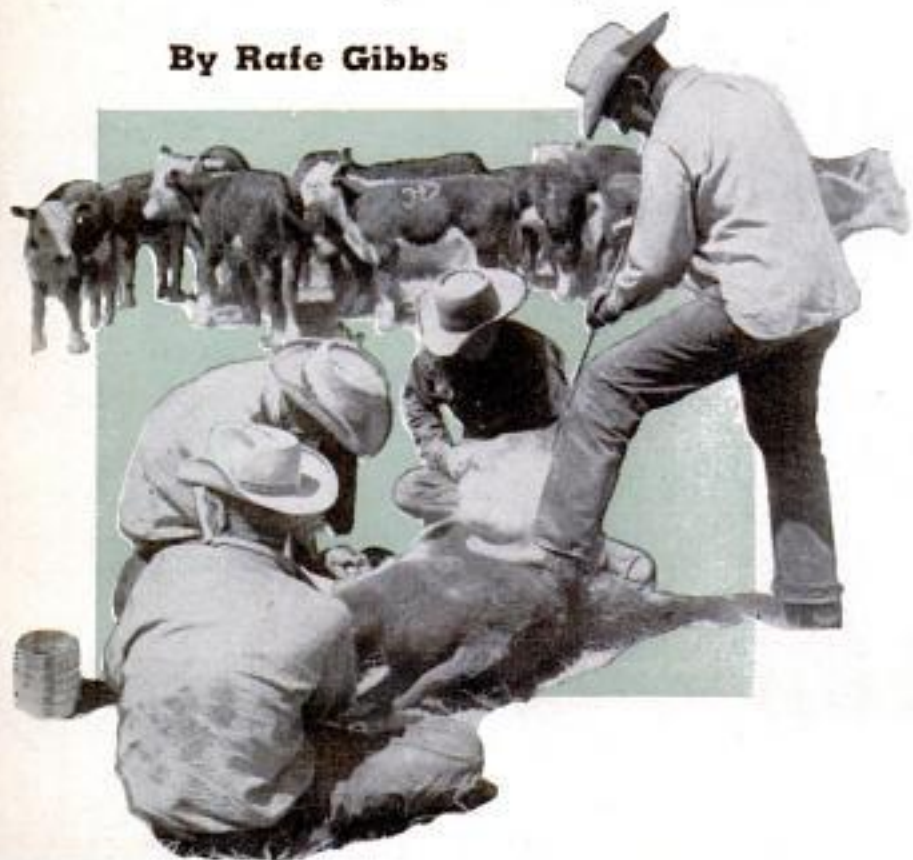

**BUFFALO,
CATTLE—
and now,
OIL**



Toxaco photo

Thunder in the "back forty"—as survey crew explodes dynamite charges and measures the ground echoes with instruments to learn the nature of underlying rock



Map shows rough outlines of Williston Basin. Over 350 strikes have been made since the first in 1951

REUBEN MOLLER, the shoeshine man in the basement of the Northern Hotel at Billings, Mont., flipped a brush from left hand to right and commented:

"Changed . . . that's what has happened to this whole country 'round here. Changed right here in my shine chair, too. Cowboy talk I could understand, but when the customers get to chinning now 'bout drilling blocks and casing scrapers I just slap on more polish and say nothing."

For 25 cents, I received both a shine and a summation of what is happening today in the Williston Basin and its fringes. Forming the nation's most booming oil frontier, the basin sprawls over 250,000 square miles of North and South Dakota, Montana, Saskatchewan and Manitoba. Nowhere is the American scene changing more rapidly. Nowhere in the United States is there more opportunity for development.

Alfred Jacobsen, president of Amerada Oil Company, put it this way: "The Williston Basin is not just another oil field. It is a whole new oil province."

Jacobsen gambled more than a million dollars and four years' time in the basin to win in 1951 with Discovery Well No. 1. Now, only three years later, the United States' section of the basin has more than 350 producing wells in 26 widely scattered fields in three different states.

In Bismarck, N. D., you get the feel of a once-tired land now charged with the throbbing energy of giant oil pumps. You notice oil brokers borrowing the shade of the hotel's marquee to ply a fast-talking curb trade in mineral rights and leases.

Then you hit Williston, N. D.—where it all started. The town lies comfortably on a terrace between the lowlands of the Missouri River and the hills and prairies. In some years, more than a million bushels of wheat were handled at Williston, which had a population of about 7000. In some years—when the rains didn't come—spiders spun their webs in the upper parts of the big grain elevators.

The years of the big dust storms blew some disillusioned folk right out of the area. For those who did not or could not

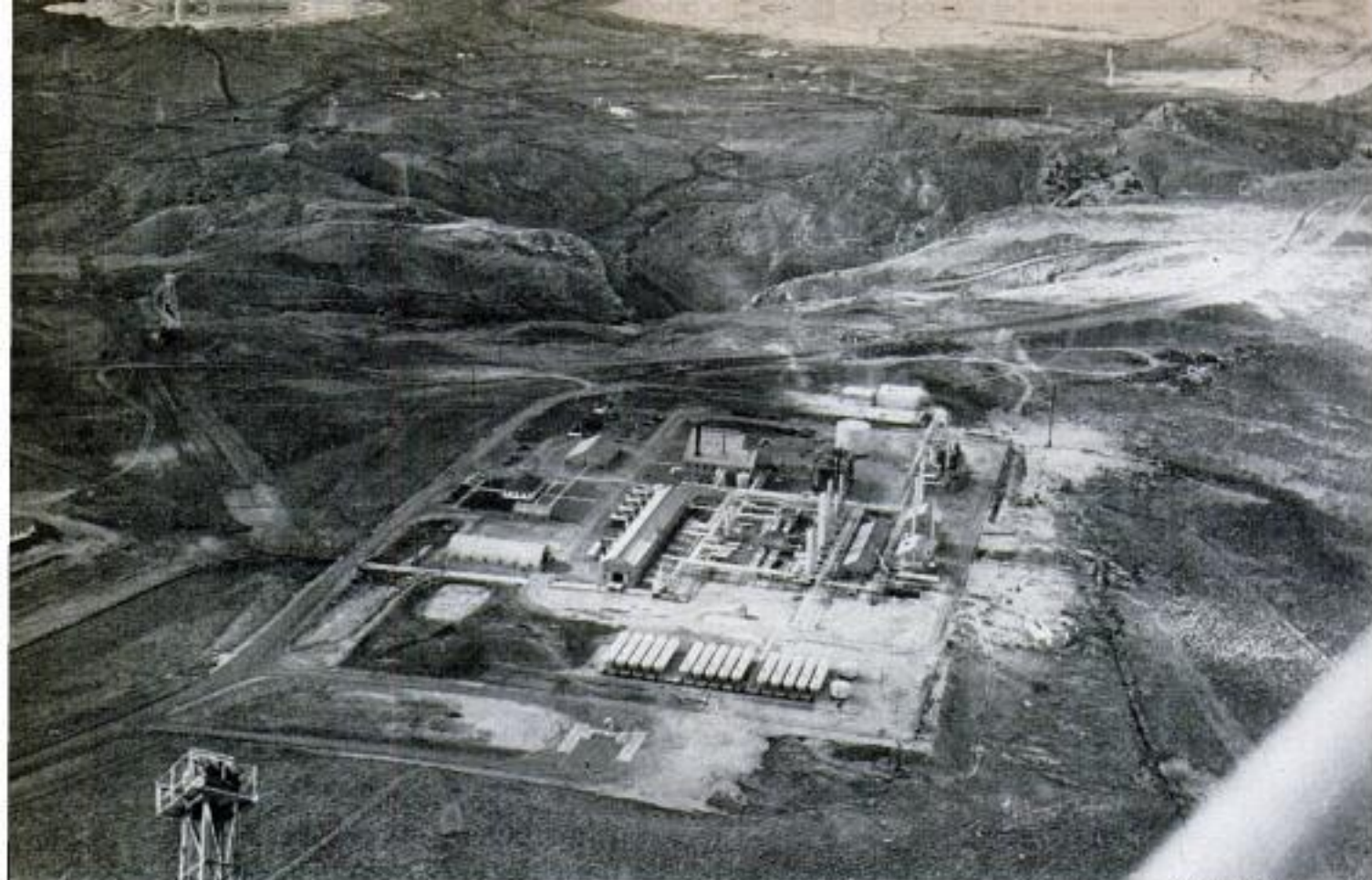

Crowell photo

New industries in the area include a gasoline plant in the Cabin Creek oil field of Montana

Oil derricks and storage tanks mark locations of 26 scattered oil fields

Crowell photo

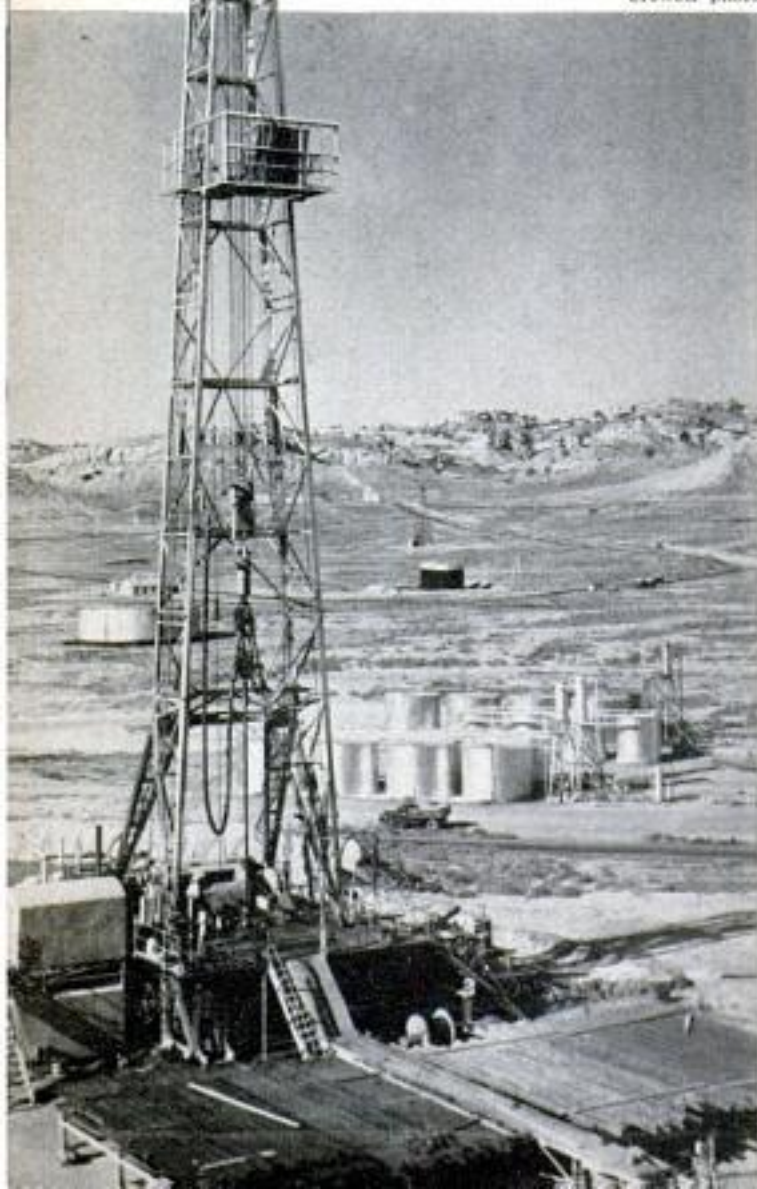

leave there seemed little hope for the future, especially in oil.

In the thirties, one independent wild-cattling outfit after another figured there just had to be oil in the basin, which forms the largest single volume of sedimentary rocks in North America, measuring hundreds of thousands of cubic miles. Millions of dollars were poured down dry holes.

Then, in 1946, Amerada, biggest independent company in the United States engaged exclusively in finding and producing oil, started explorations. After four years of testing and mapping, Amerada's experts figured they had a likely spot on the Clarence Iverson farm about 30 miles northeast of Williston.

On April 4, 1951, Amerada brought in the basin's first oil gusher. Soon representatives of other oil companies, brokers, "rough-necks" who drill, "roustabouts" who man the pumps came like the locusts North Dakota had known in other years. Today 80 percent of all potential oil land in the basin is reported under lease. Shell Oil Company alone has leased more than 8,000,000 acres.

While the big rush was on, a farmer could hardly plow around his field without an oil-company representative approaching him. Lease rights—in effect, oil-hunting licenses—shot up to \$25 an acre. Some millionaires were made, and many speculators "turned a fast buck." Two men from Bismarck with only \$1250 to invest leased all the land they

could, then shortly sold the leases for \$56,000.

Williston's population has now almost doubled to pass the 12,000 mark. More than 250 new businesses have been added since Oil Strike Day. Particularly short is housing. An unfurnished house that once rented for \$40 a month is now good for \$140. Bank deposits in the area are up 25 percent.

Farmers with oil or oil possibilities are generally playing it safe. There are new high-priced cars parked in the old barnyards, but the owners are as likely as not to be out riding a tractor. Maybe it is because they remember the lean years of the drought period and fear that oil as well as farm crops can dry up.

In 1936, while driving through the Williston area, I noticed a farmer harvesting his drought-stricken hay crop. He had attached a basket somewhat like that used on lawn mowers behind his horse-drawn mowing machine to catch the withered bits of alfalfa that would otherwise have been lost in the dust. I like to think that maybe *that* farmer has oil on his land today.

At Glendive, Mont., I got a good view of the changed pattern on the

(Continued to page 262)

Oil refinery at Laurel, Mont., is close to Billings and transportation facilities



Imperial Oil photo

Helicopters are used to expedite the search for oil in rugged country. Over 50 oil companies are searching the Williston Basin, have spent millions more than they have so far received from oil. Below, a former ranch hand guards an isolated pump

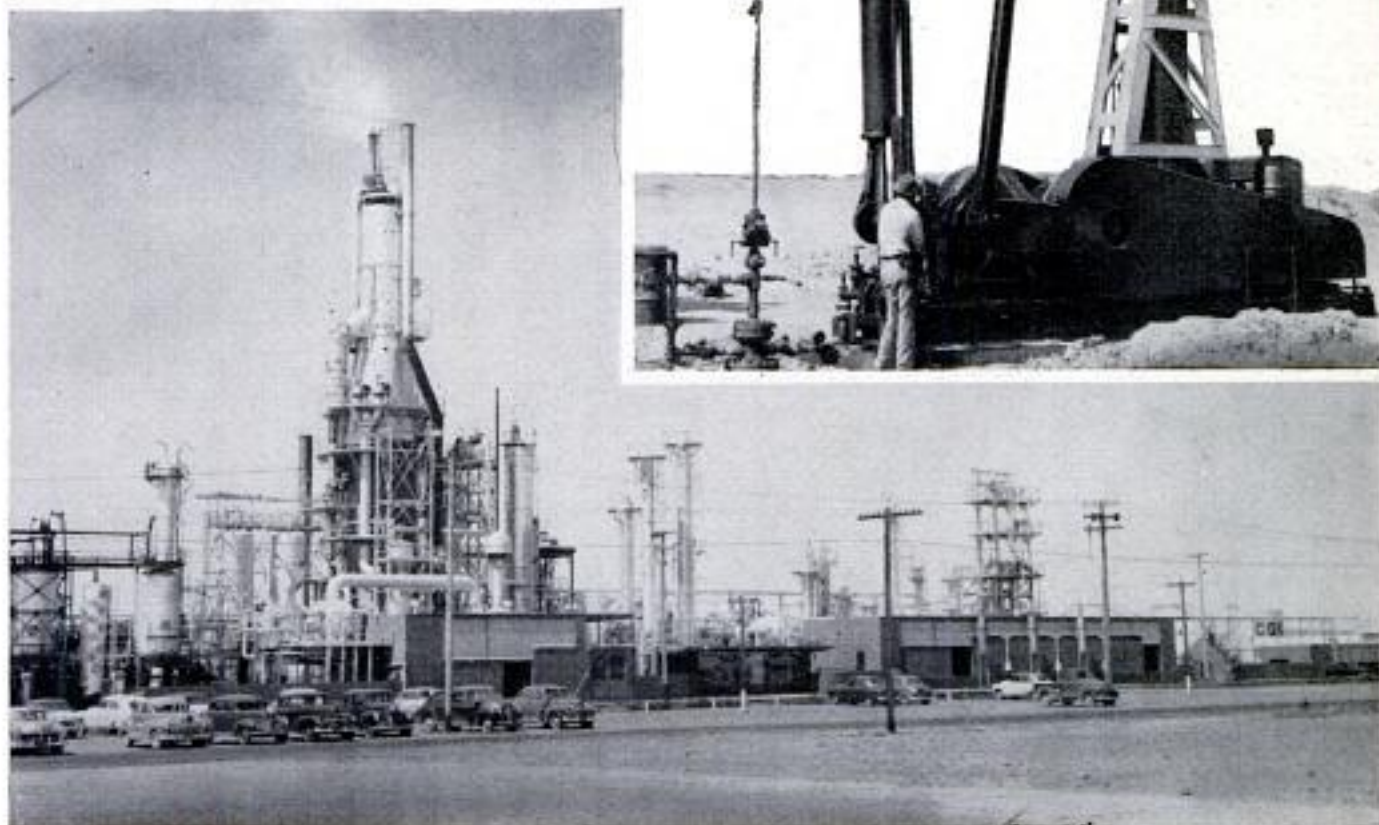

Television-Telephone Permits Face-to-Face Long-Distance Calls



You can see the person you're talking to on a new combination television-telephone—even if he's across the continent. The system is being offered to large industrial concerns for interplant use. For distances up to several miles, the two picture circuits and the two voice circuits are all carried by a single shielded wire, using different frequencies for each circuit. For greater distances, the circuits are carried by standard large coaxial cable or by microwave relays. There are no technical objections to transcontinental TV-phone hookups. Each person views himself as well as the other party on a split screen, allowing each to adjust his end of the circuit.

Concrete Mixer Driven by Tractor

No wheelbarrows are needed with a mobile concrete mixer that is pulled by a tractor and driven by its power take-off. It is designed for farm use. To speed operations, the mixer keeps turning as it is being moved to the job. The 7½-cubic-foot drum will deliver three to four cubic feet of mixed concrete per minute. It can also be used to mix feed, seed or fertilizer or even wash vegetables. A drum cover clamps over the opening during special mixing jobs.

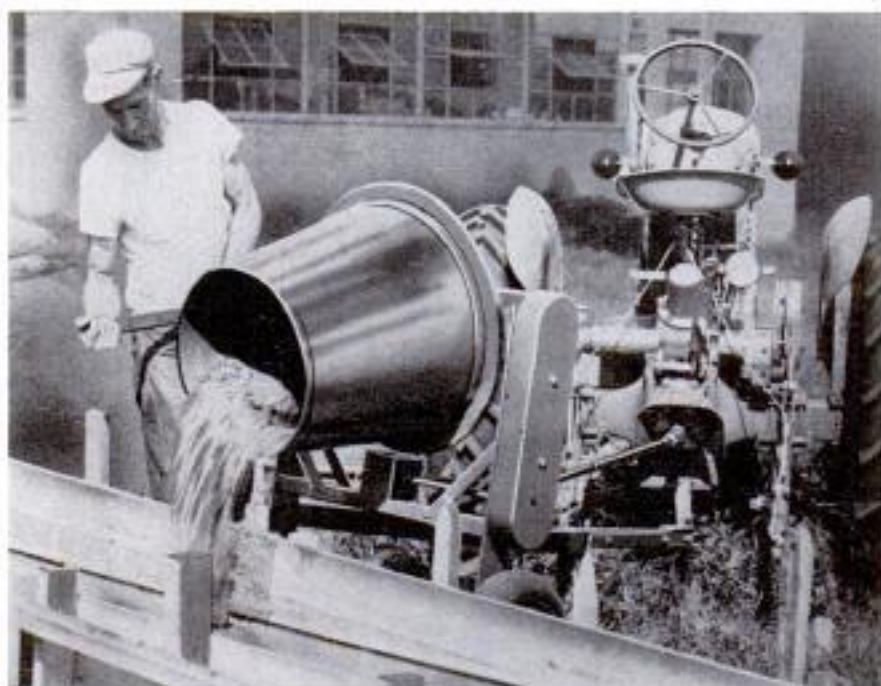

Dashboard Padding Reduces Reflections

Annoying reflections from the top of automobile dashboards are eliminated by a plastic pad that is installed in one minute without tools. The pad surface is available in a variety of colors and its stippled surface prevents the reflection of sunlight into the driver's eyes. To install, you remove a paper backing and press the pad firmly in position on the dashboard.

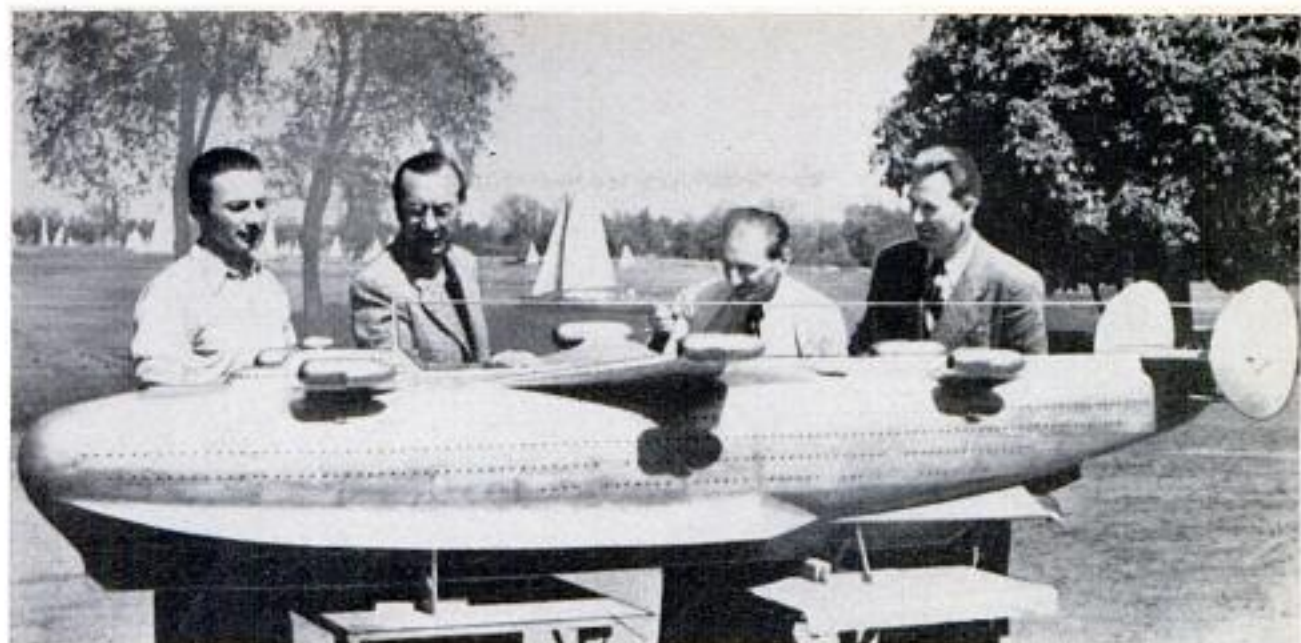

German Designer's Ocean Liner of Tomorrow Resembles Airplane

Ocean liners of the future will resemble airplanes in many ways, according to Wilhelm Fechner, a German designer. He and his assistants have built a large scale model of a ship which they hope will be built. The full-size ship would be more than 400

feet long and would weigh about 11,200 tons. It would be powered by 72,000-horsepower turbine engines, giving it a top speed of more than 80 miles per hour. Fechner says that after it reached a certain speed it would rise and plane on the surface.

Rotary Mower for Tractor Speeds Through Tall Weeds

Attached directly to the power take-off of a Ford or Ferguson tractor, a rotary mower cuts a five-foot swath through the tallest weeds at high speed. The wheels of the tractor are turned inside out to make room for the rotating blade. A plywood shield is mounted to the hydraulic lift arms and extends over the whirling mower blade. The mower is popular in the Northwest where orchardists use it to cut down tall weeds around fruit trees at high speed.

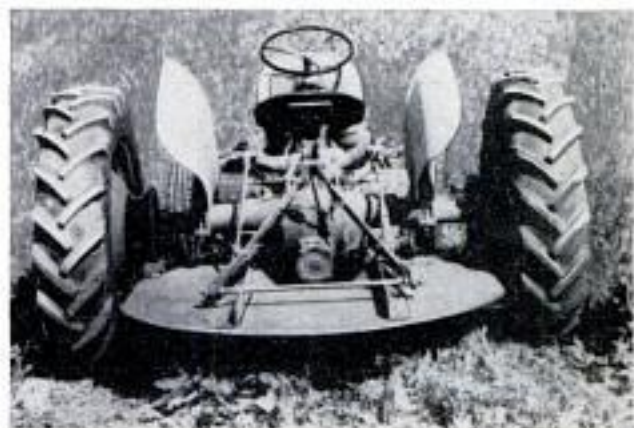

Electric Reading Aid Moves Marker Down Page

You can increase your reading speed up to 300 percent with a silent electric machine that moves a plastic marker down the printed page. The machine is adjusted to the number of words per line and set for the number of words per minute. As reading speed increases, the machine is adjusted to a faster rate.

☐ Built into the door of a new refrigerator is a tear-off dispenser for aluminum foil, which protects and speeds the cooling of refrigerated foods.



Tubeless Tire Is Repaired by Sealing Hole With Rubber Plug

Holding air without a tube or even a tubelike liner, a new Goodyear tire can be repaired like a tubeless bicycle tire. The patching technique resembles the rubber-band-gun system of plugging holes in bicycle tires. There are a needle, some cement and rubber plugs in the repair kit. A plug is hooked over the needle, dipped in cement and forced into the hole. When the needle is withdrawn, the plug stays in, sealing the hole permanently. The tire can be driven on immediately. No tubelike liner is needed because the tire carcass itself has been made impervious to air by a special coating of the fabric in manufacture.

No puncture sealant is needed. The tire weighs less than a tire-and-tube combination, runs cooler and wears longer, Goodyear officials report. It can be installed on any rim except those with wire wheels. Although not punctureproof, the tire will not lose air when punctured by a nail as long as the nail remains in the carcass. Should the nail come out, the repair is quickly made while the tire is still on the wheel. There is less likelihood of a blow-out because there is no tube to wear or chafe. In violent starts and stops, there is no tube to shift and possibly tear out the valve stem, another cause of blowouts.

Portable Buildings Utilize Strength of Box-Stressed Paperboard

Requiring no interior supports, dome-shaped structures of box-stressed paperboard have been adopted for a wide variety of uses by the Marine Corps. Light enough to be transported by helicopter, small paper buildings can be used to shelter per-

sonnel and equipment. Larger structures, such as revolving aircraft hangars, have been made in scale model. Paper-dome buildings were developed by R. Buckminster Fuller, who is noted for his architectural innovations.

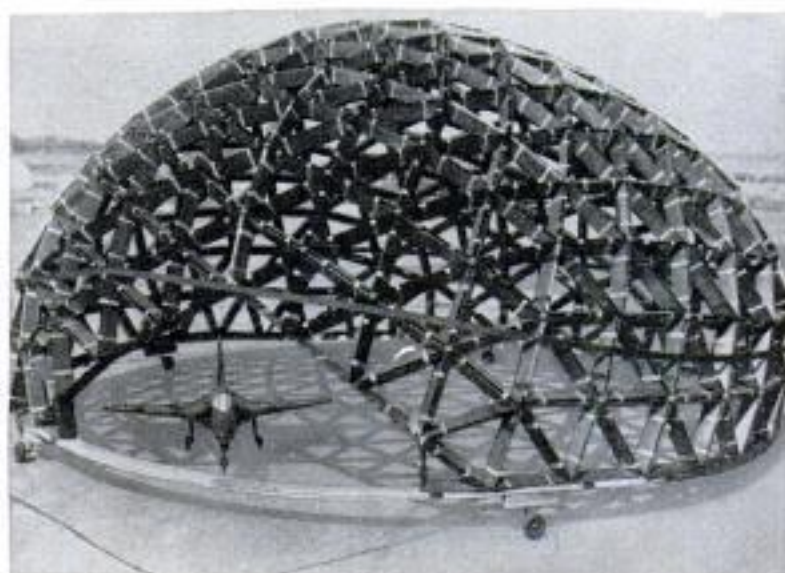
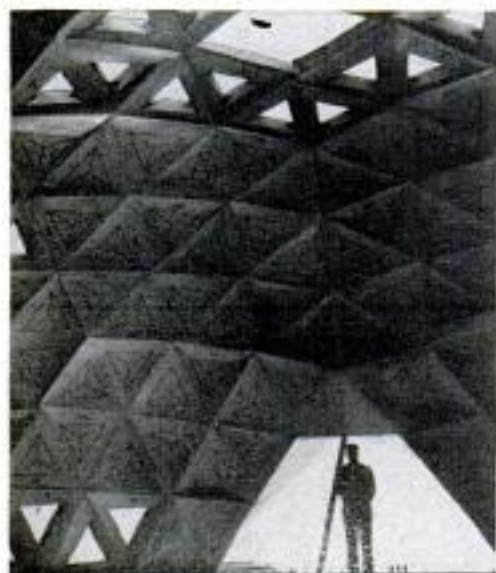

Torpedo Tries Again If First Pass Misses

Acoustics guide an experimental "homing" torpedo to its target so surely that it will turn around if it misses on the first pass. It is being tested in the Navy's new electronic torpedo tester which charts the movements of the "tin fish" just as if it were actually in the water. Using this device costs only \$4 per test, far less than a test at sea in which ships and submarines are used.

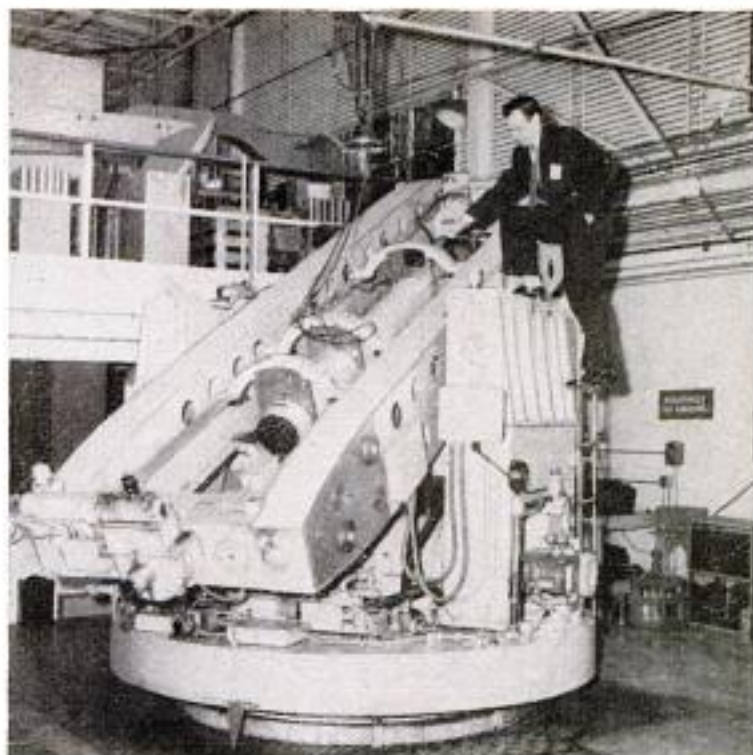

Crane Made From Scrap Lifts Farm Machinery

When heavy farm machinery breaks down on Willowbrook Farm, Erie County, Pa., the Grimshaw brothers are likely to roll out a 20-foot homemade crane to lift the equipment for making repairs. Using an arc welder, they built the crane mostly from scrap iron and bar steel and mounted it on a discarded auto axle. The entire unit, equipped with rubber-tired wheels, is readily moved to the field with a light tractor; cable is wound or released by a geared, hand-powered winch.

Venezuelan Home Anchored to Hillside Seems to Float on Air

Plenty of sunshine and fresh air are among the advantages of a strange-looking house perched on a hillside near Caracas, Venezuela. The 13-room mansion was designed by a local architect and cost between 700,000 and 800,000 bolivars (\$210,000—\$240,000). Its owner is Monreglio Oreste, a grocery-store owner and caterer who arrived in Venezuela six years ago from Italy "dead broke."

Examination of children's hair with a polarizing microscope and a refractometer roughly indicates the age and sex of the child from whom the hair came, according to a Washington University report.



Hamilton Wright photo



Chief Petty Officer McDonald, inventor of the jet gun, demonstrates how simple it is to reload the weapon

JET GUN FOR FROGMEN

FISHING CAN BE as relaxing as an armchair under a willow tree or as exciting as a jet plane. Skin divers prefer excitement with their fishing. Something new in this exciting sport is a jet-action under-

water gun designed by a U.S. Navy officer. So the big ones won't get away, a nylon line is tied to the arrowhead. If his aim is good, the diver pulls in his fish



water gun designed by a U.S. Navy officer.

Chief Petty Officer Otis McDonald saw an underwater powder gun owned by a skin-diving friend of his. It was beautiful, but expensive—\$600 was its price. McDonald thought he could do better than that and, being an inventor by hobby, he went to work on it. Right off the bat, he disagreed with the basic principle—he didn't see why the propelling charge should be in the breech, as it is in the regular rifle.

The novelty of his gun lies in this principle—it is driven like a rocket by jet propulsion. McDonald reasoned that underwater the thrust given a hollow shaft would be greater than the push given to a solid one. Behind that reasoning lies the secret of this inexpensive but powerful weapon.

A blank cartridge is inserted in a removable arrowhead, which is then attached to the end of a hollow aluminum shaft 21 inches long. This shaft, with arrowhead attached, slips into the barrel and fits over the firing mechanism.

The hammer, as in an ordinary gun, forces the firing pin to explode the powder charge. Unlike

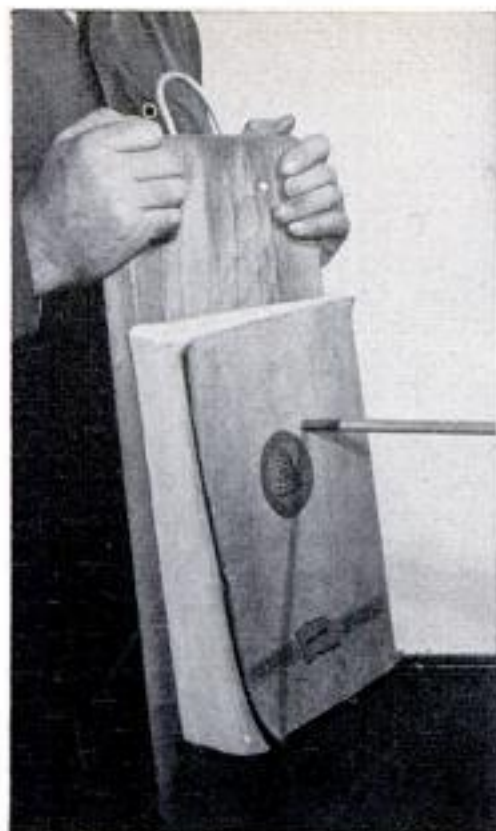

Arrow went through telephone book and into board from 20 feet. It is silent

an ordinary gun, however, the firing pin is enclosed in a tube as long as the barrel so it can reach the cartridge at the muzzle of the gun. The hollow aluminum shaft (to which the arrowhead was attached) fits over this tube.

These changeable arrowheads permit the user to vary his shots. For big fish, he can use large heads with large charges; for small fish, smaller ones will do. If he misses the first shot, all he has to do is to slide another "arrow" down into the barrel, cock the hammer, aim and shoot again. (The hollow aluminum shaft with head attached looks so much like an arrow that it is called one by the inventor.) It is not necessary to surface to recock the gun.

Unlike many harpoon guns, the McDonald design actually likes the water. Some powder guns with the propelling charge in the breech have to use most of their power pushing the water out of the barrel. This gun gets its thrust from the jet action of the charge against the water behind it. It is completely silent and has no kick.

The gun is designed to accommodate cartridges the size of .22-caliber shells. ★ ★ ★

OCTOBER 1954

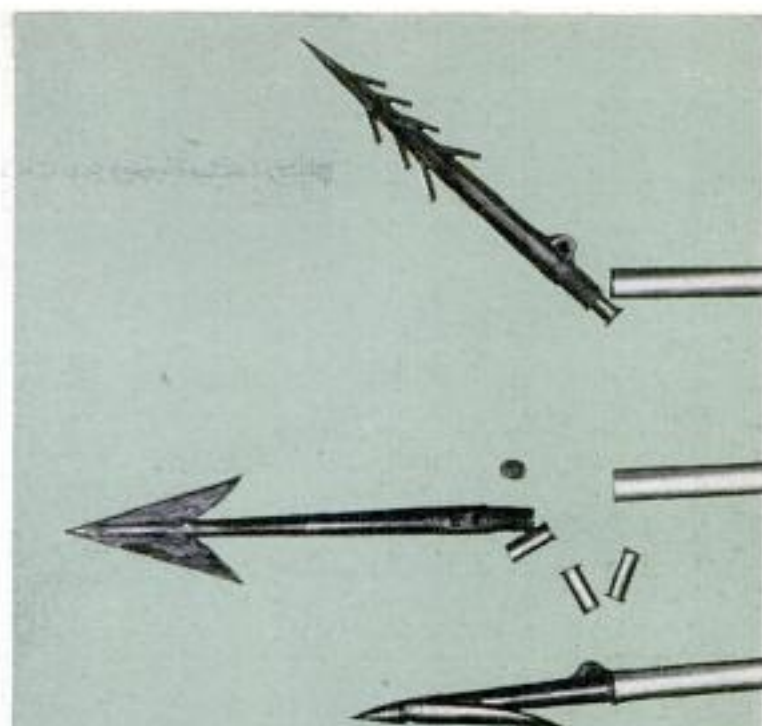

Changeable heads are shown with the blank cartridges used to fire them. Diver can carry several preloaded arrows with him. Shell fits snugly to keep powder dry

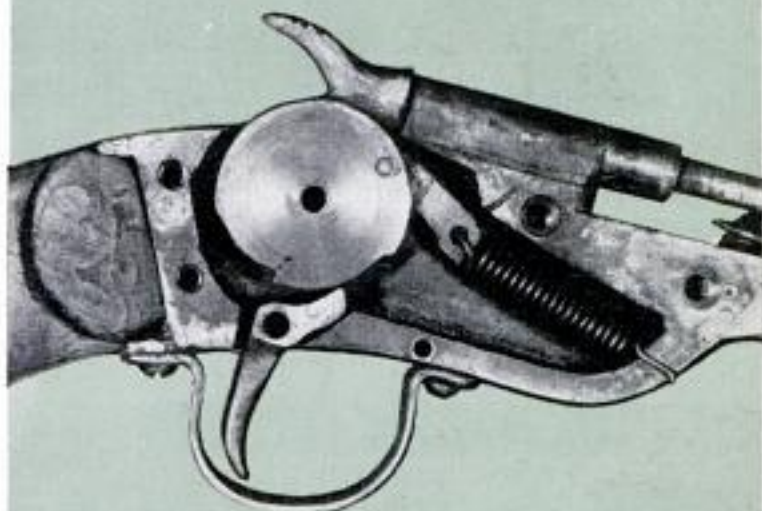

With very few moving parts, the gun is simplicity itself. Hammer hits tube, driving firing pin into shell



Here are the parts shown disassembled. Third long tube from the top is the flared barrel. Most of the gun is made of stainless steel or bronze to minimize corrosion

Detroit Listening Post



By Leo Donovan

DON'T TAKE YOUR EYES off the stage for a moment in the next few months. The show is about to begin and what a performance it promises to be! Never in recent years have there been such great expectations.

Here is the program with the stars named in order of their appearance:

October — Studebaker, Chevrolet and Pontiac.

November—Ford, Buick, Cadillac, Plymouth, Chrysler, DeSoto, Dodge, Imperial, Oldsmobile, Lincoln, Mercury, Rambler and, perhaps, Hudson.

December—none.

January—Packard, Nash.

As you can see, the Thanksgiving turkey will step aside this year. Automobiles have taken over the month of November.

What to Expect

Here are just a few of the reasons why 1955 will be the industry's most exciting announcement season:

There will be at least four different all-new V8 engines, making the V8 just about standard throughout the industry.

There will be a car with long-awaited (in this country, that is) torsion-bar suspension on all four wheels.

There will be an all-new prestige car so carefully put together that each automobile will get two road tests and tune-ups before leaving the factory. When a buyer gets it, it will be in peak condition.

There will be wrap-around windshields on all but two or three cars.

All cars will offer tubeless tires.

Horsepower ratings will zoom. Everybody is waiting for the other fellow to make his claim so he can make a bigger one! It looks as though 150 horsepower will be a low figure, something the "small" cars will offer. There's no doubt the big cars will exceed 250 and approach 300 horsepower in some models.

Sporty station wagons (like the Corvette Nomad) are in the works, but probably won't be announced until spring.

What Does the Public Want?

Despite the horsepower race, the Big Three are aiming for superior styling, lusher exteriors and interiors. Sales experts, reviewing postwar sales of various makes, claim that styling exceeds performance as a means of winning customers.

What the public also wants, unquestionably, are lower prices. Manufacturers are wary about predicting what may happen to 1955 price tags. They'll tell you that production costs have not declined enough to merit any reduction. And anyway, they say, the buyer is getting the best value in history now.

But competition at the retail level is expected to keep prices flexible enough for most bargaining customers. And there is the anticipation that factories will allow dealers enough delivery bonuses and sales prizes to permit more profitable trading.

Apparently, manufacturers have concluded that the public, despite protestations about traffic jams and crowded parking areas, does not want a smaller car. The only dimension that will be smaller in tomorrow's automobiles is over-all height. Cars keep getting lower, but longer. Pontiac, for example, is said to be three inches lower in 1955 than in 1954.

Pontiac Is All New

Pontiac, incidentally, has a completely new car—body, frame and engine. It is the only General Motors car to show declining sales in 1954 and that won't happen again, Pontiac officials state.

It is loaded with styling tricks, including a novel treatment of the characteristic chrome strips that identify it from any angle. Its V8 engine is not, as predicted, a copy of the Olds Rocket. It is all new, all Pontiac and, the company says, all power!

Chevrolet's 1955 models, powered by a new V8 engine (the overhead-valve six will still be available with added horsepower), outshine their swankiest predecessors and resemble in elegance higher-priced models of the current GM family. They are lower, of course, and have a front suspension that Chevrolet is having trouble naming so it won't sound like a competitor's.

Ford and Mercury are not going to slacken their drive for sales supremacy. They have all-new bodies, greatly increased horsepower. Ford is renaming its top line and giving it much more luxury. Mercury will have a new top line. Both will have a startlingly different hardtop.

Chrysler makes its strongest bid since the war and is in a very promising position: (1) Because its dealers are not currently overstocked with 1954 models; and (2) because of its drastic styling changes.

Self-Leveling Combine Works Up, Down and Around Slopes



Idaho Machine and Sheet Metal Works photos

A self-leveling combine in position for downhill work. The driver's seat is reversed for this operation

ALTHOUGH IT MAY LIST like a sinking ship on level ground, a self-leveling combine has proved a most practical aid for farmers in the fertile but hilly Palouse area of northern Idaho and eastern Washington. The mechanical and hydraulic-leveling mechanism is activated by an 88-pound pendulum weight suspended by the driver. It keeps the combine level, even though it may be operating up or down, or on the side of a steep hill. Loss of harvested grain is eliminated and the danger of overturned machines is greatly diminished. The self-leveling combine, which replaces earlier machines that had to be kept on an even keel by hand, was developed through the cooperative efforts of the Idaho Machine and Sheet Metal Works and the International Harvester Co.



The combine can adjust for any contour. Here it is set to work down a hill that slopes to the left



John A. Luedke photo

Ready to work up a side slope, the combine pitches forward. Inset: Actual operation in this position



OWNERS REPORT:

We asked Corvette owners from coast to coast about their cars. Here is what they say

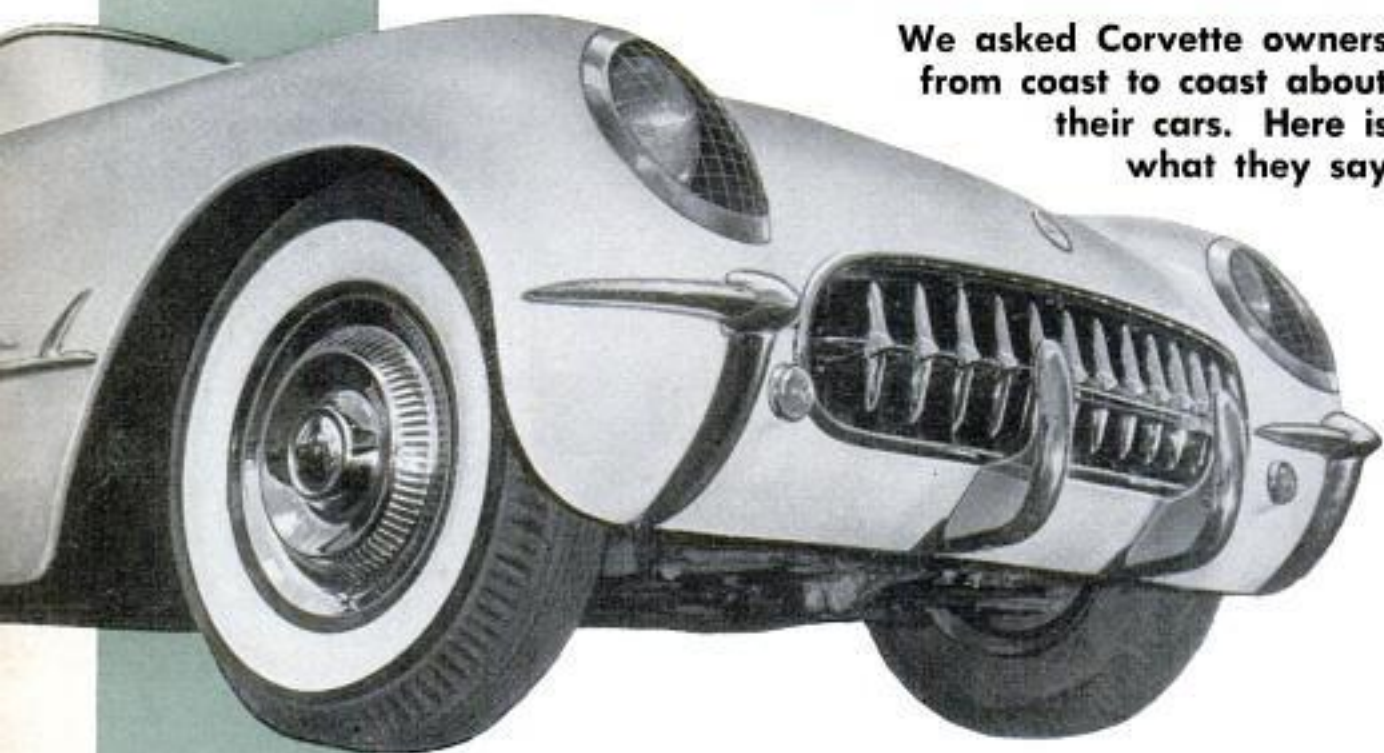

Here are its good points:

"Safest car I have ever driven. Built for comfort on the highway too."

New York coal dealer

"Corners very well. Stays flat. Except for competition use, it leaves nothing to be desired."

Idaho personnel director

"Just good 'fun' to drive."

Illinois merchant

"Best looking sports car I've seen for the money."

California air line Captain

And its weak points:

"Needs serviceable, rainproof top with windows in the doors."

Georgia physician

"Dealers not equipped to repair plastic-body cracks in most cases."

Illinois Sports Announcer

"Rain leaks into door compartments and onto floor. Top too hard to put up. Carburetors don't sync well enough."

California Restaurant Owner



CORVETTE IS A FINE "FUN" CAR BUT IT HAS ITS LIMITATIONS

By Corvette Owners

WHEN OWNERS OF foreign sports cars praise an American car, that's news. And that is exactly what happened. Of the Corvette owners taking part in our survey, 36 percent now own or have owned a foreign sports car. And, amazingly enough, over half of them rated the Corvette better than their foreign cars. Only 22 percent said it was not so good, while 19 percent described it as equal to the foreign product.

"I have driven many foreign sports cars. Over-all, I prefer the Corvette, since I do not race. Corvette beats them all in riding quality and handles just as good," said an Ohio manufacturer's agent.

"If I were racing it might be different, but none of the foreign sports models I've ridden in will equal it for comfort and ease of ride and still give roadability and acceleration."—Idaho dairyman.

"I have owned five sports cars and rate the Corvette more dependable although

not as good to drive."—Illinois executive.

"I have owned foreign sports cars and rate the Corvette better in serviceability, riding comfort and looks. The top fits better too."—Michigan merchant.

"The Corvette is better in traffic, better all around except for top speed."—Kansas oil man.

The consensus seemed to be that, unless the car is to be used in competition events, the Corvette offers more than foreign sports cars.

Body Leaks, Say Owners

But there were complaints about the plastic-bodied sportster. By far the biggest complaint was that the body leaked in the rain. Thirty-five percent of the owners mentioned this as their principal complaint.

"It leaks every time it rains and fills the ash trays with water and soaks the floor mat. You just cannot park it facing uphill during a rainstorm as you'll find a floor full of water."—New York designer.

By Floyd Clymer

THE CORVETTE two-passenger test car had 1406 miles on it when my road test of 465 miles was started. I drove it from Los Angeles to Santa Maria, over the winding roads to Bakersfield, returning across the hot Mojave Desert, where some accel-

eration tests and speed runs were made at Rosamond Dry Lake, and back to Los Angeles over the winding Angeles Crest Highway.

At top speed the speedometer needle hit 114 miles per hour (the speedometer dial goes up to 140, which looks good, but the

(Continued to page 360)

Corvette handles well on corners with skids easy to control. However, steering is too slow, says Floyd Clymer





Dash is poorly arranged, say some owners, with tachometer and other dials placed too far to right for easy reading



One of the major complaints was the Corvette's top. It is stored in a well behind the seat and is hard to put up

Three carburetors help boost the Corvette engine's horsepower to 150, giving the light car plenty of performance

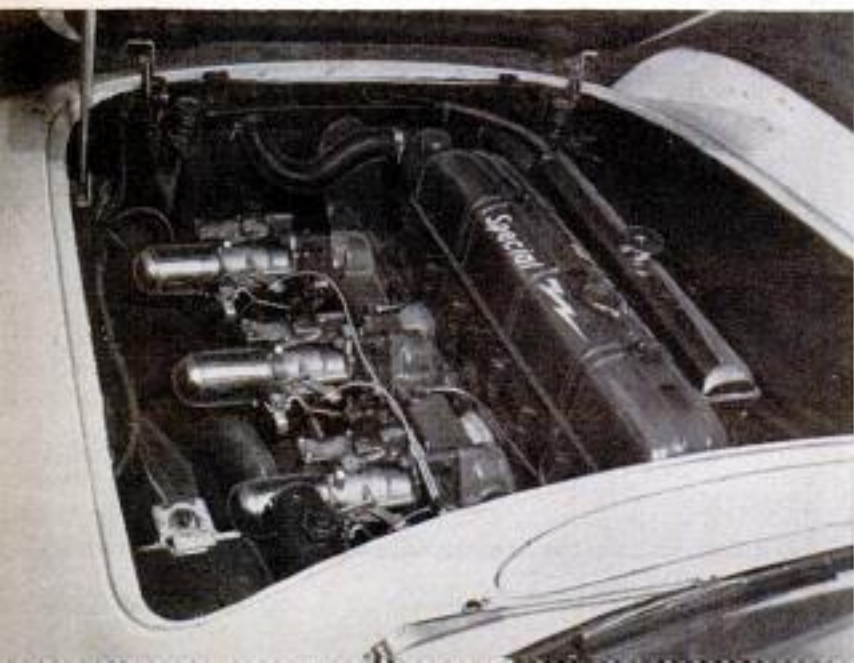

"Strictly a dry-weather car. Floor holds four gallons of water. Needs a different top and windows." — Ohio executive.

"Poor visibility in rain. Water pours all over, mainly between windows and the windshield. The top is too hard to put up." — Virginia businessman.

The top was the second most frequent cause for complaint and it is somewhat related to the complaint about leaks.

"Top too hard to put up. Should have a removable plastic top in addition." — California restaurant owner.

"Top fabric not cut to accurate measurement. The first Model-A Ford had a better one." — New York coal dealer.

"Could use a deeper well to store top. Leaks on leading edge of doors. Collects water in door compartments. Accelerator pedal too stiff." — Connecticut sportscaster.

"Roll-up windows should be in doors. Top should be automatic." — Ohio lawyer.

Styling Is Best Liked

Just about all the owners were pleased with the Corvette, praising particularly its low suspension and its ease of handling. But the one feature that appealed to most is styling.

"It is the best-looking sports car I have seen for the money. Well finished inside. The right amount of chrome. No rear-wheel pants." — California airline captain.

"The best-looking car on the road today." — California beauty-salon owner.

"The only car available that compares with foreign cars in styling." — Ohio housewife.

Performance, handling and roadability were close behind styling on the list of best-liked features.

"Very easy to handle, has wonderful pickup, excellent visibility, holds the road beautifully (especially on curves) and is easy to park." — New York buyer.

"Excellent cornering, smooth acceleration, freedom from repairs." — Michigan engineer.

"Corners very well and also sets up a four-wheel drift nicely. It gives ample warning before the rear end breaks loose and is easily corrected." — Idaho personnel director.

"I like the way it drives and holds the road." — Texas dry cleaner.

"Corners well but needs faster steering." — California clerk.



Owners from states shown in color on map give their opinions of the Corvette in the percentages below

Percentages from PM Poll of Corvette Owners

Over-all rating of the Corvette

Excellent	65%
Good	29%
Fair	3%
Poor	3%

Owners rate roadability:

Excellent	79%
Good	19%
Poor	2%

Owners rate handling:

Excellent	82%
Good	16%
Poor	2%

Owners rate structural rigidity:

Excellent	65%
Good	30%
Poor	5%

Average miles per gallon:

In traffic.....	14.9 m.p.g.
On trips.....	17.9 m.p.g.

Acceleration

Excellent	72%
Good	28%
Poor	0%

Average time from 0-60

m.p.h. 11.1 seconds

(Only 35% answered this question)

Average top speed, 109.7 m.p.h.

(Only 48% answered this question)

Owners rate Powerglide:

Excellent	60%
Good	32%
Poor	8%

Owners preferring hand-shift

..... 10%

Owners rate engine:

Excellent	57%
Good	40%
Poor	3%

Prefer some other engine.. 15%

Opinion of plastic body:

Like	97%
Dislike	3%
Would like on family car..	78%
Would not.....	22%
Have had body trouble....	31%
Have not had trouble.....	69%

Owners rate convertible top:

Satisfactory	33%
Not satisfactory.....	67%

Would prefer roll-up windows:

Yes	65%	No	35%
----------	-----	---------	-----

Would prefer more room:

Yes	26%	No	74%
----------	-----	---------	-----

Owners rate body styling:

Excellent	98%
Good	2%
Poor	0%

Owners rate brakes:

Excellent	66%
Good	31%
Poor	3%

Owners rate steering:

Excellent	74%
Good	24%
Poor	2%

Owners rate riding comfort:

Excellent	51%
Good	46%
Poor	3%

Have owned foreign sports car:

Yes 34% No 66%

Compare Corvette with foreign sports cars:

(Asked of those who have owned foreign cars)

It's better.....	59%
It's equal.....	19%
It's worse.....	22%

Have another car in addition to Corvette..... 89%

Would buy another Corvette?

Yes	61%
Might	28%
No	1%

Owners rate dealer service:

Excellent	49%
Good	30%
Fair	13%
Poor	8%

Belong to a sports-car club.. 18%

Use Corvette in races or rallies

8%

Best-liked features

Styling	42%
Performance and power....	31%
Handling	19%
Roadability	19%

Most-frequent complaints

Leaks	35%
Top construction.....	18%
Hood catch.....	13%

"Roadability is excellent. Very stable. Handles turns well, has very little float and very little lean. Steering is definitely slow. I am used to driving foreign cars, and I've owned most of them, but in a car with its acceleration, you could get into trouble with the Corvette's slow steering."—Minnesota manufacturer.

Comfort was also high on the list of best-liked features.

"It has all the comfort of a good sedan and the beauty of a sports car."—Georgia real-estate owner.

"The Corvette is the first attempt in giving sports-car features with conventional-car comforts."—Connecticut salesman.

But Is It a Sports Car?

Many owners, especially those who have owned foreign sports cars, were careful to limit the Corvette to something less than a true sports car. It is somewhere between a family car and a sports car, most seem to agree.

"Not a sports car in the true sense of

the word. But it should not be sold to people who do not understand sports cars. It is not like the family car and some might be disappointed if they expect the room, seat comfort, etc."—Illinois merchant.

"This is a real sports car as originally defined in that it can be driven to (not in) the race."—Oklahoma engineer.

Most owners agree that whether or not it is a true sports car, the Corvette is real fun to drive. As one owner, a Michigan architect, describes it: "I like the feel of driving the Corvette. It gives the pleasure one gets in sailing a boat."

Additional Complaints

"On rough roads, the hood keeps popping up. Hard to get in and out with the top up."—Oregon physician.

It should be mentioned that the hood is hinged at the front so that even though the catch might release, the hood will not fly up as it would if hinged in the rear as on the conventional car.

"Door latches won't stay in position

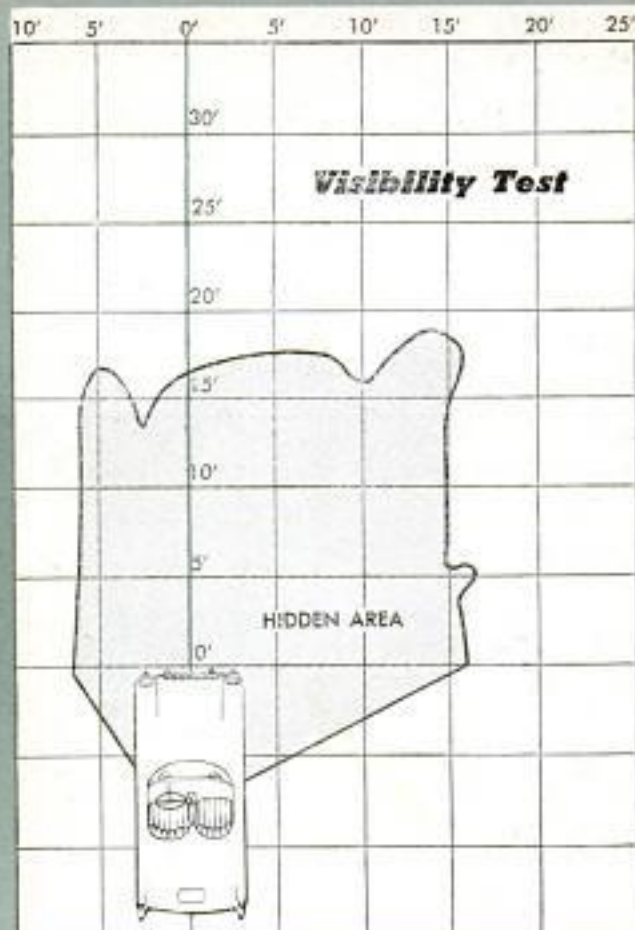

Acceleration Test

1954 CHEVROLET CORVETTE
with Powerglide

¼ mile from zero	16.4 seconds
½ mile from zero	26.8 seconds
0 to 30 m.p.h.	4.3 seconds
0 to 60 m.p.h.	11.6 seconds
Top speed by speedometer	112-114 m.p.h.
Actual top speed	105 m.p.h.

Economy Test

MILES PER GALLON
Constant-Speed Mileage

At constant 30 m.p.h.	19.4
At constant 50 m.p.h.	17.2
At constant 60 m.p.h.	15.8
At constant 75 m.p.h.	11.7

Cross-Country Mileage

Los Angeles to Santa Maria	18.4
Santa Maria to Mojave Desert	15.3
Mojave to Los Angeles (over winding, mountainous Angeles Crest Highway)	14.2

Premium gasoline used on all tests

Popular Mechanics believes that the best test drivers are the owners themselves. For their opinions, we survey hundreds of them every month and relay this information to you by these Owners Reports. In addition, Floyd Clymer road tests the cars for performance data

and the friction hood latches won't stay tight on rough road."—Texas executive.

"No fender protection. Instrument panel poorly placed. Dealers not equipped to repair cracks in body."—Illinois sportscaster.

"Foot accelerator too rigid. It is hard to give it a little gas."—Arizona rancher.

"Mechanics seem to have difficulty adjusting carburetors."—California broker.

"Exhaust coming out back has tendency to blacken rear of car."—California service-station owner.

"Exhaust fumes bad inside car when the top is up."—Illinois housewife.

"Carburetor air cleaners not adequate."—Arizona banker.

"Screen over headlights makes them inconvenient to clean. Too much engine noise."—New York executive.

"General Motors had no right to deliver cars before their dealers were familiarized with construction of the Corvette. If anything goes wrong they guess and experiment."—California production manager.

"With top and windows up, windshield steams up rapidly even with vent panes partially open."—California real-estate manager.

"Bucket seat good for driver, but should have another bucket seat large enough for two additional passengers."—Idaho lumberman.

How Satisfactory Is Plastic Body?

All but 3 percent of the owners liked the plastic body and 78 percent said they would like to have plastic used on their family cars. There were many owners, however, who had trouble with the plastic body—31 percent of them, in fact.

Here are the comments of a few of those
(Continued to page 356)

Windows, complete with no-draft vents, are stored in trunk. This is the way you have to put them up



POPULAR MECHANICS



General Electric Company photo

Exhaust Flames From Rocket Motor Scatter "Diamond" Trail

You may believe you are seeing diamonds flying through the sky, General Electric scientists report, when you get your first good look at rocket flames flashing by. Photographs of rocket-motor tests show a long string of gem patterns inside each roaring rocket flame, with the fiery ornaments moving into and away from the rocket exhaust as the pressures change inside the motor. As many as eight or nine

of the diamond shapes show up in a single flame. The patterns result, they explain, when shock waves are produced as the hot gases collide with the atmosphere. The long string of diamonds forms as the gases alternately overexpand, then overcontract, as they try to reach equilibrium with the surrounding atmosphere. Once the gases are cooled and slowed sufficiently, the diamonds trail off and disappear.

Five-Ton "Rhino" Floats or Crawls

It may frighten small children, but a steel monster called the "Rhino" is believed by its inventor to be as practical as it is weird. The five-ton vehicle has four hemispherical wheels which float it in water and enable it to cross streams, swamps, mud, desert, mountain passes and roads of any sort. A 110-horsepower engine propels it along the highway at 45 miles per hour. In deep water, it is propelled and steered by a water-jet unit. The machine is designed to combine the advantages of wheeled and endless-track vehicles. On firm ground, it travels on a 4½-inch tread. When the wheels sink into soft terrain, more wheel area is automatically afforded. The 1500-pound front wheels are tilted inward to lower the center of gravity.





Leaf-Raking Machine Built From Scrap Parts

Forty acres of lawn a day are cleared of leaves by a power rake built from scrap parts. Pulled behind a tractor and powered by a motor taken from a broken power mower, it brushes the leaves onto a canvas conveyor that dumps them into a huge bag at the rear. Richard Bourdage, hobby-shop director at the Moose-sponsored Child City, Mooseheart, Ill., built the framework from scrap tin and angle steel. Then he ripped apart his camping tent to get the canvas for the conveyor belt and leaf bag. Scooter wheels and scrap wood furnished the other scrap parts. The only new items in the machine are two cylindrical leaf



brushes connected end to end—Bourdage couldn't find a single commercial brush long enough to fit his homemade outfit.

Landing Net With Scale Built Into Handle Weighs Large or Small Fish



You can weigh fish with a landing net that has a scale built into its handle. The scale weighs up to 30 pounds and can be locked out when it isn't needed. The handle of the net is suspended vertically during weighing.

Find New Way to Make Ice

Refrigerators without compressors, moving parts or chemical refrigerants may result from a recent British discovery. Electricity is passed through a copper junction between a piece of bismuth and a piece of bismuth telluride to create a temperature drop of 50 degrees Fahrenheit. Reversing the flow of electricity results in appreciable heat. The principle behind the system has long been known, but with most metals the temperature change is slight.

Power Cart Rolls to Job

YOU CAN TOTE POWER wherever you want it with a new generating unit mounted on a small cart. The little power plant is no more difficult to move than a child's wagon.

At the job, you can use the power unit as a generator, a pump or an air compressor. With it you can operate electric and air tools, pump out excavations, irrigate gardens, grease farm machinery, spray orchards, livestock and weeds, and perform any number of jobs requiring air, water or electric power.

The portable plant is available in two sizes, one developing six horsepower and the other 2½ horsepower. The basic unit is an air-cooled gasoline engine mounted permanently on the cart. Also on the cart is a mounting which will take the generator, air compressor or water pump. The units are easily interchanged by slipping them in or out of the pin-type mounting. Another item of equipment is an air tank mounted on its own caster wheel. A projection on the tank slips into a socket on the bottom of the cart so the tank can be made a part of the assembled unit. With the air compressor in place, an air hose is run to the tank and the tank filled with compressed air up to a pressure of 150 pounds. This air can be drawn off to operate air tools or spray guns.

All the necessary parts are provided, including the gasoline engine, pump, compressor, generator, air tank and necessary water and air hose.

Gasoline engine runs the air compressor to fill the air tank. Compressed air then operates a spray gun



OCTOBER 1954

125



Electricity from the generator drives an electric saw



Pump throws 100 gallons of water per minute. Basic equipment includes only one of pumps shown below



Copyrighted material

WHAT'S NEW FOR Your Home

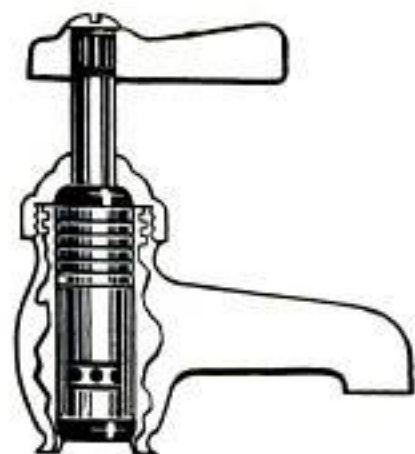
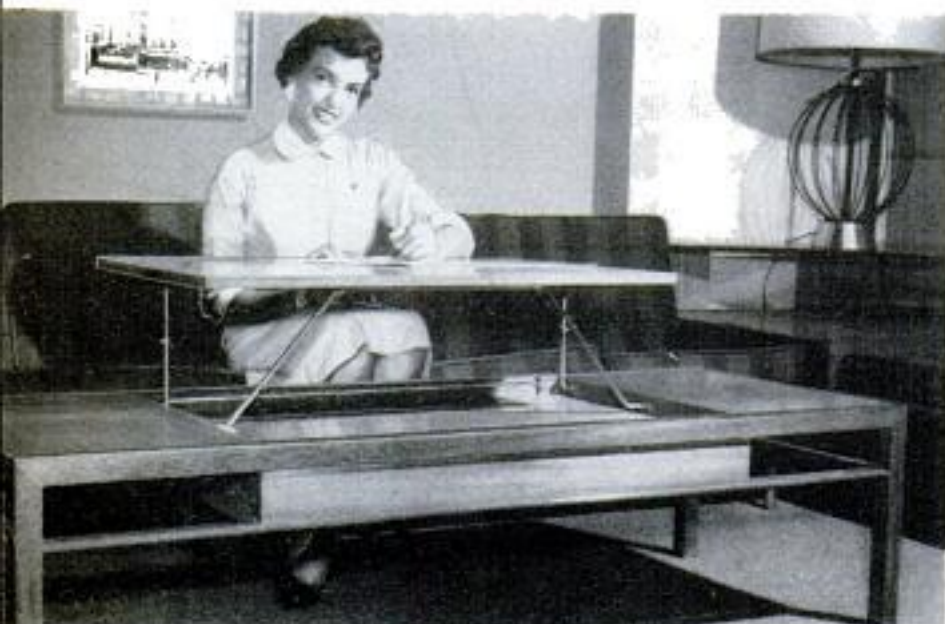

FAUCET UNIT rebuilds old faucets quickly and simply, fits practically any type. Replacement unit seals by a different method than compression type, offers finger-tip flow control

COFFEE TABLE converts to a writing desk. A center section is raised to a 29-inch height on brass supports. The mahogany table-desk was recently exhibited in Chicago

HONE sharpens scissors of any type. The self-adjusting sharpener is built into a plastic handle which rests on a counter top. The blades of the scissors are inserted in the hone and squeezed gently as they are pushed back and forth. Hone adjusts to angle of cutting edge



PHONE SEAT folds into wall when not in use. Single leg locks into position and supports the seat firmly. When you stand up, seat automatically folds back into wall. The complete unit contains a stand for the telephone and an additional ledge. It is fully assembled, is constructed of gummed plywood



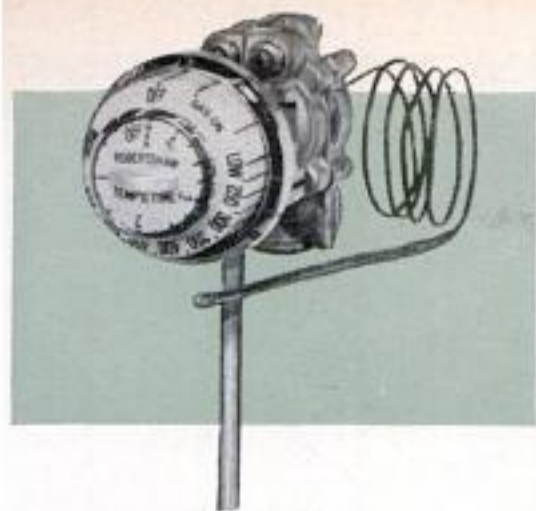

TIMERS for gas ranges shut off individual top burners or oven. Units are self-contained and operate with a clockwork mechanism. Burner timer has one-minute settings up to one hour. Oven timer can be set for four hours



MOISTURE CONDITIONER takes moisture out of the air or puts it in, depending upon the humidity. It is capable of removing up to three gallons of water from the air every 24 hours, or putting two gallons into it in a similar period



GAS FURNACE dries clothes in addition to heating the home. Space-saving drier unit is at convenient height, handles 29 pounds of wet wash in 29 minutes



DISAPPEARING SHELF slides under the kitchen counter when not in use as breakfast table or work surface. No legs are needed. Hinged door hides unit



Copyright



With the car going 20 m.p.h., Mattar removes the flat tire and puts on spare. Note running board to trunk

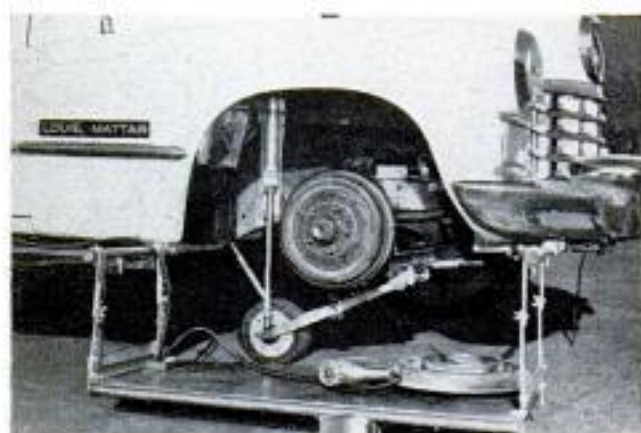

Car rolls on auxiliary wheel during changing. Platform can be hooked to any corner of body

Flats Changed on the Fly

LOUIE MATTAR of San Diego, Calif., doesn't stop to change a flat—he changes it on the fly. Mattar made the tire-changing rig for his proposed 9000-mile nonstop drive from Alaska to Mexico City.

A hydraulic lift raises the wheel as the car rolls along on a small auxiliary wheel. Crouching on a platform beside the wheel, Mattar makes the change. Running boards enable him to get into the trunk to take out the spare tire. He refuels from a trailer he hauls behind the car.

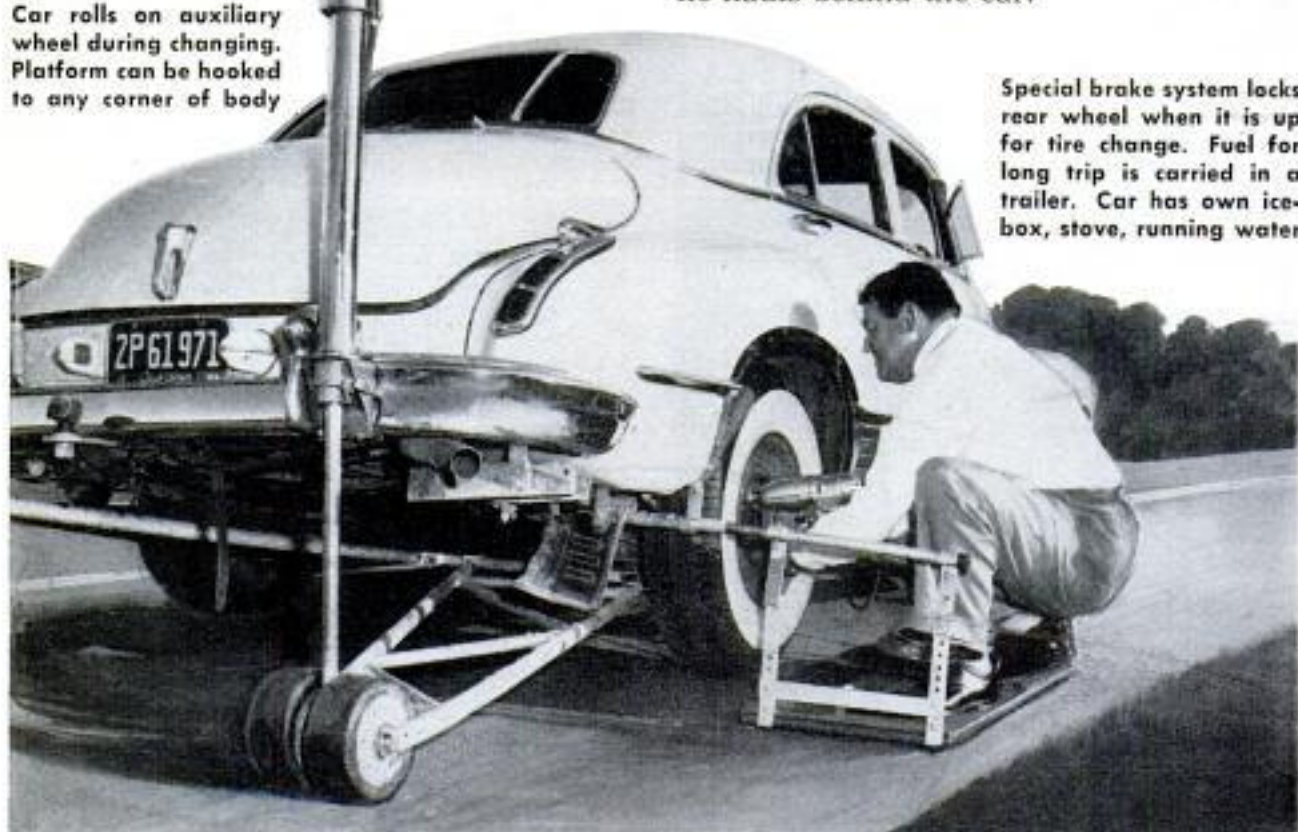

Special brake system locks rear wheel when it is up for tire change. Fuel for long trip is carried in a trailer. Car has own ice-box, stove, running water



Scroll Books Turn "Pages" For Handicapped Persons

Books in scroll form are available to iron-lung patients and other handicapped persons who need only press a finger switch to bring the next page to a comfortable viewing position. An electric motor unwinds the scroll from a lower to an upper magazine when the switch is pressed.

Headrest for Mechanic's Creeper

Mechanics are provided with a raised headrest in a new creeper. The rest can be fixed in any of six positions, is easy to adjust and cannot get out of order. When fully raised, the support extends 7½ inches above the creeper bed.



Moving Surface for Ironing Board

Dutch housewife Mrs. D. Kuys-De Wit has figured out a way to press clothes without lifting her iron. She's constructed an ironing board with a moving surface. The garment is pinned to the board and a set of wheels enables the piece of cloth to be rolled under the iron.

Miniature V8 Motor

Two years of spare time and \$125 went into the building of a miniature V8 motor by Norman Seymour of Whittier, Calif. The five-cubic-inch motor reaches 7000 revolutions per minute, has a 15/16-inch bore and a 7/8-inch stroke. It weighs 13½ pounds. Seymour made most of the parts.



Don't Get Lost in the Wilderness

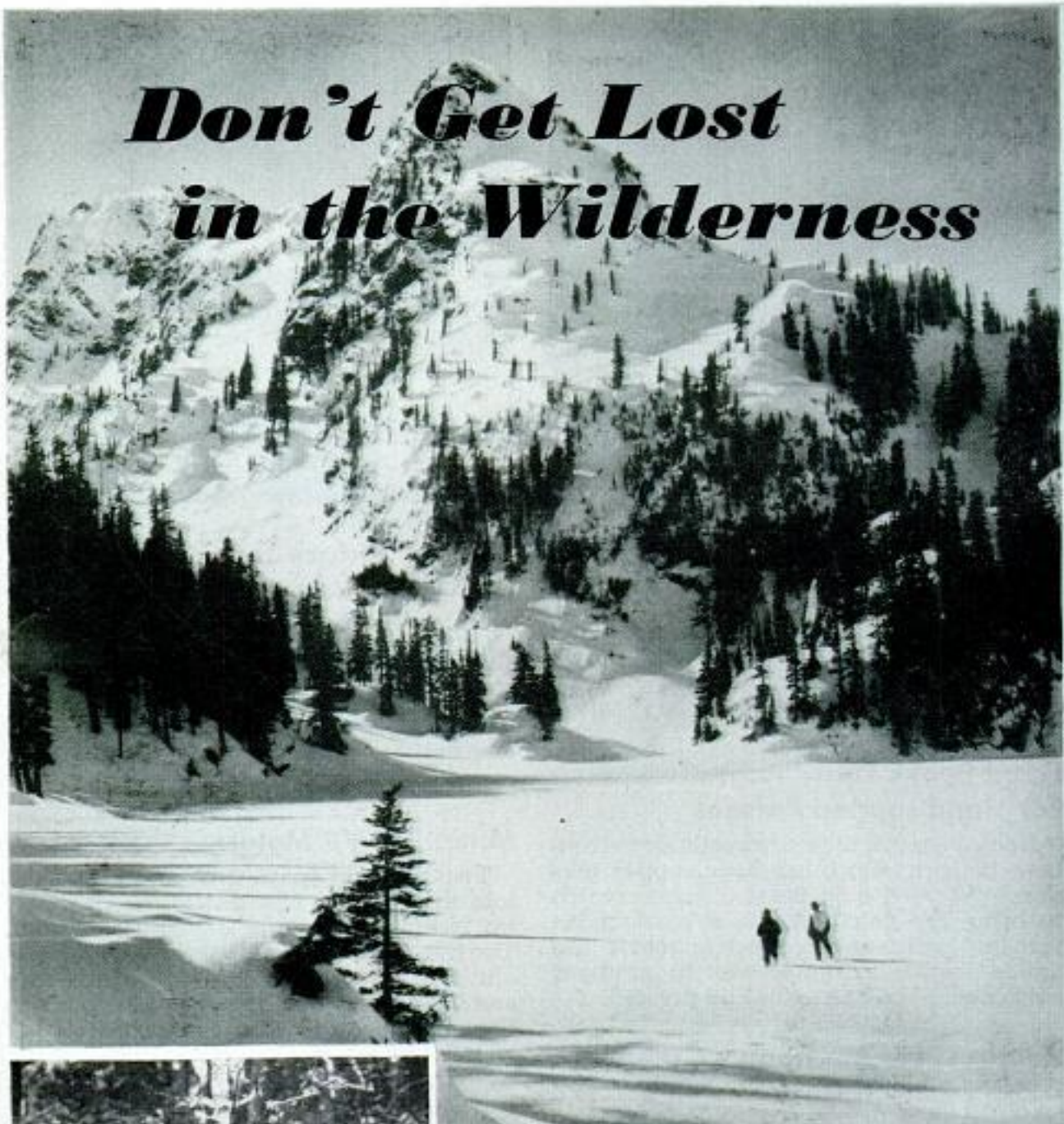

Familiar landmark in summer, a lake loses identity as a snow field in winter. Left, break branches to mark your way back

By George W. Martin

I'M LOST! The thought brings sweat to the forehead and knots to the stomach. Reason often vanishes. Hysteria takes over. Don't let it happen to you.

Even experts can get lost in the woods. The true expert remembers that his biggest worry is not weather, not food or water, not anything but himself. He knows he must not lose control of his senses. To do so may be fatal.

One camper failed to return to camp. At first his friends were not worried because he was an experienced hunter. But by 10 o'clock the next morning they were concerned and sent out a search party. Twenty-four hours later, the man was found wandering aimlessly in the woods no

more than two miles from camp. He had thrown away his gun and jacket the first afternoon when he realized he was lost because they slowed him down. He had frantically "bulldozed" through the thickest brush. His clothes were torn. Deep scratches covered his body. His cap was gone and his hair was matted with twigs. He did not remember resting or drinking at the many streams he had crossed during his 36 hours of hysteria. Consumed with fear, he was sure he would never find his way out. Yet he had been traveling in circles only a mile or two from camp.

Some teen-agers stopped to pick berries in a clearing near the road. When they were ready to leave, a 14-year-old girl was missing. They searched the area, calling her name, but could not find her. Three hours later and ten miles away, she stumbled into a fishermen's camp, hysterical and utterly exhausted. It was unbelievable that a girl with no experience in the woods could have gone so far in such rough country so quickly. Fear had driven her at almost superhuman speed, taxing her strength to its limit. Had she not accidentally wandered into the fishermen's camp, she undoubtedly would have collapsed from exhaustion.

Few of us who have not experienced the sickening fear of being lost have any idea of how we would act in such a situation. One thing, however, that seems common to all is a strange desire to discard all surplus clothing and equipment and hurry, hurry, hurry! There develops a dulling of the senses and a high nervous tension that prevents rational thinking. If you ever go hiking or camping, prepare yourself right now for the possibility of being lost. You don't have to be in a strange area to have



If you get lost, establish a well-marked base camp; then climb hill or small tree to look for landmarks



Mountaineers mark return route with wands—cloth strips tied to sticks. Below, a sudden snowstorm on mountain cuts vision but wands lead party back





Fog rolls in over the peaks. Soon landmarks will be hidden. Campers should be prepared for such conditions

If there are children in the party, it is wise to mark trail plainly by tying cloth to low branches



it happen. A sudden storm, fog, or darkness may blot out recognition of familiar landmarks anywhere you might be.

Three men, in an area they had hunted for several years, made camp by a stream in early afternoon. About an hour before dark, they went up the ridge to look for animal tracks. Twilight began to fall so they started back. After wandering around in the darkness for an hour without finding their camp, they settled for the night in a small opening. They noticed a place where something had been digging by the stream and, being aware that there were bears around, they presumed a bear had done it. All night they half-dozed by a campfire. The next morning they were surprised to see their camp not 100 yards away behind a clump of trees. Their sleeping bags were rolled out ready for use as they had left them. The hole by the creek had been made by one of them the day before to simplify drawing water from the stream.

If you should become lost, there are a few rules that may save your life. Parents should teach these rules to their children as soon as they are able to understand. A most important rule is: If you don't know which way to go, stay where you are so you can be found by your companions.

So that you won't get lost, here are some suggestions to follow:

1. Study maps of the area, noticing directions, rivers, streams and ridges.
2. If possible, discuss the area with someone who has been there.
3. Carry a watch, compass and map.
4. Orient the map by using your compass.



When you are lost, make camp, gather firewood and get reasonably comfortable before darkness closes in

5. If not sure of your location, do not travel at night or in fog unless absolutely necessary.

6. Do not try to go too fast, nor too far to return by daylight.

7. Take time to note characteristics of the area. Look carefully as you go along. Note landmarks by looking back at them—the way you will see them when you return.

8. Take plenty of clothing (preferably some wool), a first-aid kit, flashlight and matches in a waterproof case so you can be

comfortable if delayed.

9. Learn the distress signals. Three successive calls, shots or whistles are standard distress alarms. At least a minute should elapse before repeating them. Use them only in an emergency.

Even taking these precautions, you may become lost. Remember these rules and save your life:

1. Do not lose your head. Sit down and rest. Think over what you will do. Don't

(Continued to page 354)

Magnetic north is near Greenland. Compass points east of true north. Right, watch can be used as a compass

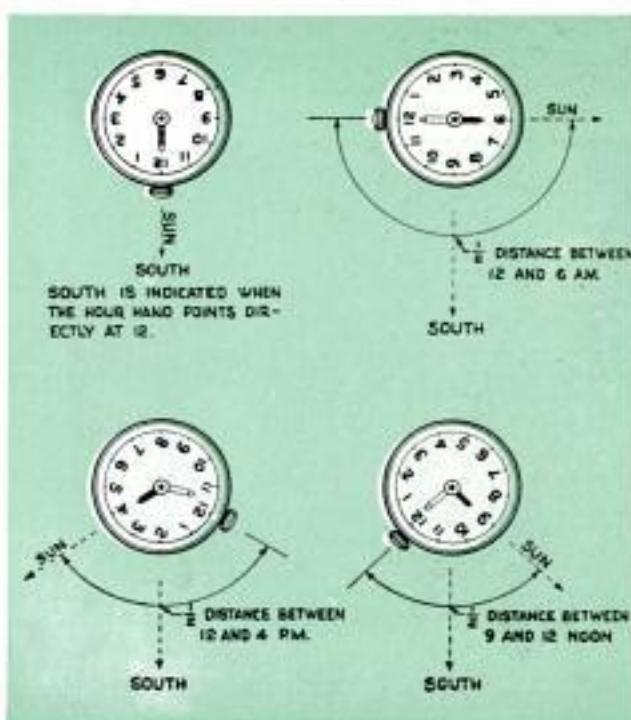
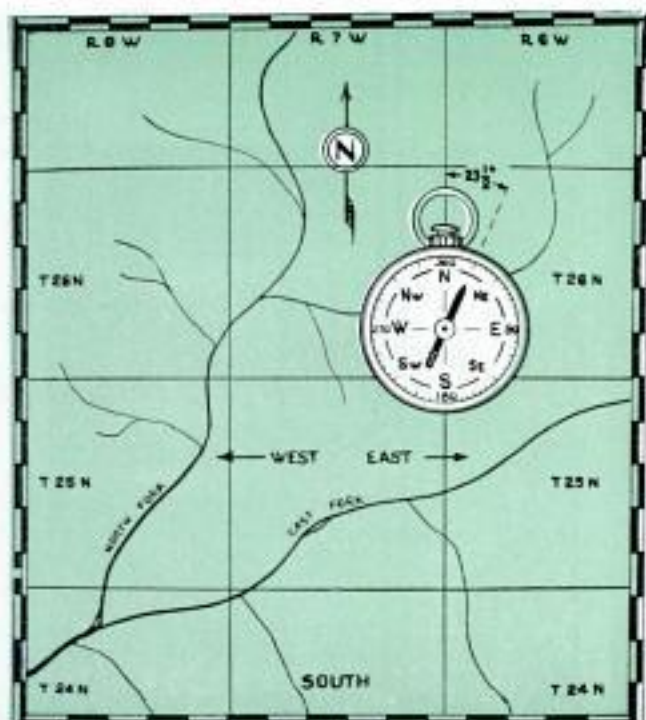

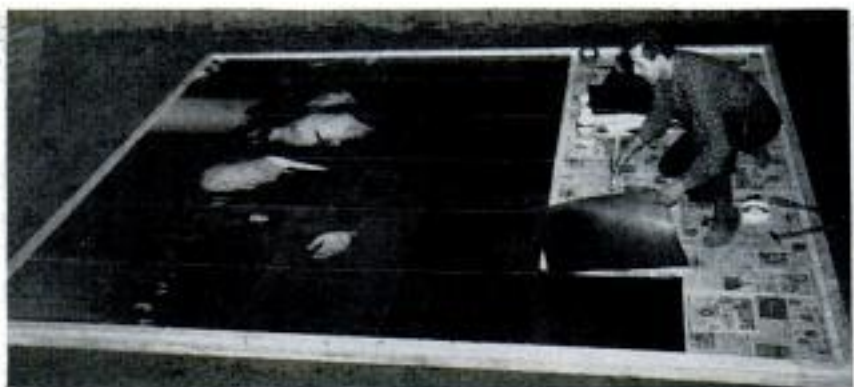

Display "Biggest Photo in Turkey"

Reportedly the largest photograph ever displayed in Turkey was recently exhibited above the entrance of the United States Information Center in Istanbul. The photo shows President Eisenhower with Celal Bayar, president of Turkey. Thirty-six sheets of 24-by-20-inch enlarging paper were used to make the 12-by-11-foot enlargement. Horizontal exposure was made by a 4-by-5-inch negative through an enlarger about 18 feet from the enlarging paper. The image was enlarged about 950 times. Exposure time was 200 seconds.

Coconut Water Introduced Into Bloodstream Replaces Body Fluids

Coconut water may be used in emergencies to replace body fluids, according to a report by Dr. Ben Eiseman of Denver. Preliminary studies carried out in Bangkok, Thailand, and in St. Louis suggest that physicians in remote areas and under emergency military conditions could use

the water from unripe coconuts as a substitute intravenous solution. Twenty-one persons have received a total of 26 intravenous infusions of coconut water without serious reactions. Main ingredients are potassium, chloride, phosphate, sugars, magnesium, calcium and proteins.

Pan American Adds Staterooms for Trans-Atlantic Air Travelers

Luxurious private staterooms are now available on trans-Atlantic flights of Pan American World Airways. They offer privacy to celebrities, businessmen who use travel time for conferences and families flying with children. On the forward

bulkhead of each stateroom is a washstand, a completely stocked toilet-article cabinet and a side stand with a bookshelf. In addition to reclining lounge chairs, it has a private clothes closet and space for storage of overnight baggage.

Pan American World Airways photos



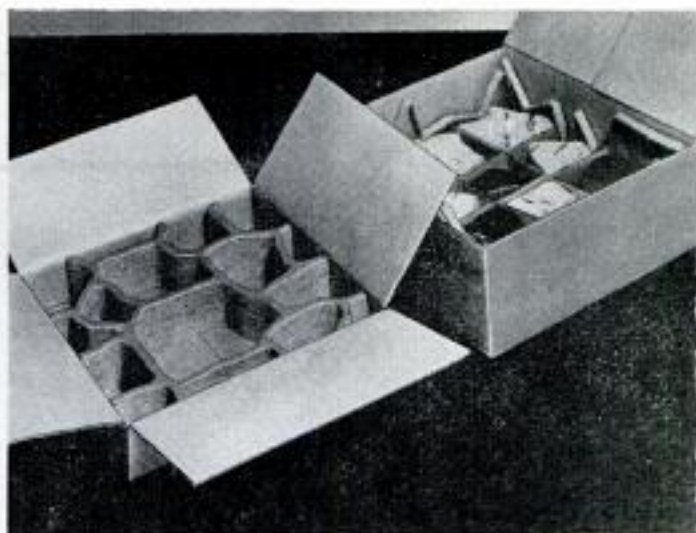
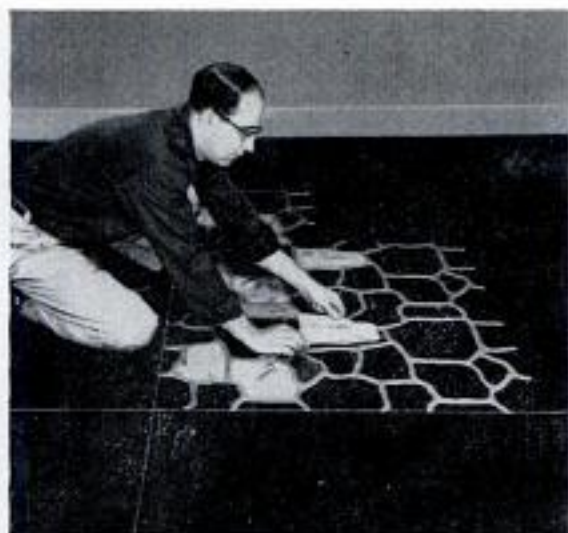

Grids are laid in place, then tiles fitted in. Tiles and grids in single carton will cover 54 square feet

Flagstone-Shaped Asphalt Tiles Fit Between "Mortar" Pattern

Asphalt tiles that look and are shaped like flagstones offer a new way to floor your den or game room. The tiles are fitted into 18-inch-square grids like pieces in a jigsaw puzzle. The grids are cut out of plain gray asphalt tile and resemble mortar. After each row of grids is cemented to the floor, the tiles are fitted into the proper openings; they interlock on all sides of the grids with spaces in the adjoining frameworks. Although more difficult to install than conventional tiles, the simulated flagstones can be laid by the average homeowner. No special tools are needed. One design, combining different sizes of plain, straight grain and swirl-marbleized units, is manufactured in three color schemes. The maker says this is the first asphalt tile made in anything but block shapes.

Completed tile floor lends "outdoor look" to room

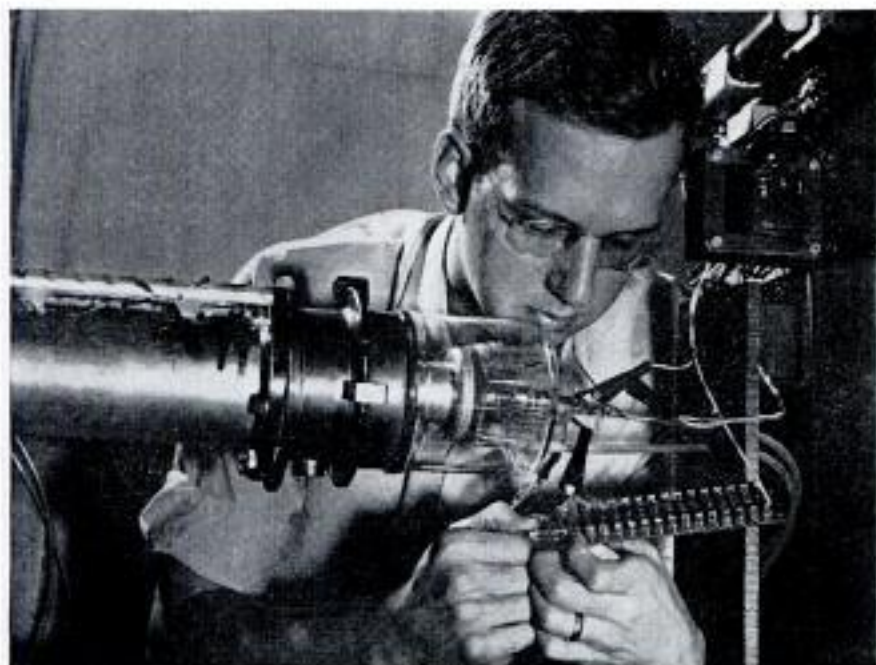

Electron Shooters In "Junior" Sizes

Electron accelerators in "junior" sizes are being developed for cancer therapy and inspection of industrial products. The small accelerators will be patterned after the billion-volt, 200-foot-long linear accelerator at Stanford University. Under development is a 6,000,000-volt, six-foot accelerator for medical treatment. Other sizes will follow. The machines "shoot" electrons in a straight line through a copper tube at almost the speed of light.



Two swamp buggies churn away from the starting line at the beginning of the grind around the mile of mud

THEY CALL IT Swamp Buggy Day, but a better name might be "Carnival of Mud"—for plain, dirty, sticky Everglades gumbo is one of the main ingredients in the one-day celebration held annually at the small town of Naples, on the west coast of Florida.

Founded in 1949, the event is dedicated to the pioneers who traversed some of the soggiest terrain man has ever conquered and settled the Everglades of South Florida.

The special day centers around a strange vehicle called the swamp buggy. Born in the days of the Model T, this souped-up hot rod of the 'Glades now comes in a wide variety of sizes, shapes and power plants. It is essentially a light, high, four-wheeled vehicle with a short chassis, airplane tires, chains and often a four-wheel drive. It's capable of traversing the most difficult terrain.

The swamp buggy was developed as a

Some racers, like the "Betty J," never really get started. A bulldozer is then called in to clear the track





Swamp-Buggy Steeplechase

By Max Hunn



Clean swamp buggies parade before the race begins. Standard equipment on the varied vehicles are airplane tires and chains



means of moving through the trackless and usually sodden Everglades where ordinary vehicles quickly bog down. The machine antedates the swamp-buggy celebration by many years. Ed Frank, an Everglades expert, is generally credited with developing the first swamp buggy at Venus, Fla., from the remains of a sturdy Model-T Ford. Before, travel through the liquid 'Glades was either by ox team, on foot or in boats like the cypress-log dugouts of the Seminole Indians.

Frank built his first swamp buggy for hunting expeditions into the more remote regions of the 'Glades. George Espenlaub, one of his brothers-in-law, helped with the first buggy.

The 1926 runabout was a far cry from the souped-up vehicles which now are virtually standard equipment for hunting parties in the 'Glades. Frank's first Model-T buggy was equipped with truck tires and cleated chains. It was an advance in 'Glades transportation, but not perfect. As the early experimenters said, "We were stuck most of the time, and spent as much

time pushing ourselves out of mudholes as we did driving."

But the idea had merit and improvements were soon forthcoming. George Espenlaub, finding the cleats were doing little good, took casings of larger tires and slipped them over the regular Model-T tires. He then cut sections out of the outside casings and thus had a lug-type tire similar to those found today on modern tractors. It was a definite improvement in traction.

The power plant proved to be the next problem. The Model T didn't have the power to churn through the suctionlike cypress swamps and the sodden Everglades, so the inventors sought a more powerful engine. They adapted a Model-A Ford engine to their purposes and found the power they needed. Many of the swamp buggies today are still driven by souped-up Model-A engines.

As the years passed, more and more changes were made in the basic swamp-buggy design. The chassis were shortened and the bodies stripped of all unnecessary



"Redbug," a revamped tractor, is geared for more speed but retains original power. Its tires need no chains

materials to achieve maximum lightness. Special transmissions were installed, and winches were mounted to enable the buggy to pull itself out with the aid of a tree if mired. Then, shortly before the end of World War II, B-26 bomber tires were substituted for the truck and tractor tires which had become standard equipment. The tremendous surface of the airplane tires made it possible to cross soft mud flats which previously had meant trouble, hard work and possibly complete bogging.

Almost simultaneous with the adoption of the airplane-bomber tires as standard

equipment, four-wheel-drive transmissions—many from surplus army vehicles—were installed, further increasing the traction power of the buggies.

Today, virtually every swamp buggy worthy of the name boasts of airplane tires on all four wheels, a souped-up power plant and usually chains. Short of tackling deep rivers, the buggies will get you there and bring you back—a boon to the hunters who like to prowl the 'Glades.

Stuart Rabb, former newspaper editor in Naples, is generally credited with suggesting the idea of the Swamp Buggy Day.

Man on rear of swamp buggy aids traction by shifting his weight around. Spinning tires send mud flying





Like the "Betty J," this buggy mired at the start of the race. A bulldozer ready for such duty pulls it out

He made the suggestion of a race between buggies while taking pictures of Ed Frank departing on his buggy for a hunting trip.

Today, the highlight of Swamp Buggy Day is a race over a mile track that would make the veteran race driver shiver. There's water and there's mud, and there's more mud. The site is the same as it was for the original race—a cypress swamp near Naples. Of course, the sponsors aren't satisfied with what nature has provided in the way of soggy terrain, and add a few delicate touches—bulldozer style—before race day to make certain that the track is sufficiently gooey. Obliging enough they also provide bulldozers to haul out the many buggies that bog down.

The race is run—if that term can be correctly applied to slipping, sliding, wheel-spinning through the mud—over an oval course a mile in length. Four buggies usually go to the post in a heat but, with normal track conditions, it is a rarity to have all four starters get away.

At the sound of the starter's gun, the engines roar, wheels spin and mud flies in all directions, for steering a straight course while churning up the gumbo is no mean feat. Snorting, grunting and chugging, the buggies move along, some gaining speed, others just plodding, but one and all striving not to bog down.

In addition to the natural mud and the manmade mud, the race has an additional

A foot race through the muck is part of the day's events. Even side-line photographers get their share of mud





Mired swamp buggies keep the rescue bulldozer busy. Axles of these racers are submerged in sticky goo



Chains help traction and are widely used on swamp buggies. Putting them on airplane tires is easy task

hazard in the ruling that each driver must stop his buggy at the water hole, turn off the engine, and dismount and run completely around the parked buggy before starting up again and heading for the finish line a short distance away. The overheated engines often refuse to start again, and more than one leading driver has lost the race because his motor balked at a second start. The spectacle of the driver churning his way through the mud and water around his parked buggy provides laughs for the spectators if not for the drivers. Any driver winning a race earns his prize. Both spectators and drivers will testify to that.

Gradually the celebration has been expanded into an all-day affair. Swamp buggies come from all over the state to compete. Now the celebration starts with a parade of swamp buggies, floats and bands down the main street of Naples. ★ ★ ★

Two swamp buggies roar around the final turn and into the home stretch. The annual race is staged in heats





Small Meter Prints Postage And Moistens Envelopes

No larger than a desk telephone, a handy office meter imprints postage on envelopes or on gummed tape for use on parcel-post packages. The meter, which accommodates envelopes of any size or shape, also moistens the flaps for faster sealing. A rotating wheel selects postage. Two dials indicate the amount of postage used and the amount still available.

Dry Ice Aids Missile Study

Supersonic-missile models made from Dry Ice are tested in wind tunnels at the Naval Ordnance Laboratory in Silver Spring, Md. The frozen models evaporate in the same way that a missile would burn as it speeded through the earth's upper atmosphere.

Foot-Long Pedal

Attached in a few minutes, a gasoline-pedal extender is especially helpful for women drivers. The whole foot rests on the elongated pedal. It can be adjusted to various angles easily.



Ambulance Radio Transmitter Turns Traffic Lights to Red

Traffic lights change from green to red as an ambulance fitted with a special radio transmitter nears intersections. The transmitter, mounted on the window beside the driver, sends a beam to a midget receiver mounted on an intersection signal. The receiver cuts into the signal timing and turns all lights red for five seconds, long enough for the ambulance to speed through. The system, developed by North American Aviation, was shown recently in Los Angeles.

Pulverizer for Rotary Mower Ends Need for Raking Leaves

Easily attached to a gasoline rotary mower, a mulcher pulverizes leaves, making it unnecessary to rake, haul and burn them. The ring-shaped attachment, which is made of heavy steel and will last the life of the mower, fits inside the mower. The vacuum-lift action of the mower pulls leaves into the path of the whirling blade and a flange holds leaves inside the steel ring until they are chopped fine enough to be blown out through small perforations. The leaf particles quickly decompose, adding turf-building humus and minerals to the lawn.





Students learn that reaction time permits car to travel many feet before driver can start to apply brakes

DRIVING RANGE FOR BEGINNERS

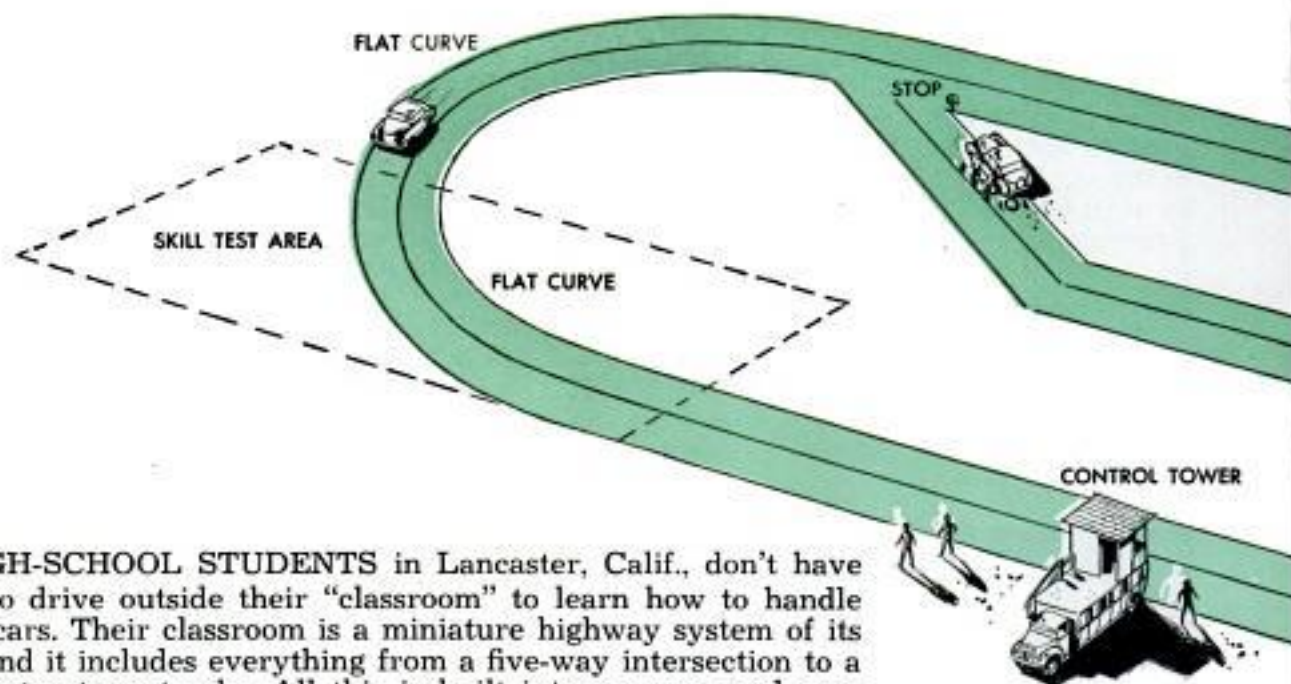

HIGH-SCHOOL STUDENTS in Lancaster, Calif., don't have to drive outside their "classroom" to learn how to handle their cars. Their classroom is a miniature highway system of its own and it includes everything from a five-way intersection to a set of street-car tracks. All this is built into an area no larger than two football fields.

The roads range from a narrow dead-end street, used for testing turn-around ability, to a broad superhighway. There are stop signs galore, a railroad crossing with signals that operate and a variety of curves built into the quarter-mile roadway that completely encircles the area. Inside the oval there are several streets with six different types of intersections. In addition, there is a large paved area for special skill tests, including some portable curbing for parking problems.

Instructors sit in a control tower and communicate with "law breaking" drivers by loudspeaker. Once proficient on the course, the students take final exams on regular city streets. ★ ★ ★



Detonator on front bumper fires chalk on road when signal to stop is given. It fires a second mark when brakes are applied, showing reaction-time travel



Top right, from the control tower the instructors observe the entire test area and give out "traffic tickets" to violators through a loudspeaker system

Girls demonstrate blind spots in the car. None of these girls can be seen by the driver unless he moves his head

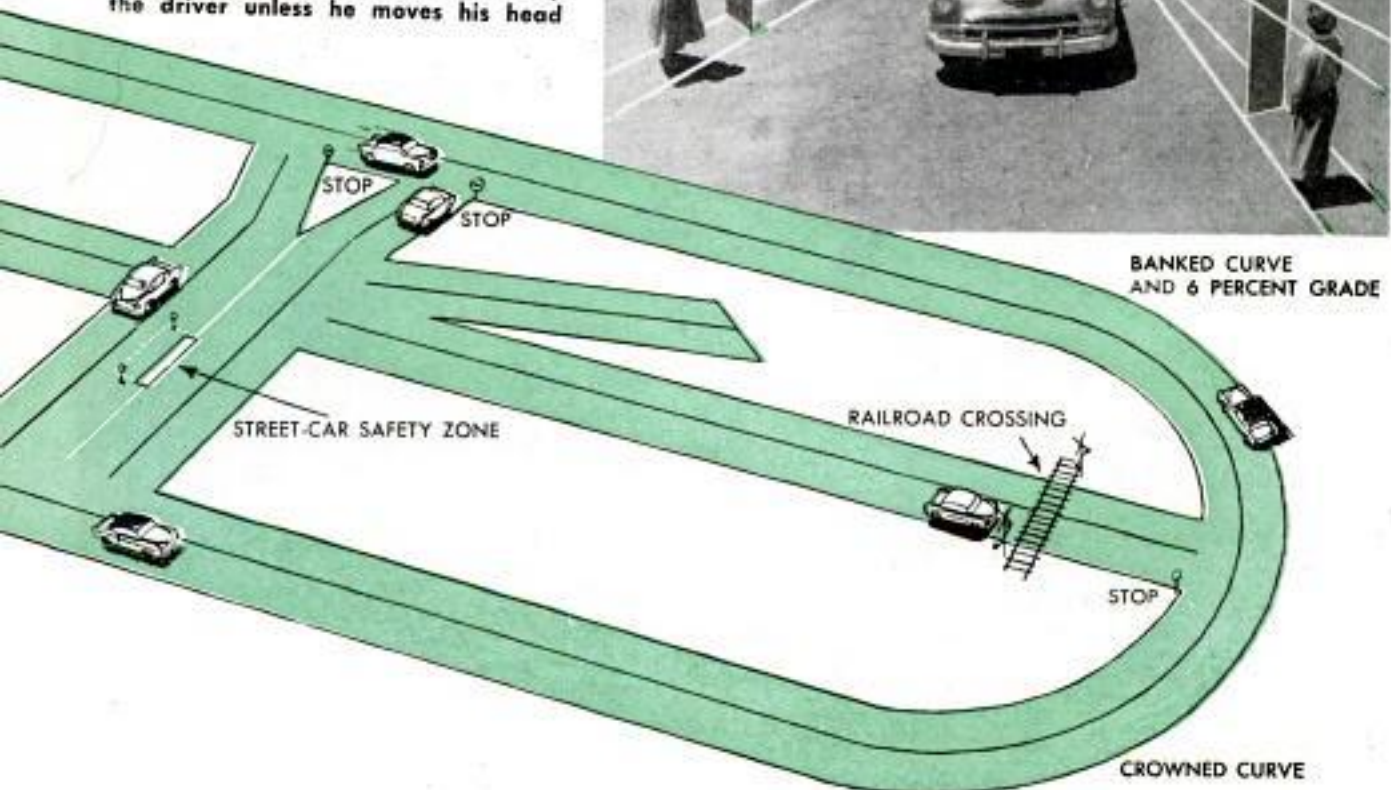
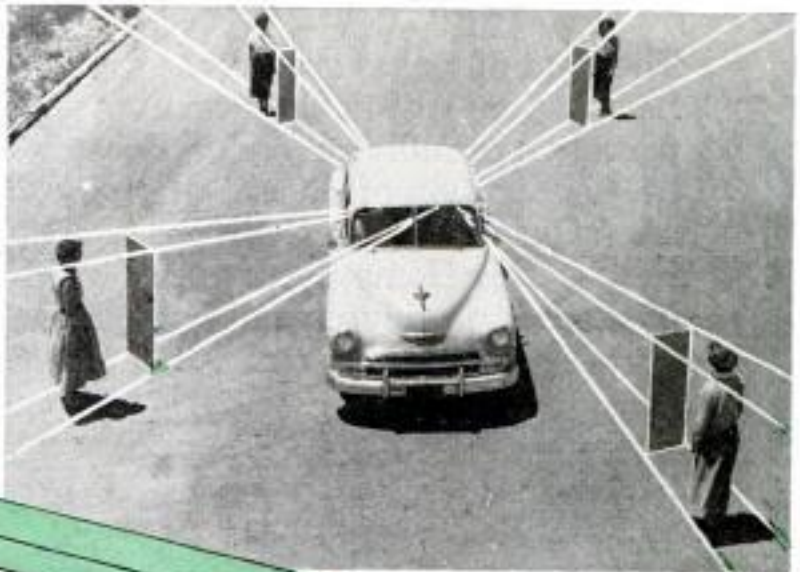

BANKED CURVE AND 6 PERCENT GRADE

CROWNED CURVE

Drawing of the high-school driving range shows how maximum use has been made of the area. Included in the layout are several types of curves, as well as a variety of intersections, stop signs, a railroad cross-

ing and other highway hazards. While the oval may look like a race track, it is not used for that purpose. Skill-test area has room for practicing parking, tire changing and maintenance inspections

Presenting:

POPULAR MECHANICS ANNUAL



HOME SECTION

The next 50 pages are devoted to your home—whether it be new, old or still in the dream stage. In the following color pages we proudly present a house which was designed with the cooperation of several thousand *PM* readers. Our editors and artists have traveled from coast to coast gathering material for this Home Section and we think it is representative of the best in houses and home ideas being produced today.



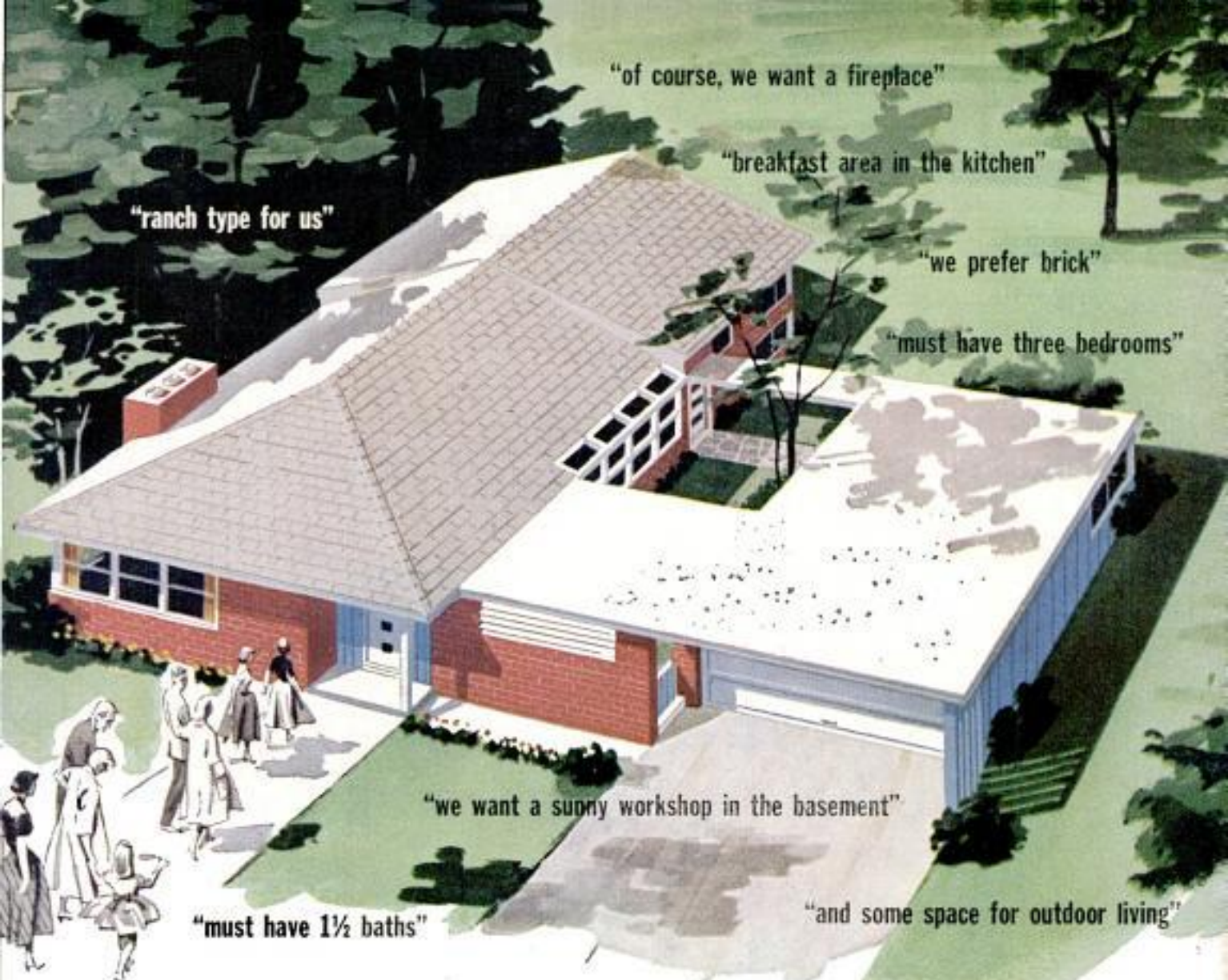

"of course, we want a fireplace"

"breakfast area in the kitchen"

"ranch type for us"

"we prefer brick"

"must have three bedrooms"

"we want a sunny workshop in the basement"

"must have 1½ baths"

"and some space for outdoor living"

"What kind of a home do you want?" we asked 5500 PM readers. From their responses, Rudolph A. Matern, noted architect, has designed

The House You Asked For

By Wayne Whittaker

OUT OF THE DREAMS of our readers came this house. Dreams that were written down on paper, totaled up into neat percentage tables and handed to a noted architect with the commission:

"Translate this dream into a real home. A three-bedroom home, in the medium-price bracket, with space for outdoor living, an ample workshop for the man in the family; a one-story ranch house with a bit of that architectural genius that lifts it out of the ranks of the ordinary."

It began with a questionnaire asking 5500 readers of *Popular Mechanics* in every state and the District of Columbia just what they want in a home. Brick house or frame? Basement or none? Fireplace? Air conditioning? And how much would they spend? This must be no impractical dream

house; the pocketbook must rule the plan.

So enthusiastic was the response that 3561 replies from our subscribers were in our hands within a brief few weeks. Many more came too late to be included in the survey figures.

The figures, expressed in preferences and added up into percentages—78.7 percent wanted a one-story house, 13.7 preferred two stories and 7.6 percent specified the split-level, and so on—were assembled for us by an independent consultant and

Blueprints for this house are available. Write: Plans Department *Popular Mechanics Magazine*, 200 East Ontario Street, Chicago 11, Illinois.

put to the architect in the form of a problem: "Here's what the majority of *Popular Mechanics* readers—let's say the majority of American families—prefer in a new home. Translate these desires for us into a plan for modern living."

The architect chosen was Rudolph A. Matern, A.I.A., of Jamaica, Long Island, N. Y. One of the leading designers of ranch-

type houses in the world, he was frankly fascinated by the assignment. He was not to work out a solution merely for the wants of a single home builder, but satisfy the demands of a vast majority yet with no loss of style and individuality.

Out of the dictates of the readers and

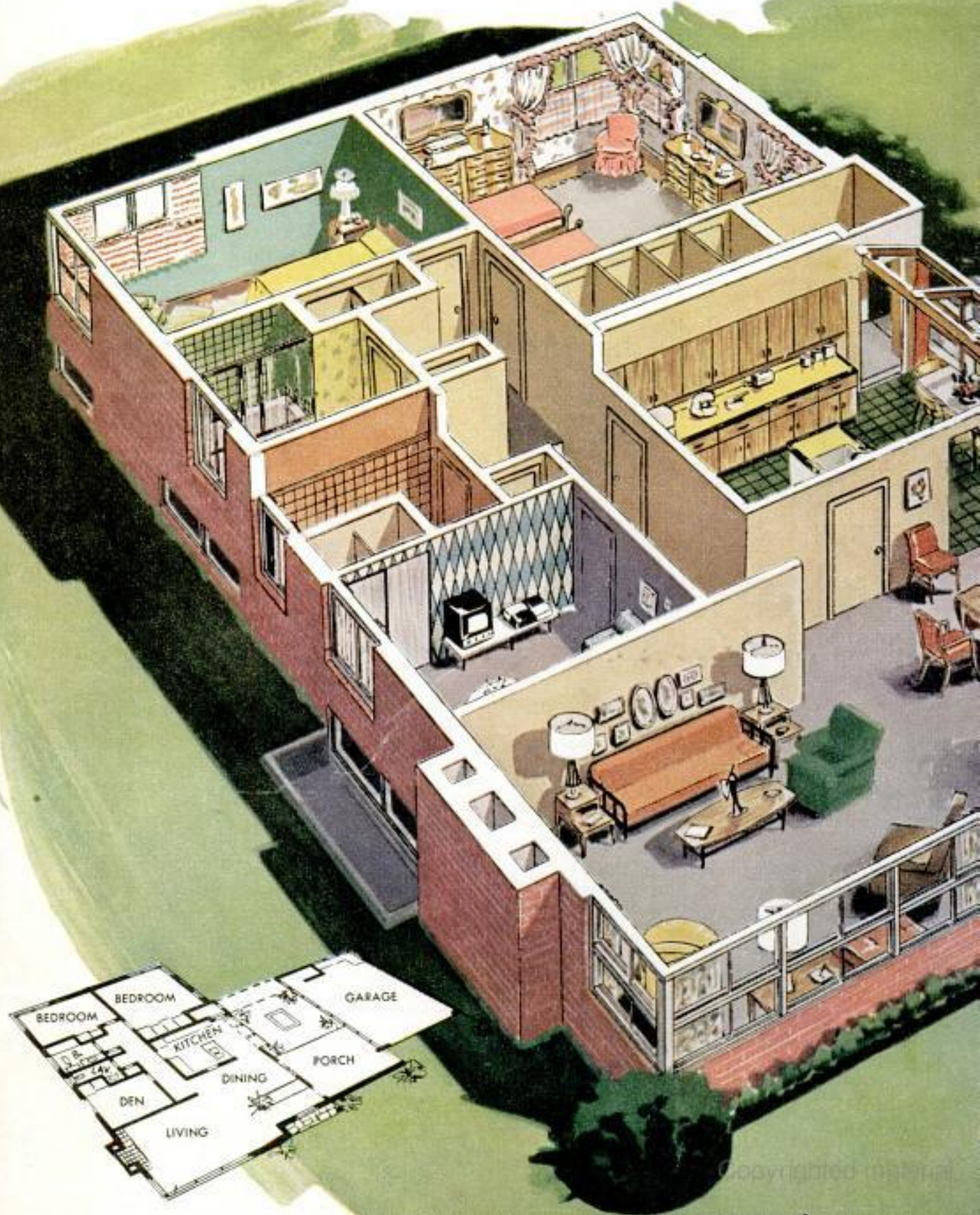

Matern's experience and ingenuity came the Survey Home shown on these pages. It is neither ultramodern nor stuffily tra-

ditional in feeling. Reflecting the desires expressed by a large cross-section of the public, it is truly "the house you asked for."

Cutaway shows room arrangement and outdoor-living area which separates house and garage. Two rear bedrooms and bath are three steps higher than the rest of the house. The third bedroom is shown furnished as den. Below, street-level view of the home

Interior furnishings and color by Marshall Field & Company, Home Planning Bureau, Chicago

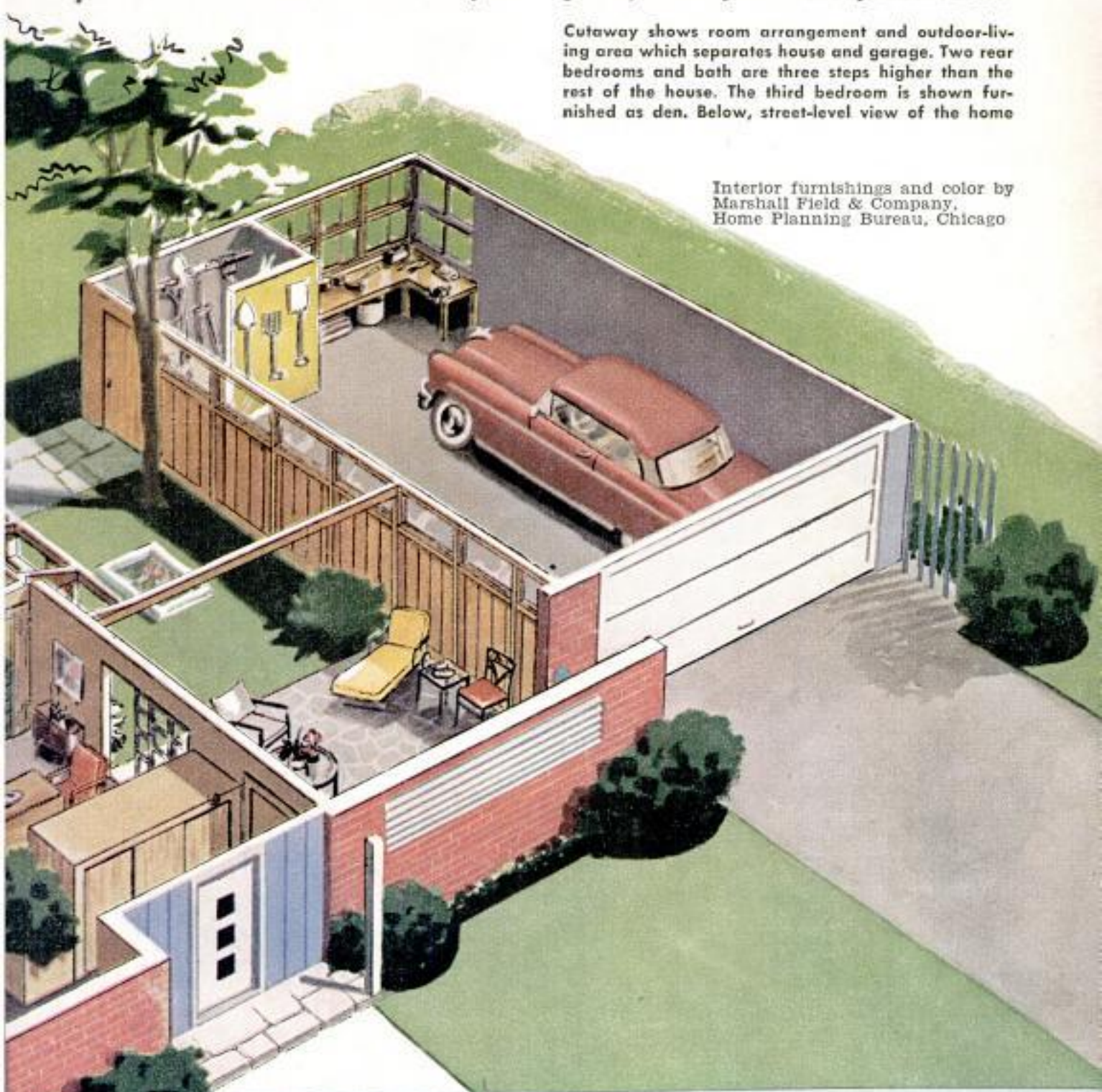

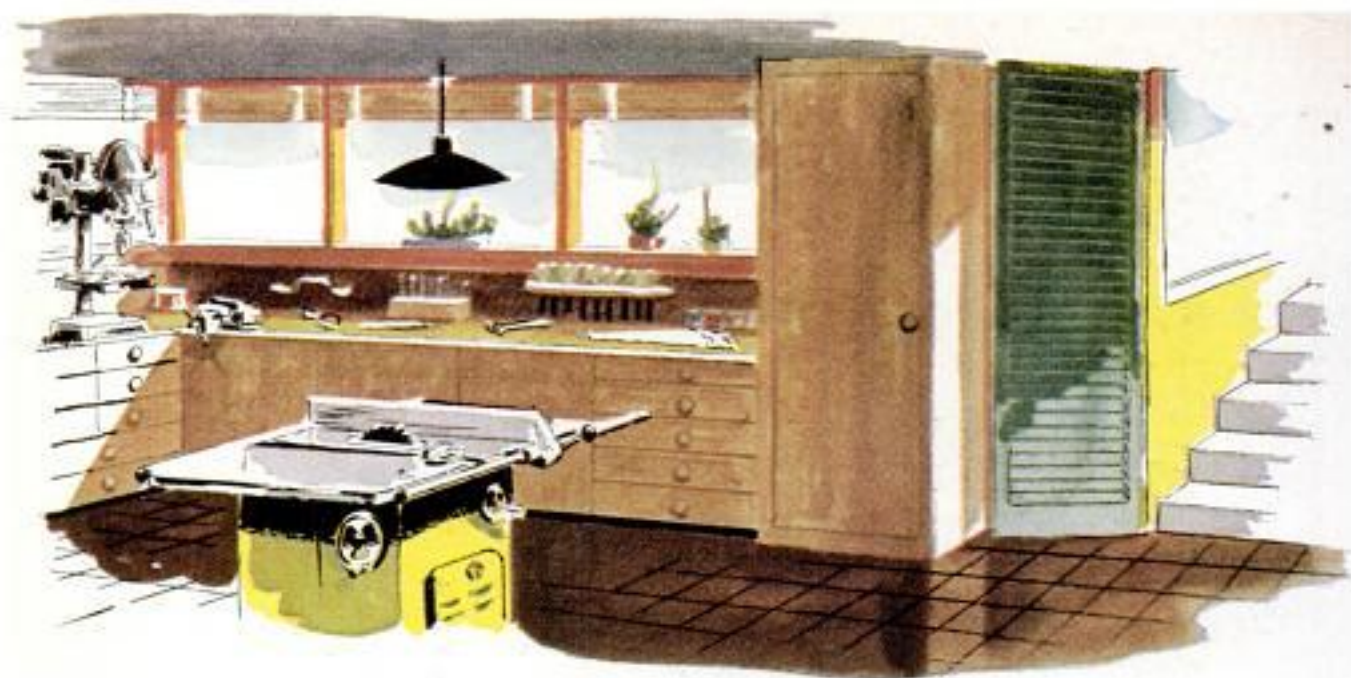

Readers voted for a "sunny basement workshop with outside entrance." Architect Matern raised roof to do it

It will serve the wants of an informal family that loves beauty, comfort and convenience; that depends on its automobile for coming and going; that likes to entertain modestly and live outdoors as much as possible. The description fits the average American family of 1954.

Right from the beginning, the readers in filling out their detailed questionnaires

took matters firmly in their own hands.

"And where's the question about workshop space?" wrote an indignant reader from Decatur, Ala. "Possibly you intended the question about the basement to cover this point."

We had not included a question about workshop space because we took it for granted that any house designed by or for

Breakfast end of kitchen features skylight and window wall looking out on garden patio. Sink is island type



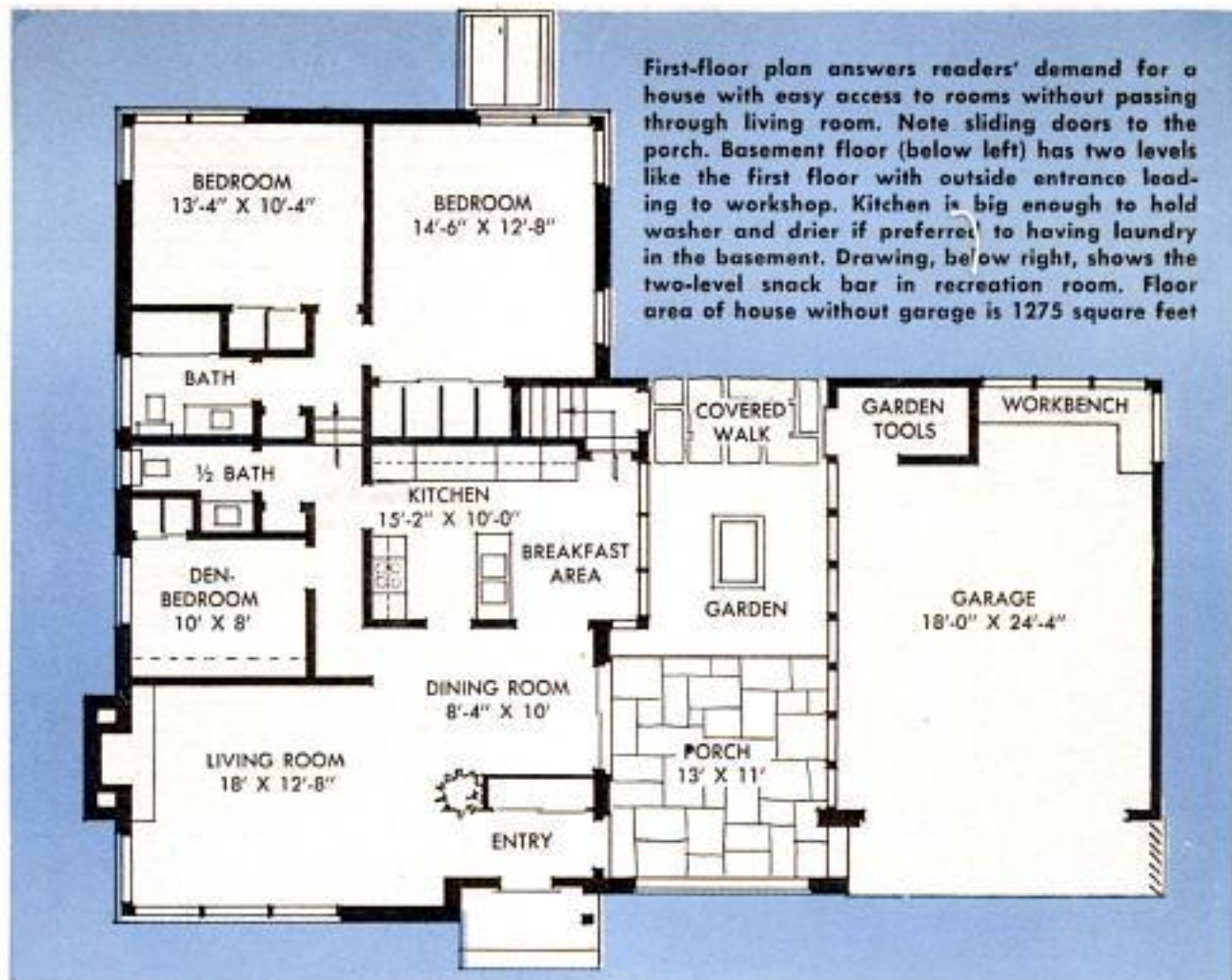

First-floor plan answers readers' demand for a house with easy access to rooms without passing through living room. Note sliding doors to the porch. Basement floor (below left) has two levels like the first floor with outside entrance leading to workshop. Kitchen is big enough to hold washer and drier if preferred to having laundry in the basement. Drawing, below right, shows the two-level snack bar in recreation room. Floor area of house without garage is 1275 square feet

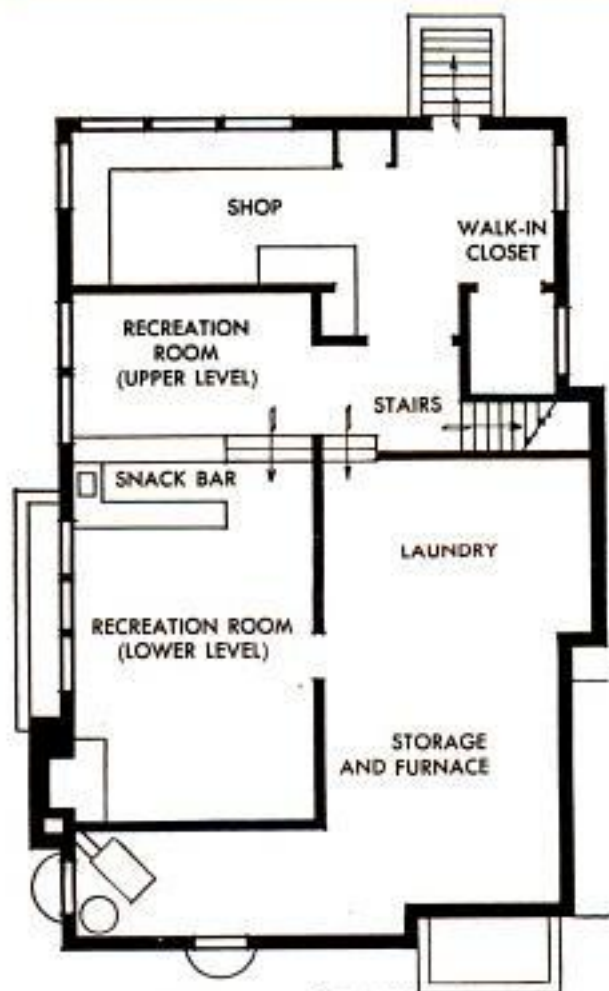

our readers would have such an area. However, it seems that many readers have studied countless house plans—particularly those without basements—which simply do not have adequate space for a workshop.

The great majority of readers (79.5 percent) specified they do want a basement and that they would like their workshop located there. Many requests also



PERCENTAGES FROM HOUSING SURVEY

TYPE OF HOUSE		FIREPLACE FOR AN ADDITIONAL \$500	
Ranch type, one story, low-pitched roof.....	68.3%	Yes	58%
Traditional, Cape Cod, Dutch colonial, etc.....	19.8%	No	42%
Modern, flat or shed-type roof.....	13.2%	OUTDOOR LIVING AREA	
BEDROOMS		Yes	74.2%
Three	60.8%	No	25.8%
Two	27.6%	HEATING AND AIR CONDITIONING	
Four	11%	Furnace	59.3%
One6%	Year-round air conditioning for \$600 extra or more.....	31%
NUMBER OF STORIES		Neither of the above.....	9.7%
One	78.7%	GARAGE	
Two	13.7%	Two-car	66.7%
Split level.....	7.6%	One-car	23.3%
BASEMENT		Carpport	7%
Yes	79.5%	None	3%
No	20.5%	BATHROOMS	
EXTERIOR FINISH		One and a half.....	52%
Brick	48%	One	26.6%
Frame	28.1%	Two	21.4%
Shingles (cedar shake, etc.).....	17.1%	METHOD OF BUILDING	
Concrete block	9.8%	Build completely by yourself.....	16.5%
Others7%	Contract for foundation, plumbing, heating, electrical work, balance by yourself.....	22.7%
<i>(When figures exceed 100% it is because some readers checked two or more answers in the questionnaire.)</i>		Have contractor build shell and finish yourself.....	21.6%
DINING-ROOM ARRANGEMENT		Have professional contractor build the complete home.....	39.2%
Combination living-dining	34.9%	COST OF HOME NOT INCLUDING LOT	
Combination dining-kitchen.....	34.8%	\$7,000	7.1%
Separate dining room.....	31.3%	8,000	7.2%
KITCHEN ARRANGEMENT		9,000	6.2%
With breakfast area.....	68.4%	10,000	18.3%
Without breakfast area.....	11.3%	11,000	3.9%
Adjoining utility room.....	33.2%	12,000	13.3%
LIVING-ROOM ARRANGEMENT		13,000	4.6%
Living room at front of house with windows facing street.....	73.3%	14,000	4.3%
Living room at rear with windows facing yard.....	26.7%	15,000	13%
OPEN-PLAN ARRANGEMENT		16,000	3.1%
Yes	58.8%	17,000	2.2%
No	41.2%	18,000	3.7%
		19,0009%
		20,000	4.9%
		21,000 and over.....	7.3%

came in for an outside entrance to the shop. Some requested additional shop space in the garage, in addition to storage area for lawn mower and garden tools.

Matern's provision for workshop space is one of the outstanding features of the home. He literally raised the roof to do it (see cutaway drawing). This resulted in a higher ceiling for the workshop end of the basement, providing additional window area. Workshop fans will approve the handy outside entrance leading directly into the shop. (It's also convenient for children headed for the recreation room.) In addition, Matern has provided space for a workbench in the garage. If the house were to be built without a basement, this area could be enlarged to a full-size shop. The garage also provides adequate storage space for garden equipment.

The highest percentage in the poll concerned the demand for basements. This, no

doubt, will shock many modern architects who insist that "basements are a thing of the past." A reader from Wyncote, Pa., wrote: "A full basement gives plenty of room for furnace, fuel, water heater, laundry, lines for drying the wash, workbench and power saw. No house should be without one." This sentiment was echoed over and over.

The next highest percentage (78.7) favored a one-story home. In this group, 68.3 percent preferred the ranch-type with a low-pitched roof.

Another high percentage (73.3) requested that the living room be located at the front of the house with windows facing the street. Others logically pointed out that placement of the living-room and big windows would depend on the view (if any) or landscaping possibilities of the rear yard.

(Continued to page 256)

The RIGHT GRADE of LUMBER SAVES MONEY

NOT ALL THE lumber for your new home must be select stock, no more than all parts of your automobile need be tempered steel. Your home's soundness is highly important, but if you demand the best lumber throughout, you do not necessarily get a better house—it just costs you more.

By utilizing inexpensive grades wherever suitable, you can save up to \$1000 on the cost of a three-bedroom home. And if you take a 30-year mortgage, this saving is about doubled because interest, too, is saved. The cutaway drawing shows the proper use of various lumber grades in a modern one-story house. This construction complies with FHA specifications. No. 3 studs, though they have more knots than No. 2, have ample rigidity for the walls. In a two-story house, where the first floor carries the entire weight of the second, No. 2 studs should be used on the first floor and No. 3 on the second. Joists and rafters vary with their spans; No. 3 is ample for short spans, No. 2 or No. 1 for longer spans. For subfloor, walls and roof sheathing, No. 3 boards are quite adequate.

In exterior siding and finish flooring, the imperfections of a B or C grade will vary somewhat with different species, so look before you buy. You can save money in buying most sidings by purchasing shorter lengths. For the popular modern finish of using cedar siding with the rough side exposed and stained, specify a B or C grade; the small knots, waness and skips in planing will not show. Short lengths and a B or C grade mean a good saving in both softwood and hardwood flooring and often make a

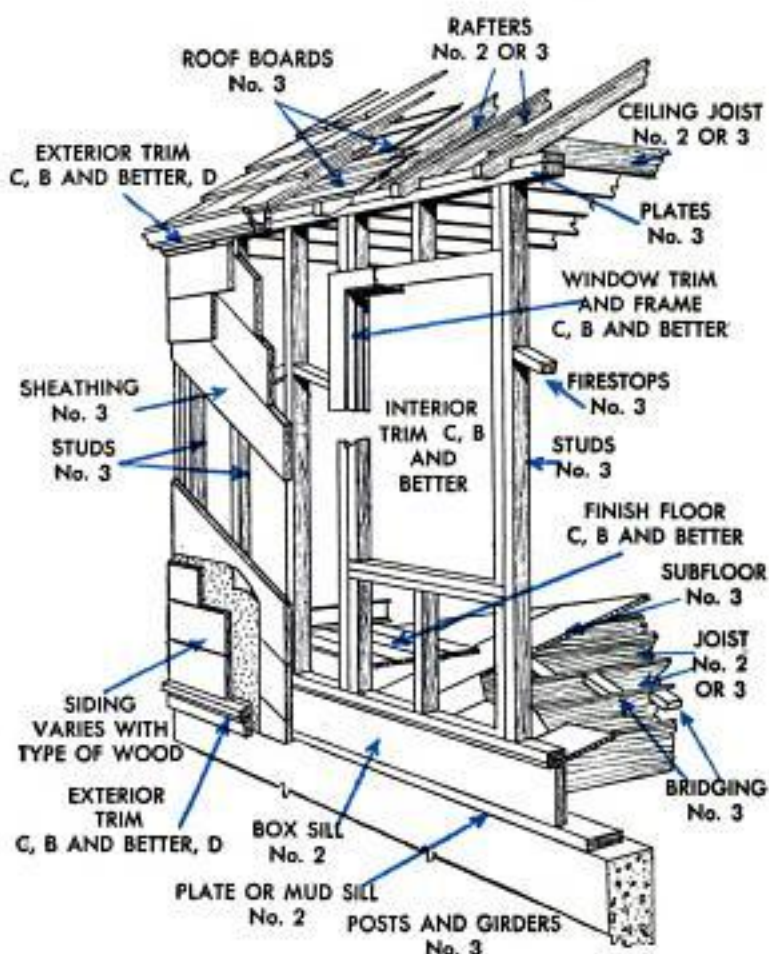

more attractive floor than clear stock.

Many builders save on wood interior paneling by purchasing dry No. 1 common hemlock or pine boards and having a local mill run tongue-and-groove edgings on them, or use a molding to cover the joints. Result—knotty paneling at half price. A modern paneling is obtained economically by using C-grade hardwood or softwood flooring on the walls. For kitchen cabinets you can save without sacrificing quality by purchasing reject or utility-grade plywood and using the sections with imperfections where they won't show.

SAVINGS ON A \$14,000 THREE-BEDROOM HOUSE

MATERIAL	AMOUNT	COST HIGHER GRADE	COST SUITABLE GRADE	SAVINGS
COMMON BOARDS	5,500	No. 2 \$506	No. 3 \$310	\$ 196
COMMON FRAMING LUMBER	10,000	No. 2 \$960	No. 3 (60%) \$372	204
			No. 2 (40%) \$384	255
CEDAR SIDING	3,000	CLEAR \$720	C \$465	83
FINISH FLOORING	1,250	A \$294	B \$211	207
WALL PANELING	1,500	A \$360	No. 1 COM. RERUN \$153	37
PAINTED TRIM	800 FT.	CLEAR \$ 95	C \$ 58	70
CABINET PLYWOOD	1000 SQ. FT.	A-B \$265	UTILITY \$195	\$1,052



Iron Fireman Mfg. Co.

Compact vertical-type furnace may be placed in an inconspicuous corner of the basement or in a closet in utility room or kitchen



National Warm Air Heating and Air Conditioning Association

New space-saving designs in forced warm-air heating units make it possible to stow furnace in attic (above) or crawl space (below)

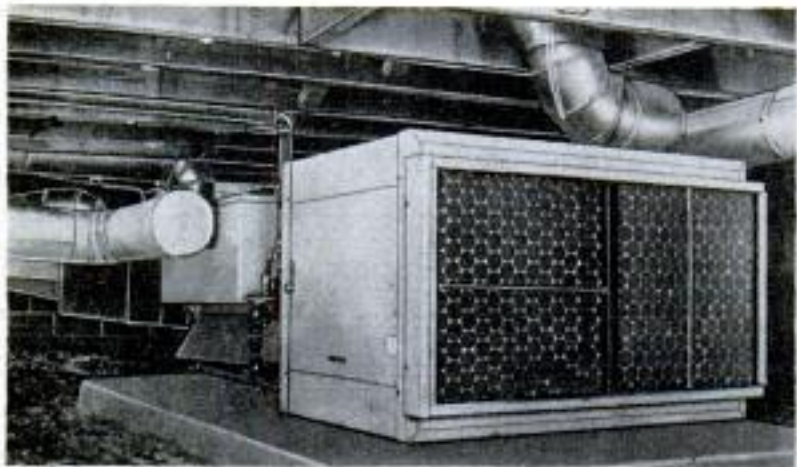

Space Savers for Heating or Cooling

NOT TOO MANY YEARS ago it was taken for granted that the furnace would be found in the basement, that it would be a metal monster and would have an octopus system of huge pipes. In the modern or reconditioned home of today, a new space-saving heating and cooling plant may not only be inconspicuous but actually hard to find.

The words "furnace" or "heating plant" are frowned upon by engineers who rightly prefer "winter air-conditioning system." And why not? The air in many forced-air systems is filtered before being heated and circulated. Also, the same fans and ducts may be incorporated in the conversion to summer air conditioning.

The modern furnace may be found in a number of out-of-the-way places including a kitchen or utility-room closet, attached garage, attic, crawl space beneath the floor, and the basement. Trim and efficient, the compact units would never be recognized for what they are by the householder of 20 years ago.

The space-saving types of heaters include the vertical



National Warm Air Heating and Air Conditioning Association

There are no cumbersome overhead pipes in this recreation room equipped with vertical reverse-flow furnace

furnace, the horizontal, the reverse flow and the floor furnace. Additional space is required for cooling units—but not much. The vertical furnaces are tall and narrow and are designed to fit in a closet or any small built-in compartment. Many of these occupy a third or less of the floor space required by an ordinary furnace. The horizontal furnace, particularly adaptable for perimeter heating, is ideal in crawl space or attic as well as in the basement. Despite the size, this unit comes equipped with efficient firing unit and heat exchanger, air filters, humidifier and air-circulating fan. The vertical reverse-flow furnace discharges the warm air at the bottom of the unit. A new floor furnace is of the reverse-flow type. ★ ★ ★



Airtemp Division, Chrysler Corporation

A small corner of the utility room accommodates a furnace which serves a perimeter system. Return air circulates through filter in top, eliminating grilles

This room air conditioner for casement windows has grille sections held by springs for changing direction of air. Below, year-around heating and cooling

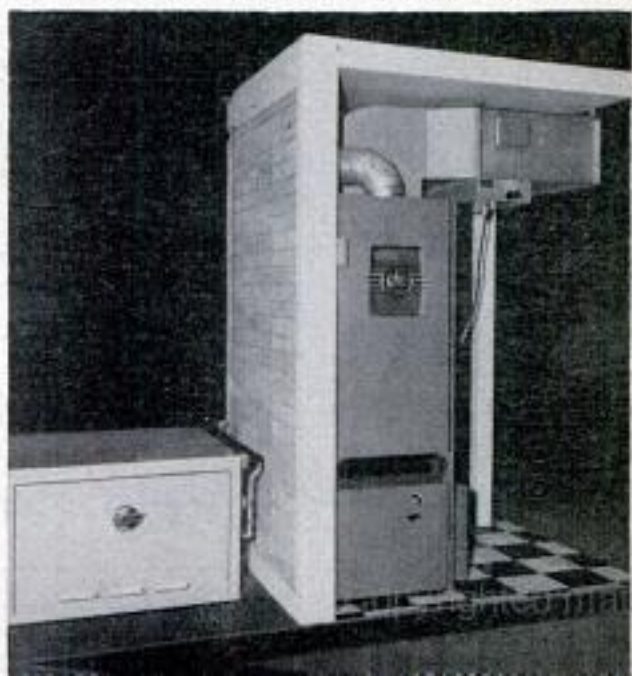

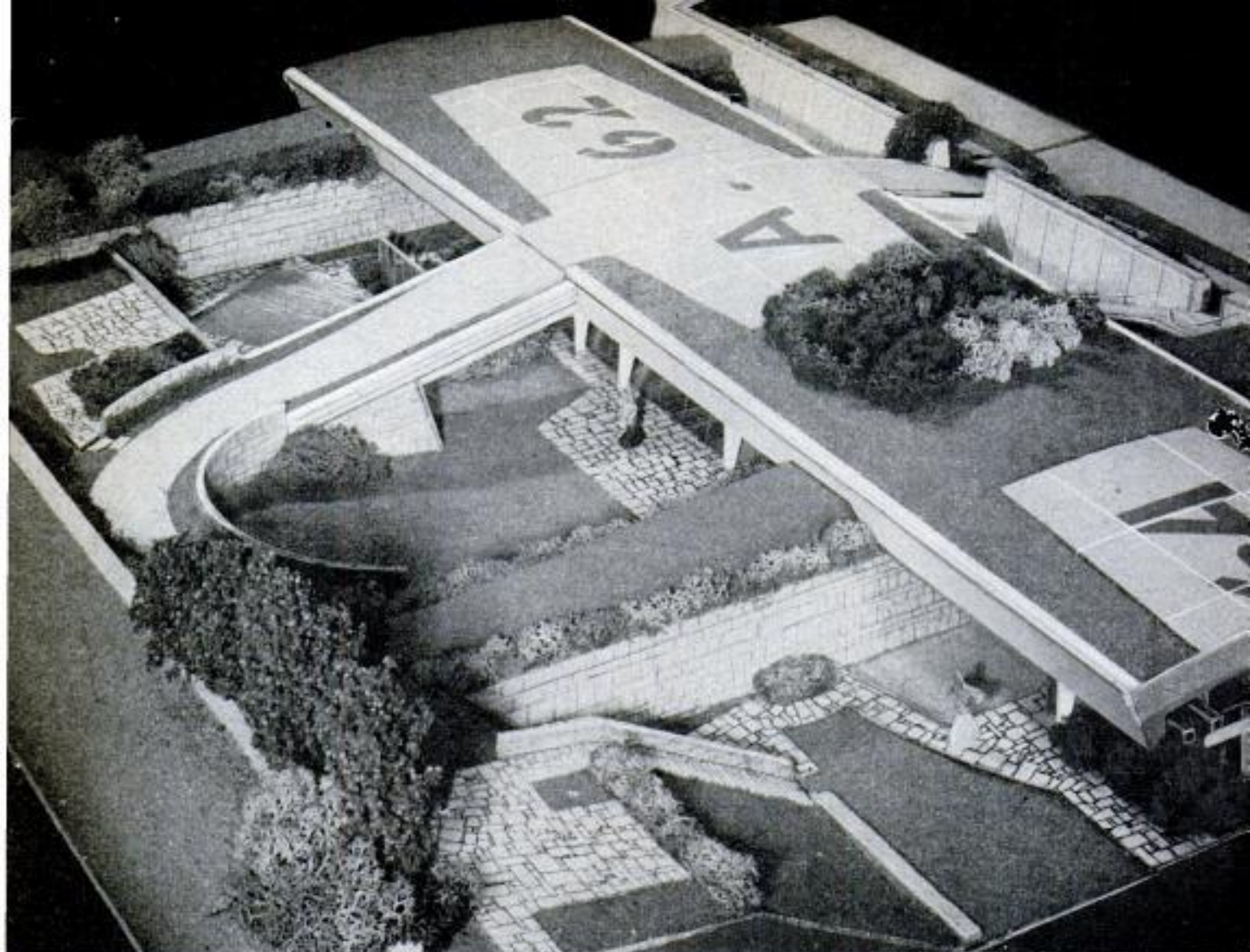

You'll land your copter on the roof, keep it in the flyport and live underground, according to Laszlo

AT HOME, 2004 A.D.

By Carson Kerr

SUPPOSE it's a sunny Saturday in 2004 A.D. and you're on your way to visit the Smiths in Atomville, one of America's new—completely new—communities. A supersonic airliner is taking you there and, in an almost unbelievably short time, it

approaches the Atomville airport. This city of the twenty-first century is laid out along strict radial lines, its streets running in concentric rings from the center and its homes all look-alikes. From the air, the residential areas resemble huge land-

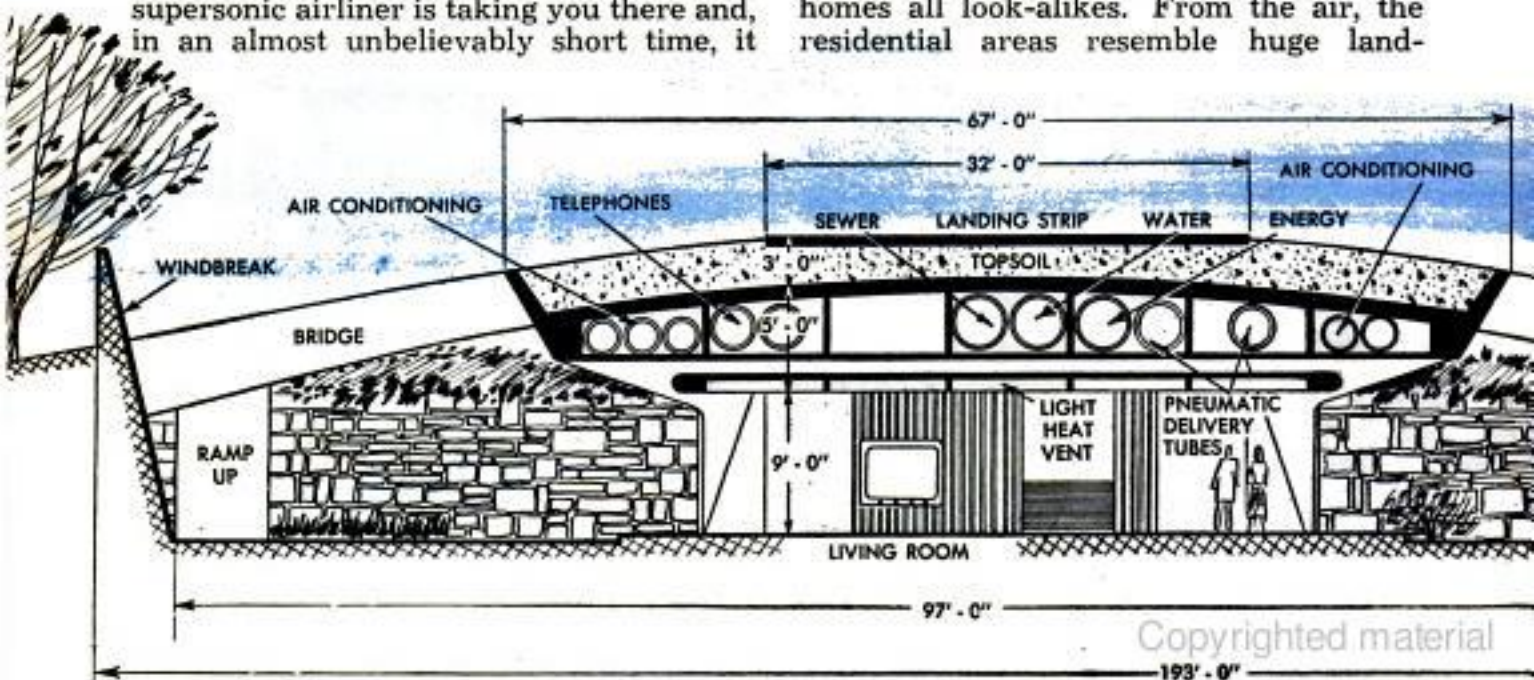

Copyrighted material
193'-0"

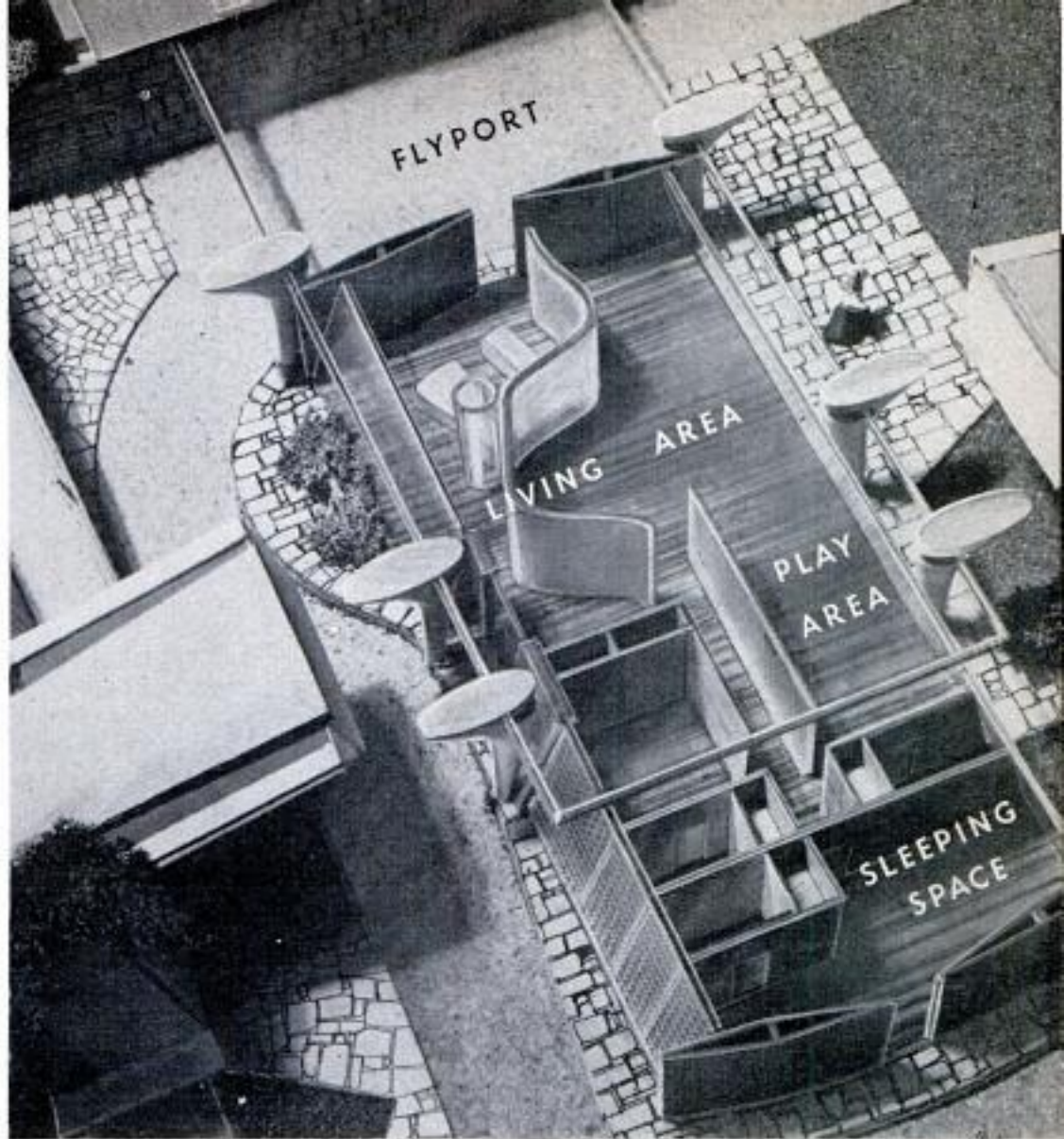

Architect's model shows how living area is separated from sleeping area. Concrete pillars support the roof

scaped parks, criss-crossed with highways like the spokes of a colossal wheel.

Shortly after the ship lands you transfer to a helicopter bus which has been waiting to whisk plane passengers to the city's center. On the way you notice there is more traffic in the air than on the streets below. Downtown, you take a taxi to the Smith home.

When you ring the doorbell, you're greeted with a cheery call coming from inside the house, where you've been recognized on the TV intercom. This, of course, comes as no surprise as home sight-and-sound hookups were common back in 1970.

What does open your eyes is the Smith's

new dishwashing system, which has only recently been installed. Because the novelty hasn't yet worn off, your hostess loses no time in demonstrating what she can do with it by just pushing a button. She serves you afternoon coffee, after which the dishes and silverware are placed in a cabinet alongside the table. The system is then set in motion and the dishes disappear through a door in the wall. A few minutes later, Mrs. Smith suggests that you step into the kitchen to see these same articles—clean, dry and sterile—neatly arranged in another cabinet there. Like all other kitchen components, she explains, this cabinet is mobile and can be raised or lowered

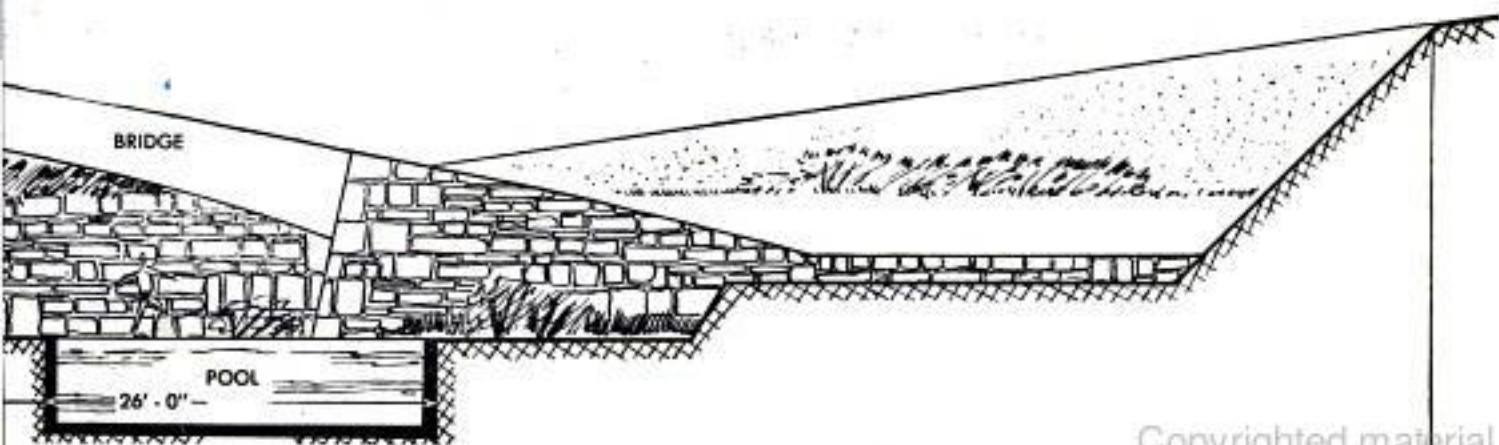

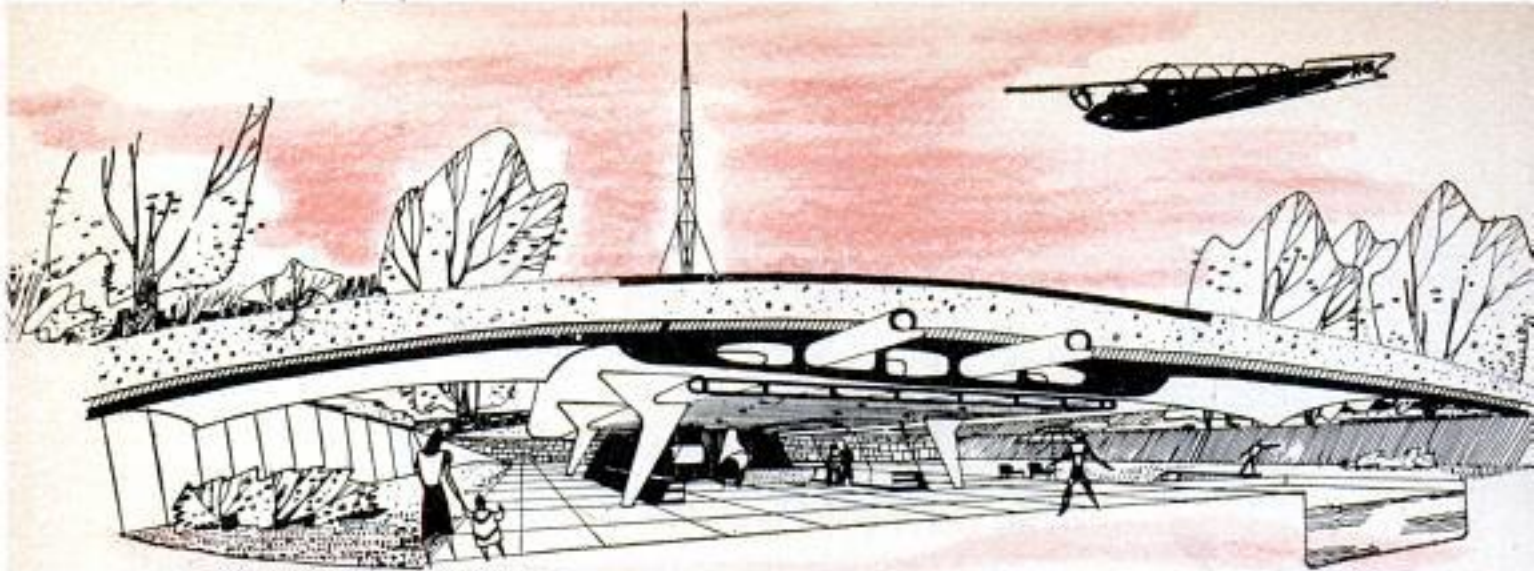

Open feeling of the house is reflected in Laszlo's sketch. Family lives on every square foot of the site

with the pull of a lever. The conveyer-dishwasher can be easily switched from one outlet to another, and preset to clean, sort and store even the finest china with speed and safety.

After suggesting a new arrangement for the kitchen, you ask, "Where's Bill?"

"He's working an extra day this week," she answers, "but doesn't mind it much. Since becoming a copter commuter he saves more than eight hours a week in traveling time. He'll be dropping down in about 10 minutes, so let's go out and watch for him."

Waiting for Bill to hover over the house, you ascend the ramp to the roof. As you look up and down the street, you're struck by the total absence of unsightly poles and the fact that nowhere in sight is there a dwelling larger than a one-family unit. Air transportation is making the multi-family apartment house obsolete, as each family now needs a private landing strip.

You're impressed by the aesthetic landscaping on all sides. Even a casual glance shows you that the Smiths and their neighbors have brought true meaning to that mid-twentieth-century housing cliché of "living on all of your lot." Although the homes are hidden under earthen shells, these coverings are open at the sides and the buildings are surrounded by terraced lawns and gardens.

Dozens of helicopters, convertiplanes and other aircraft are coming and going overhead and you watch a "converti" come to rest on a roof up the street. Mrs. Smith points out that they use their car mostly for visiting in the neighborhood and hardly ever drive it outside Atomville.

Right on schedule, Smith sets his six-passenger helicopter on the near-by landing strip, then hops out to shake hands with you. He takes you aboard the copter, taxis down the ramp and parks it in the flyport. Later, as you sit chatting by the swimming pool, he tells you how he came close to

colliding with a converti on the way home when the pilot flying in front of him failed to signal for a drop-down.

"It's a good thing our 'eggbeater' has a radar safety system," he remarks. "They'll probably make it compulsory equipment any day now."

The foregoing glimpse of family life in the next century is no idle daydream. It's the authoritative view taken by California architect and interior designer Paul Laszlo, who has pioneered many of today's building trends and accurately predicted others. This forecast is the result, not only of the 30 years in which he has become increasingly famous for design, construction and decoration, but of three years of study and experimentation during which he conferred with manufacturers, transportation heads and communications experts, as well as architects and contractors.

To some, perfection of the hydrogen bomb has meant profound anxiety; for others, it holds the promise of permanent peace. Laszlo looks beyond both and sees it as the beginning of a period of unprecedented progress out of which must come a whole new way of life.

"I think of how the atomic-age houses will look," he says, "when man's mastery of the atom will maintain life. Innovations will become apparent that will make Bucky Fuller's Dymaxion house and his geodesic dome appear old-fashioned. When I say that the family of the future will go underground, I'm immediately categorized as a political pessimist. Let us say I hope for the best, but would want to be prepared for the worst.

"Subterranean construction would not be just a protective measure. To begin with, air transportation will be the main mode of travel, requiring an absence of obstructions and an abundance of landing areas. Increasing population will put a premium on acreage and will eventually

(Continued to page 266)

PARADE OF HOMES

..\$7,250 to \$15,000

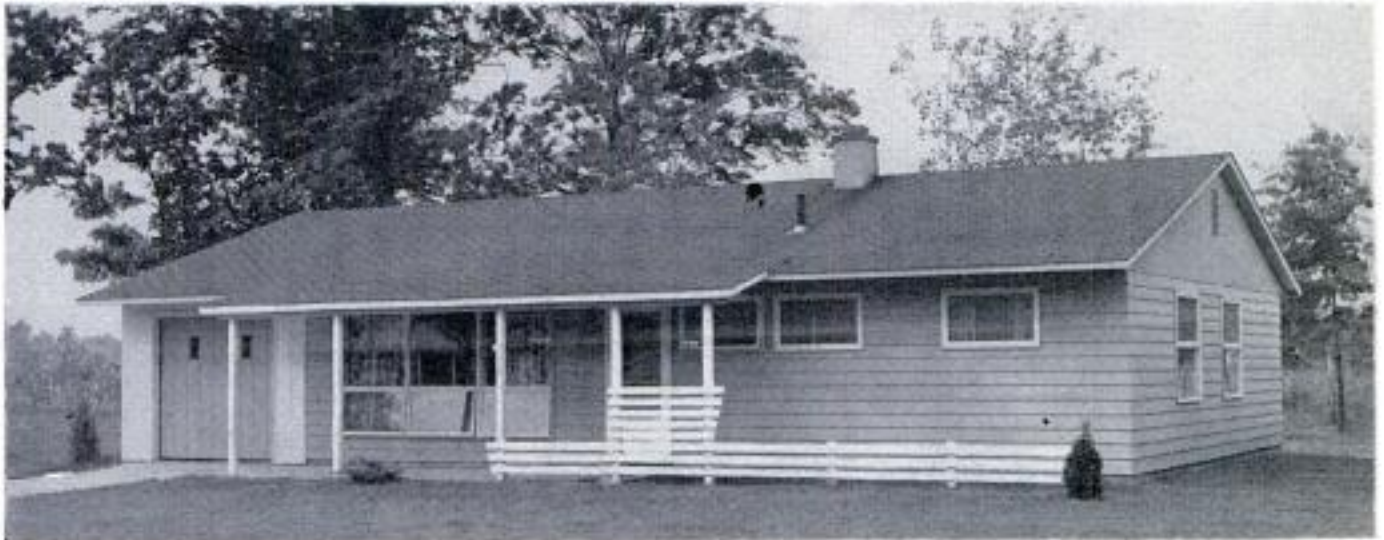

Built in South Bend, Ind., by Place Homes, Inc., this three-bedroom frame house sells for \$14,750. The foundation is slab. It was designed by William A. Weist. Floor area of the house is 1120 square feet and the garage 392. Roof overhang extends six feet

Three bedrooms, 1½ baths
Floor area—1120 square feet
Price—\$14,750 (not including lot)

The eight houses featured in this parade of low-cost homes were selected by the editors of *Popular Mechanics* for their economy, livability and excellence of design. Simplicity, both inside and out, is the keynote of every one of these distinctive homes. They were designed and built by some of the best architects and builders of low-cost homes in the nation. The localities where the houses have been built span the country from New York to California and the Northwest but, regardless of where they have been constructed, each house would be "at home" in almost any part of the United States.

Three bedrooms, two baths
Floor area—1389 square feet
Price—\$15,000 (not including lot)

Designed by Rudolph A. Matern & Associates, this brick-veneer house was built by Morton Brothers in Plainfield, Long Island, N. Y. It features a living room at rear. Minimum lot size required is 65 by 100 feet. Has a full basement with oil-fired warm-air furnace and gas water heater. The kitchen has birch cabinets, double porcelain sink and included in the price are gas range, a wall oven and fans



Three bedrooms, one bath
Floor area—882 square feet
Price—\$9750 (including lot)

This house was designed and built by Crawford & Conover, Inc. (Albert Balch), Seattle, Wash. It is of frame construction with vertical siding. The three-ply built-up roof has wide overhang. Floors are of hardwood and the forced warm-air heating system is of the perimeter type. The carport with storage space at rear could be easily enclosed as garage



Three bedrooms, one bath
Floor area—1250 square feet
Price—\$14,700 (not including lot)

This home may resemble California houses in style, but it was constructed to withstand Minnesota winters by Norsen Company (Robert A. Norsen), designers and builders, Minneapolis. It has a special slab foundation and the floor is covered with insulation board and cork. All windows are double glazed. Interior view shows end of living room with big windows, paneled wall and vaulted insulated ceiling





Three bedrooms, two baths
 Floor area—1255 square feet
 Price—\$14,750 (including lot)

Architects Jones & Emmons of Beverly Hills, Calif., have used glass walls and doors along with open planning to give this home a spacious effect. It was built by Eichler Homes, Palo Alto. View of rear patio shows glass area of living room. Other features include radiant-heated slab floor, wood paneling in all rooms, cork floor in living room, beamed ceilings, insulated roof and concrete patio. Price includes electric range



Two bedrooms, one bath
 Floor area—790 square feet
 Price—\$8500 (including lot)

Built in Beaverton, Ore., this house was constructed on a wooded lot with attractive exterior siding of lapped rough cedar. The low-pitched roof with wide overhang at the front has slots to admit extra light to the big living-room windows. All windows are wood frame, floors are of hardwood and the walls are plastered. The house was designed by Home Building Plan Service Co. and recently constructed by Franklin & W. W. Nelson of Portland



Four bedrooms, two baths
 Floor area—1100 square feet
 Price—\$10,000 (including lot)

Bedrooms in this house are 12 x 11, 13 x 9, 11 x 10 and 11 x 9. The living room is 18 x 12. It was designed and built by the Earl W. Smith Organization in El Cerrito, Calif. Construction is frame with stucco exterior and dry-wall interior, beam-and-plank roof topped with insulation and three-ply tar-and-gravel surface. The foundation is concrete slab and all floors are asphalt tile. Heat is supplied by two wall units. Two-car garage has overhead door



Three bedrooms, one bath
 Floor area—1042 square feet
 (including garage)
 Price—\$7250 (not including lot)

Front entryway permits access to bedrooms or kitchen without going through living room which is at rear. Fireplace with open space above adds pleasing effect. Construction is with a slab foundation and conventional frame, hardwood floors except kitchen and bath which have asphalt tile, composition roofing. Doors and kitchen cabinets are mahogany. Designed by Mogens Mogensen and built by David D. Bohannon of San Mateo, Calif.





Are you planning to build your own home? Here's advice from three men—a Pullman conductor, an engineer and an artist—who have done just that. We invited them to our Chicago offices for this discussion which is climaxed with the \$64 question:



Would You Build It

PANEL PARTICIPANTS: *H. E. Lindblom, Arcadia, Calif.; Herbert Schildt, Mount Kisco, N. Y., Robert O'Neil, Glen Ellyn, Ill.*

QUESTION: What is your occupation and what previous experience in the building trades had you had—such as carpentry and masonry—before you built your own home?

O'NEIL: I am an artist, do layouts, cartoons and all that sort of thing. When I was in Aspen, Colo., before coming to our Chicago suburb of Glen Ellyn, I did some rough carpentry work. In high school, I built some cabinets.

SCHILDT: I'm an engineer and live in Mount Kisco, N. Y. The only experience I had was field work for a large contracting company.

LINDBLOM: I am a Pullman conductor. That gave me a little better break than the average man in building because I'm a week on the road and a week at home in Arcadia, Calif. A number of years ago I built an addition on a small house.

Q: Are ownership of and experience with power tools essential in building your own home?

O'NEIL: I started pretty much from scratch. I bought a portable electric saw and started using it.

SCHILDT: Power tools aren't necessarily essential, but they are a great help in the time factor. I had a bench saw given me, and I bought a portable saw and an electric drill.

LINDBLOM: I wouldn't attempt to build a house without at least two essential electrical tools, a portable saw and a bench saw.

Q: What hand tools did you use?

O'NEIL: Hammer, hatchet, hand saws, an ax for making stakes and so forth.

SCHILDT: One of the most important is the carpenter's square. When I started cutting rafters, I measured the first one I cut with a tape and I said to myself, "There must be an easier way." I got a carpenter to show me how to use the square.

LINDBLOM: I would like to mention a little gadget I made myself which was a tremendous help. I took an eight-foot pole and marked it off in the middle. That gave me a four-foot measure. In between, I had marks for my 16-inch centers. Whenever I found I needed a rather long measurement, say 10 or 12 feet, I used this pole along with my steel rule for measurements over eight feet. I found I was always reaching for that pole.

Q: What did you do about preliminary plans and architectural drawings?

O'NEIL: We just went to a lumberyard and got several books of stock plans. Just picked out one we liked. I found out too late that the plan we took called for a lot of wastage of wood.

SCHILDT: I drew my own plans to conform to the length of wood that was avail-

able in the lumberyards. The plans were approved by the building inspector before a construction permit was issued. One thing I learned in buying lumber is that when you buy 2 by 4s, always buy a 16-foot length. Never buy 8-footers, because when you are cutting your studs for an 8-foot ceiling height with your sill and your double plate, you are cutting off approximately 5 inches on an 8-foot piece. If you have a 16-footer, you cut off 10 inches plus the two inches that is oversize. This gives you a 12-inch piece that can be used for a lot of things, whereas 5-inch pieces are just scrap.

LINDBLOM: I used *Popular Mechanics* ranch-house plans and bought my lumber according to specifications. I found the plans to be very specific and had no trouble. I had no construction problem or actual building mistakes.

Q: How did you decide to build your own home?

O'NEIL: I read somewhere that approximately a hundred thousand people a year are building all or parts of their houses, so I figured we could do it too and get a lot more house by putting in our own labor.

SCHILDT: My wife, Mary, and I looked at homes on Long Island where we lived. The prices were away out of our reach so we decided to build our own place.

LINDBLOM: I also found the prices too high for us. We bought a half acre in Arcadia with a small house on the back of the lot and a two-car garage in the front.

Q: Did you select the type of home you built because you thought it would be easier to build yourself?

O'NEIL: Not particularly. We just picked a ranch-type plan we liked.

LINDBLOM: We followed the Tom Riley



Yourselves Again?



Mr. and Mrs. H. E. Lindblom pose in front of the PM Ranch House which they built themselves for \$7000, not including lot, in Arcadia, Los Angeles suburb

Lindblom: "I figure it took me 4½ months of actual building . . ."



Floor plan of Lindblom home shows careful planning for basementless house. Den with adjoining half-bath can serve as third bedroom. Floor area of this house, not including garage, is 1350 square feet



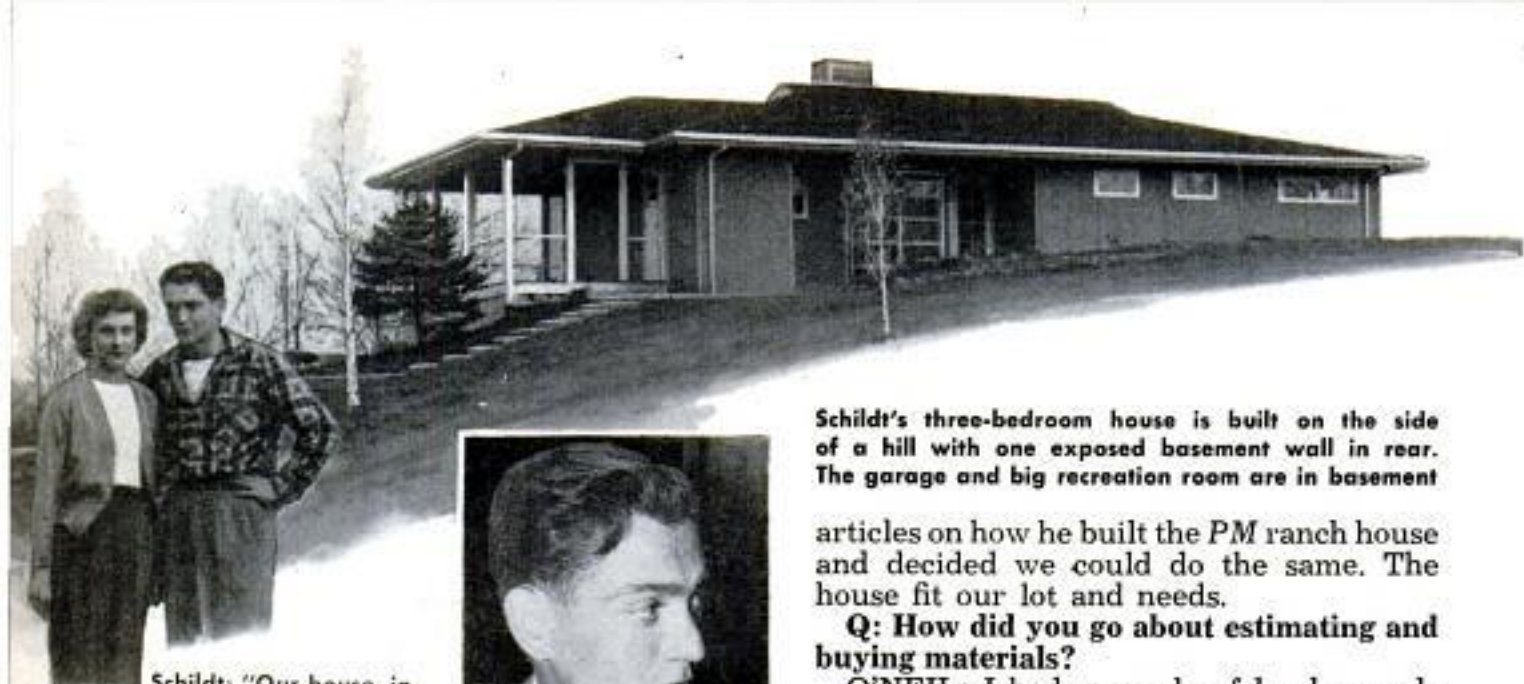

Schildt: "Our house, including lot, cost me \$18,000. It's worth all of \$35,000 right today."



Schildt's three-bedroom house is built on the side of a hill with one exposed basement wall in rear. The garage and big recreation room are in basement

articles on how he built the PM ranch house and decided we could do the same. The house fit our lot and needs.

Q: How did you go about estimating and buying materials?

O'NEIL: I had a couple of lumberyards estimate it. I found they estimate as low as possible. When you actually come to buying materials they run a lot higher.

SCHILDT: I figured out the materials I needed and then sent my plans to several lumberyards and let them figure. They came out with much more lumber than I specified and they were right. My wife did the buying. She called every lumberyard for miles around and said, "We need so much of this. Will you quote us?" Somebody would say \$130 a thousand, and she would say, "Sorry, not good enough. I had an offer of \$108." They would say, "We'll give it to you for \$106." You can save a pile of money if you shop around. A contractor I knew gave me the glass for the windows. I think our lumber was originally estimated at \$3000 and came closer to \$4000.

LINDBLOM: I found figures in the plans I used very accurate. I had no problem. I showed the plans to several lumberyards and they made estimates.

O'NEIL: It's a good idea to consult your building commissioner before you make final estimates. He changed the spacing on my floor joists and that added to the materials right there.

Q: Mr. O'Neil and Mr. Schildt, do you feel you would have saved any money if you had used carefully worked out how-to-do-it plans?

O'NEIL: I certainly do.

SCHILDT: I could have saved quite a bit because I made some foolish mistakes.

LINDBLOM: I feel that the how-to-do-it plans helped me enormously. I followed those plans to the letter with the exception of a few changes the building commissioner made in regard to window headers.

O'NEIL: In my case, I took the floor plans, put the basement in, and from then

(Continued to page 276)

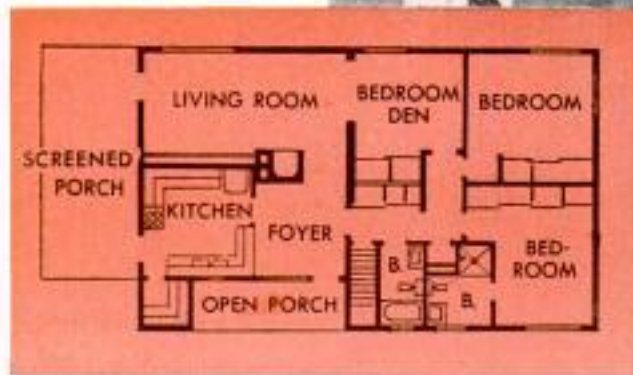

O'Neil: "If I put it up for sale I might get \$25,000. It cost me \$14,000 plus my labor"

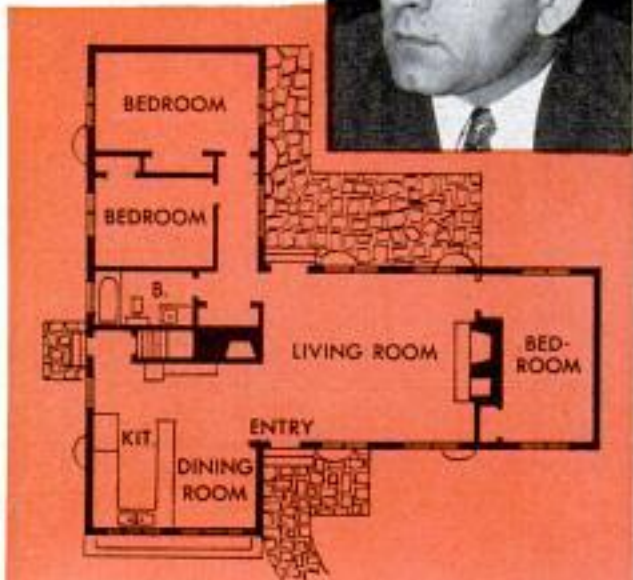

Left center, the O'Neil family stands proudly in front of their new Glen Ellyn home. The house has a full basement, two fireplaces and patio at rear

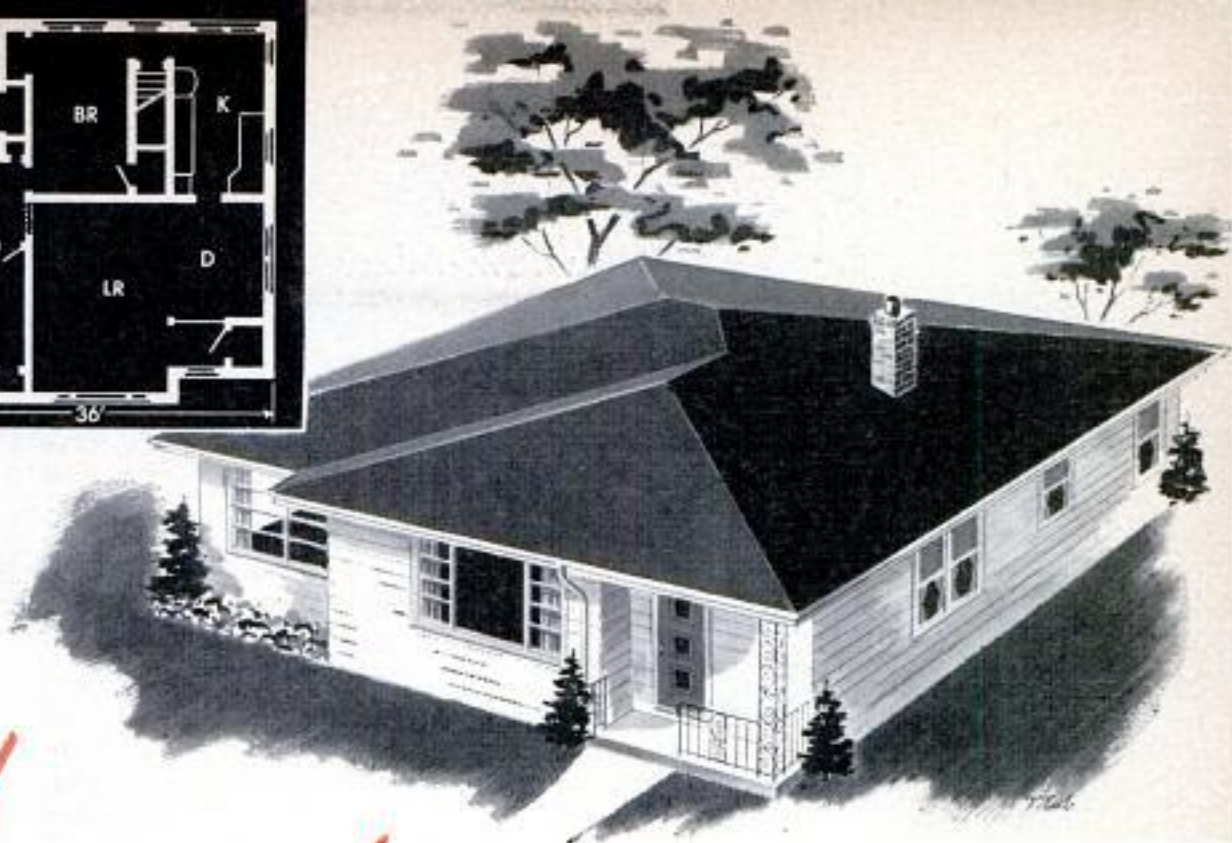

How much WILL IT COST?

UP GOES the price every time you add anything to a basic house plan. Above is a typical three-bedroom home. The specifications call for the best of materials, including automatic heat, birch cabinets and doors, Formica countertops, a double-glazed picture window, a tiled bath, and vinyl floors in kitchen and bath. Murray & Ingle, experienced building contractors of Villa Park, Ill. (a Chicago suburb), made

the bids shown below. Building costs in your area may vary widely from those around Chicago. However, the costs shown here will give you a comparative idea of what it will cost to add items to a basic house plan in your area. If building costs in your area are lower, each of the costs shown here likely will be lower, but relationship between items will be about the same. The bids do not include price of lot.

	Basic home in frame	\$15,900
	Basic home in brick veneer	16,800
	Add a full basement	1,000
	Add a one-car attached garage in frame	1,200
	Add a two-car attached garage in frame	1,650
	Add a one-car attached garage in brick	1,500
	Add a two-car attached garage in brick	1,900
	Add a fireplace	650
	Add a 12-by-14-foot porch (roof and floor only)	1,000
	Add the same porch with jalousie windows, screens	2,000

	For each square foot added to the home in either brick or frame	\$14
	Each additional electric outlet not shown in plans	7
	Replacing door in plan with a disappearing sliding door	26
ALLOWANCES		
	Allowance for decorating the home yourself	650
	No tile in bath	175

 Cost of brick-veneer home, full basement, attached two-car garage, fireplace, finished porch — \$22,350

Plan Your Home With Circles

by Tom Riley

HERE'S AN EASY way of planning your new home. You doodle with circles. This is both simple and basic and gets down to blending the good and bad features of the lot with the things you want most in the house and that is an important factor often overlooked in the welter of scaling door sizes, joist supports, window arrangements and similar details. Or perhaps you have selected a certain house plan before purchasing your lot. Then you see a lot you are tempted to buy. This circle method will quickly indicate whether the house plan will fit the lot and, if so, how to place the house on the lot. It may show that the plan should be reversed from side

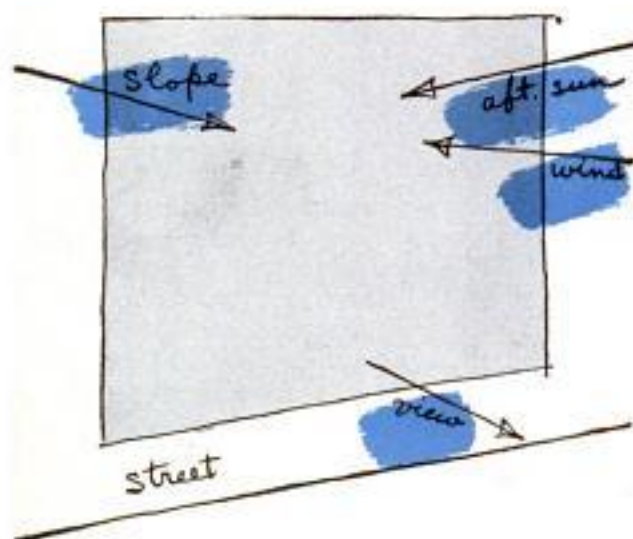

to side, or front to back. Or, perhaps you are planning to remodel your present home. The circles can be a great help in deciding where and how to change the rooms.

Let's take the common example of a suburban lot on an open hillside. First we draw our lot fair-sized on a sheet of paper, as in the above illustration. Next step is to spot in the basic features of this particular site, the things we cannot change now or later. So we draw an arrow showing the general slope of the land. The lot has an excellent view in a certain direction, so we indicate that important asset with another arrow. On a spring day we just can't find any defects in this pleasant site, but we have enough foresight to question some of the neighbors. We find that the afternoon sun can be very hot on this slope and that bedrooms facing the sun in some of the near-by houses do not cool off in summer until after midnight. That doesn't

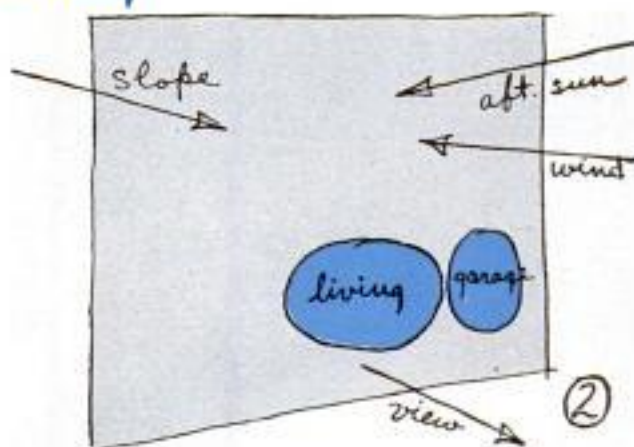

sound so appealing. And we find that the prevailing wind is a problem on this open hillside, cooling exposed patios too quickly for leisurely summer dinners outdoors and rattling any exposed bedroom windows on winter nights. These are basic features which we can't change—though we may be able to counteract them—so we arrow in the wind and afternoon sun.

Now we can locate the rooms to fit this lot the way we want to live. Suppose, above all, we want the full beautiful view from the living room. In Fig. 2, let's indicate the living room with a circle placed toward the front of the lot and to the right, which is the view side.

The lot is high on the left side but just about at road level at the far right. By placing the garage there we would have a level driveway. We also note that the wind is from that direction and, as the garage makes a fine windbreak for any house, this

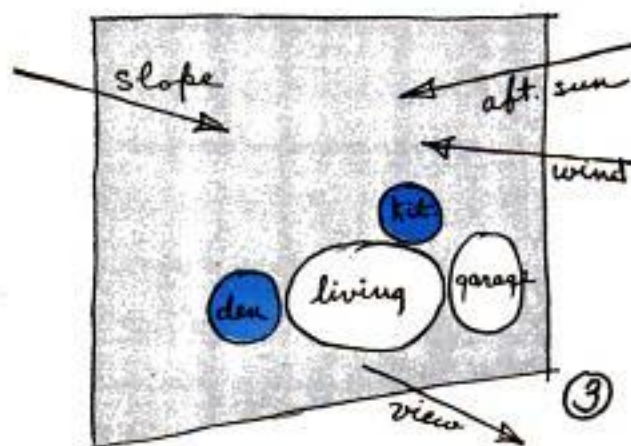

pretty well cinches the garage location. We place it a bit behind the living room to avoid blocking any view.

We've a yen for a den in our new home, and it, too, must have a view. So, in Fig. 3, let's put it alongside and a bit forward

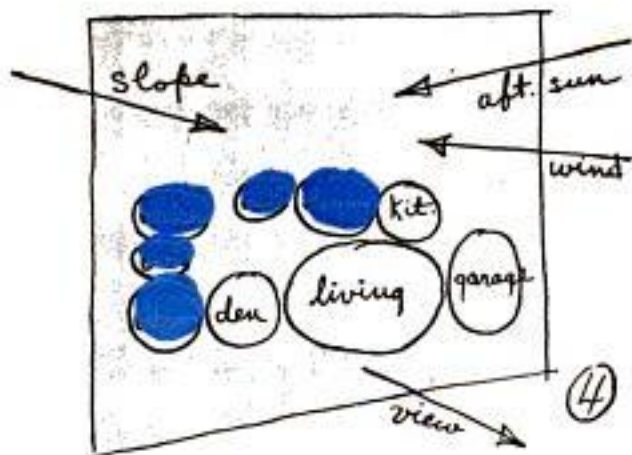

of the living room. We want the kitchen facing a secluded garden patio. This will make it easy to serve some of our meals outdoors. We circle it in behind the living room, handy to the service area of the garage. It would be fine if the dining room, too, could open up on the patio. In Fig. 4 we place it alongside the kitchen where it will be accessible to both.

We circle in the bedrooms on the left side of the house, away from the sun, wind and household noises. We've decided to splurge a bit on a private bath for the master bedroom, so we place that so it will seclude the bedroom from the patio area. We place the other bath fairly handy to the den, so the den can be used as a third bedroom whenever we have overnight guests.

We want a utility room. Where? In Fig. 5, let's try it behind the garage. There it and its service yard will serve as a further sun and wind barrier for the house proper.

Finally, we need halls and entranceways.

We indicate them with small circles. Now our plan is complete and, without a confusion of details, quickly shows whether we've succeeded in joining the house and the lot.



Below is one of a number of floor plans that can be worked out for this one arrangement. The exterior of the house can be as modern or traditional as you wish. If you have a knack for drafting, you can work up the final floor plan yourself. Best of all, it will have no clash with the site. Perhaps you prefer to look among house plans for one that fits. Or even better, take your doodling to your architect—it will be invaluable to him. ★ ★ ★

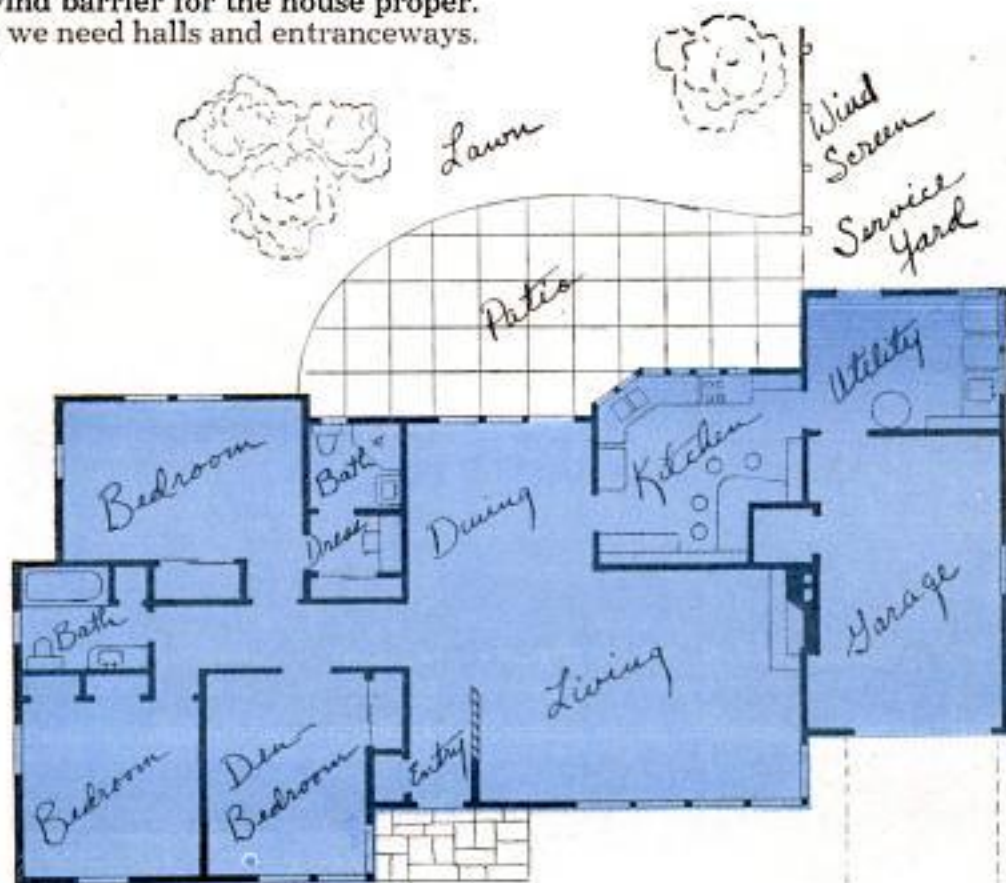
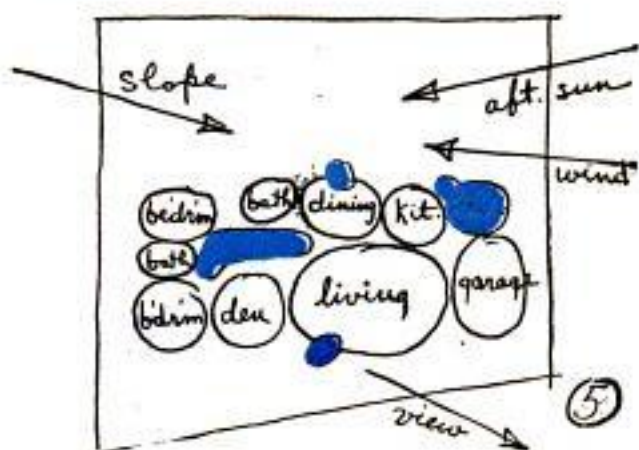

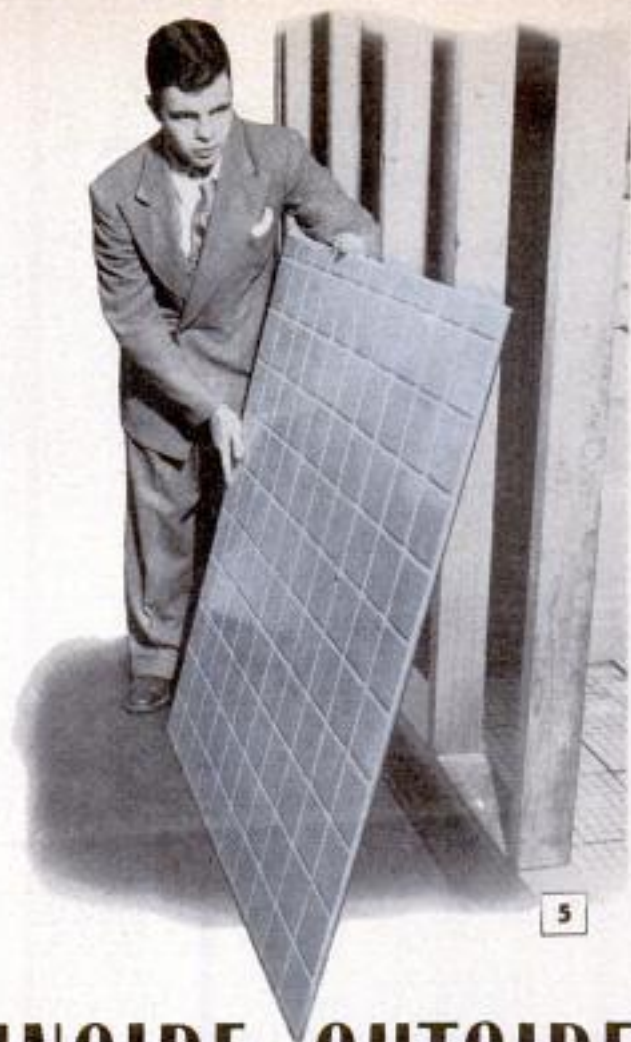
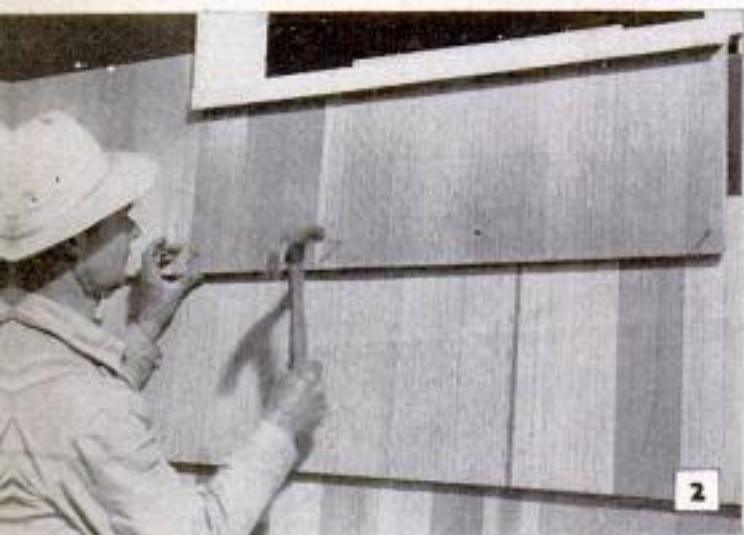
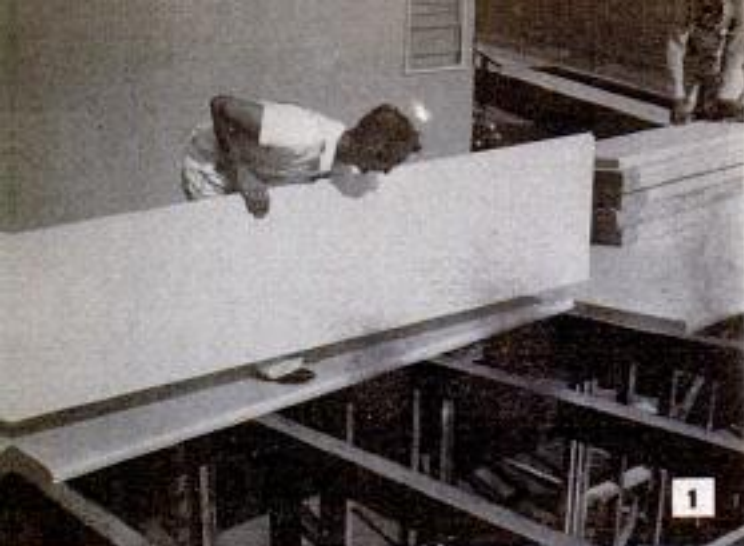

INSIDE, OUTSIDE

1. ROOFING PANELS serve three ways—as roof sheathing, roof insulation and as a prefinished ceiling. Three men can lay 1000 square feet of the tongue-and-grooved panels in two hours. The material, suited for exposed-beam construction of low-pitched roofs, can be given finish of built-up pitch

Insulite, 500 Baker Avenue Building, Minneapolis 2, Minn.

2. SIDING PANELS eight feet long provide a cedar-shingle exterior, yet are quickly applied. The panels are laminated, with machine-grooved cedar shakes on the outside, veneer stripping in the middle and shingle undercoursing on the bottom. Panels give a heavy shadow line and have few exposed nailheads

Shake-a-Ply Company, P. O. Box 577, North Portland, Ore.

3. WIDE BRICK is a through-the-wall unit, needs no back-up materials. Coring holes reduce weight and facilitate handling. The brick is 2-1/6 inches high, 11 1/2 inches long and 5 1/2 inches thick. It enables a mason to lay more wall per day, is said to bring the price of brick down to that of frame construction

Structural Clay Products Institute, Washington 6, D. C.

4. GLASS BLANKET serves as an underlay for new siding on old buildings. Lightweight and resilient, the glass-fiber cushion acts as a heat barrier and is fire-resistant, rotproof and nonabsorbent. The easily applied material comes in 12 1/2-pound rolls 200 feet long, two feet wide and 1/2 inch thick

Owens-Corning Fiberglas Corp., Toledo, Ohio



AND ALL AROUND THE HOUSE

5. TILE PANEL, not yet in production, would slash the time needed to line bathrooms with genuine clay tiles. The large units can be installed easily by the amateur craftsman. Rutgers University's Tile Council Research Center developed the prefabricated panel, which may revolutionize use of the material

Tile Council of America, 10 East 40th St., New York City 16

6. CARPORT which doubles as patio shelter comes in kit form. Two men can assemble and erect the lightweight aluminum sections in a few hours. The W-shaped louvers keep out rain but allow the passage of air, diffused light, and smoke from a portable fireplace. Lustrous finish of shelter needs no paint

Kawneer Company, Niles, Mich.

7. PLYWOOD SIDING that is beveled for fast application requires no wedges at joints or edge-furring strips. A smooth resin-fiber surface bonded to the plywood provides a good paint base and gives protection against checking, grain raise, blistering or peeling. Deep shadow lines add to appearance

Walton Plywood Co., Inc., Everett, Wash.

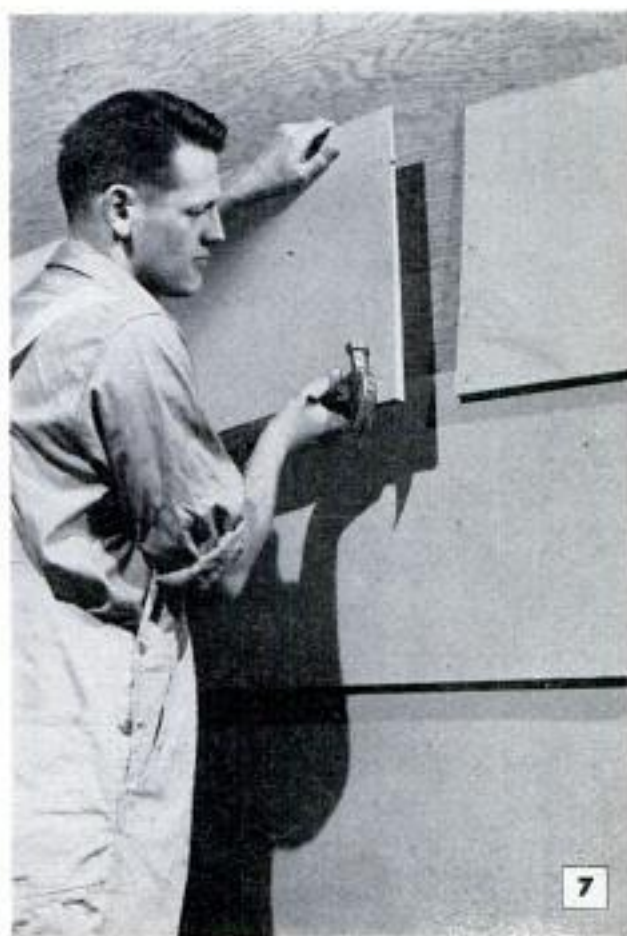



He Builds a House in SECTIONS SECTIONS

Cliff May demonstrates his patented sectional home which will fit many floor plans by juggling panels



Floor plan above can be varied depending on arrangement of the sections. None of the interior walls is load bearing. Below, exterior wall panels complete with posts go up first; then interior partitions. Below right, attractive bedroom is of ample size

HERE'S A LOW-COST HOUSE with two bedrooms that can be erected in a day, then completed for occupancy 17 days later. The design is modern with as much or as little glass as you want, and its prefabricated wall sections can be arranged to fit almost any floor plan you desire. Two thousand of the homes have been built so far and recently the demand has jumped to almost 10,000 units. The reasons are low cost and attractive design.

The house sells for about \$10 per square foot complete with land and financing. Cost of a single house is somewhat higher. On a tract basis the cost is less. One typical five-room house measures 22 by 38 feet exclusive of carport and contains 836 square feet of living area including a dinette as well as a dining area in the living room, and a full bath. The exterior is finished in wood siding, the interior in dry wall.

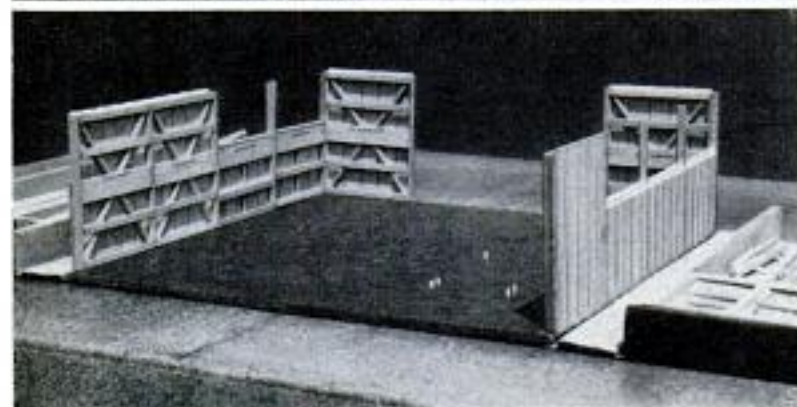
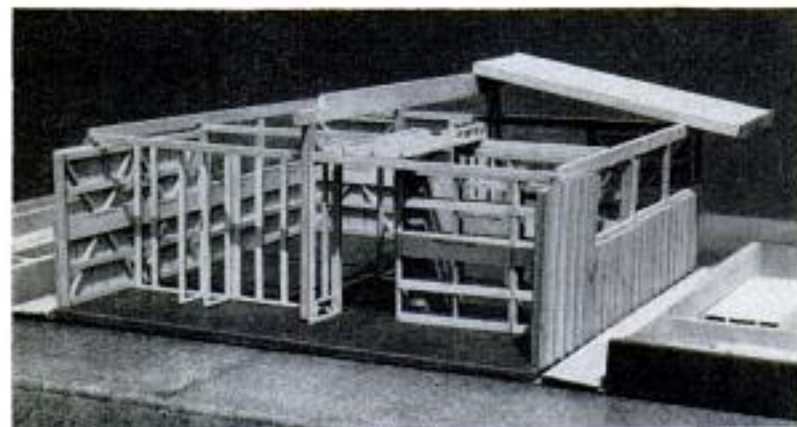



Prebuilt kitchen cabinet wall made of hardwoods is moved into a new May home



Interior view shows the effect of spaciousness achieved in a typical sectional house by the use of glass walls and doors

Interior partitions are preassembled and then erected on the job.

Designed by Cliff May, Los Angeles builder, and by Chris Choate, architect, the house is based on a post, beam and panel system of construction.

Three basic panels are used in the exterior walls: solid wall panels, window panels, and glass frame panels. Each panel is five feet wide and each has a 2 by 4 stud at either end. When the panels are erected side by side, the adjoining 2 by 4 studs become 4 by 4 posts that support the roof. The exterior wall panels go up first, then overhead cross beams and ridge-pole tie the structure together. The roof is made of plywood panels overlaid with roofing paper, tar and gravel. ★ ★ ★



Adjoining studs at ends of panels form post to support roof. Below, home made of same panels as model has different look



LOOK WHAT YOU CAN DO WITH DOORS



Panaview Co., North Hollywood, Calif.

A door the size of a glass wall is featured in this small home. It is framed in aluminum and the sill track is flush with the finished floor



Hough Shade Corp., Janesville, Wis.

This folding woven wood-fabric door for catchall closet saves space. It is made of basswood slats



New Castle Products, New Castle, Ind.

Folding door with vinyl-coated fabric covering has balanced hinge construction, slides on metal track

Accordion-type wood doors separate living and dining room. They also are used in bedroom or kitchen
Bolscreen Co., Peella, Ia.

In tiny apartment, folding door of wood slats hides kitchen range and sink. It slides on overhead track



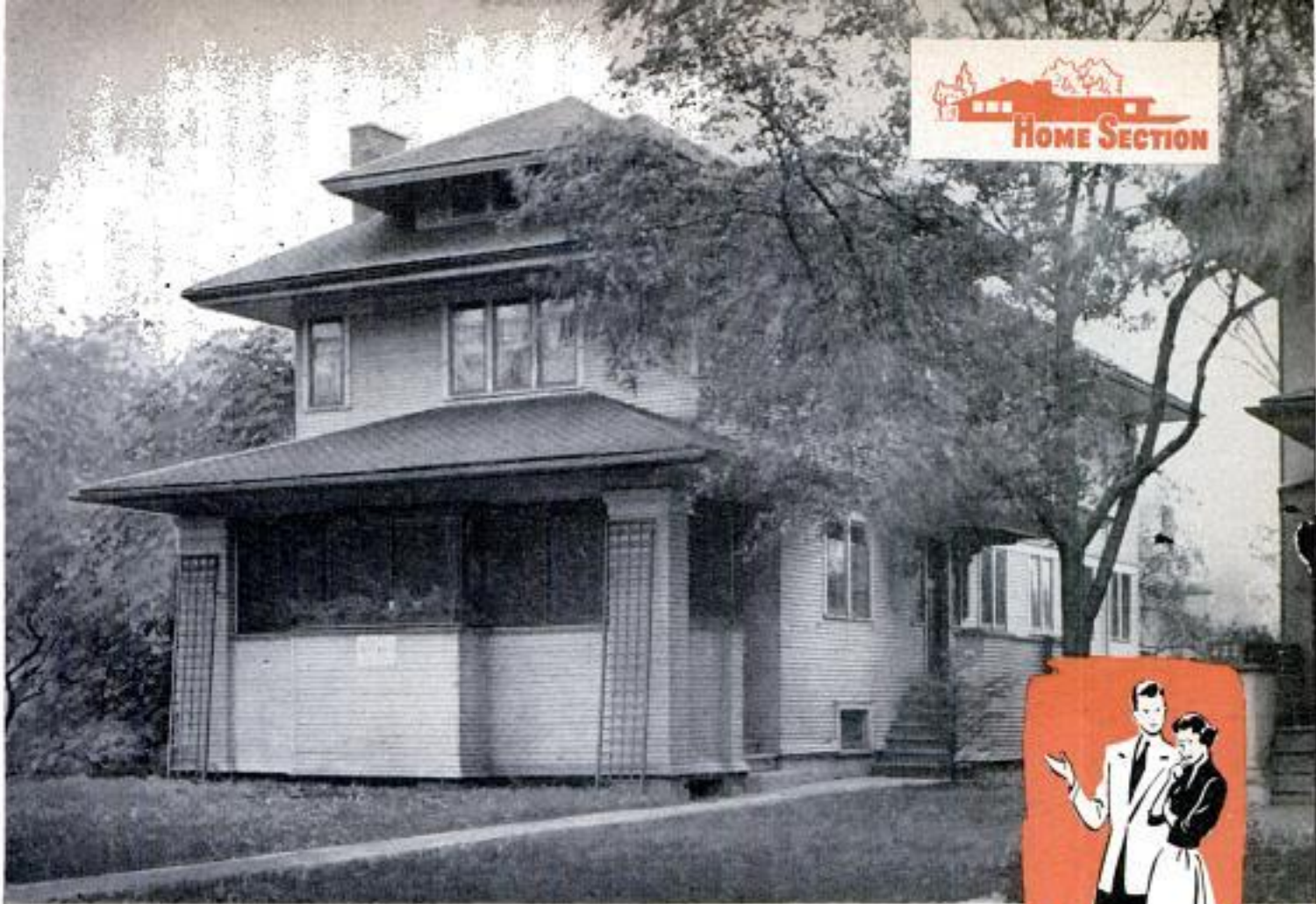

In this case, the answer to the title question is revealed by the photograph below

Is the Old Homestead Worth Saving?

By R. Kroger Williams

WHAT ARE YOU going to do about your old house?

Move out and leave its problem for someone else to worry about—or bring it up to date so it can serve you for years to come? Is it really worth any more time and money from you?

It's not easy to find a simple answer to that. So we called on an expert, W. Lockwood Martling, Jr., A.I.A., of Chicago and Oak Park, Ill. Mr. Martling is said to do as much remodeling designing as any other architect in the country. Because he also designs new houses, he can be impartial in helping owners decide on remodeling, building a new house or buying a ready-built one.

"Just how do you decide whether a house is worth remodeling?" we asked Martling.

"Do you use a check-list, or do you have

With the old front porch, wide overhang and front gable gone, this home is hardly recognizable as the same basic house at top of page. Major improvements were big window and main entrance moved to side



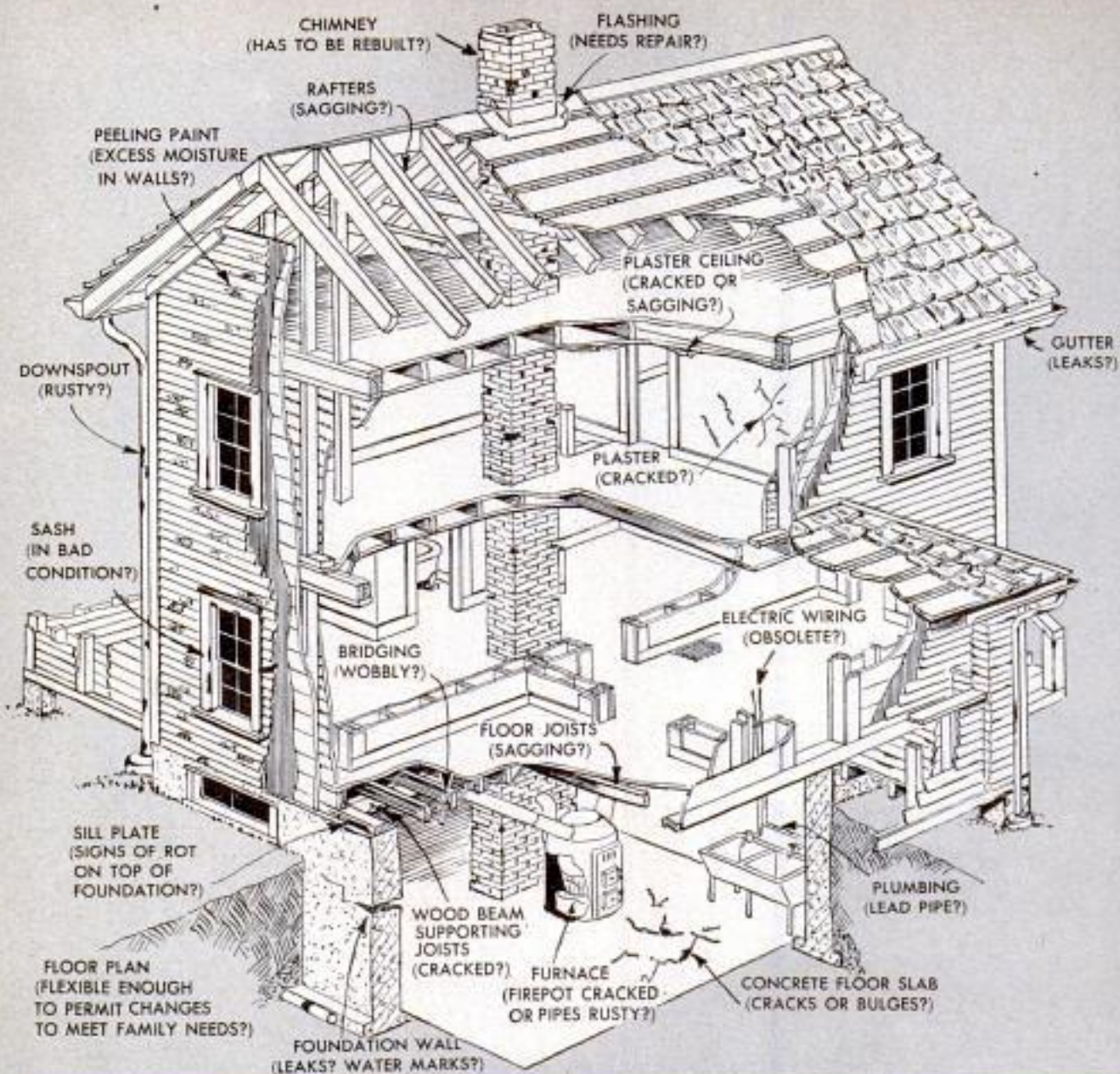

Cutaway above points out defects to look for when buying old houses. Below, floor plan should be adaptable to unified remodeling operation

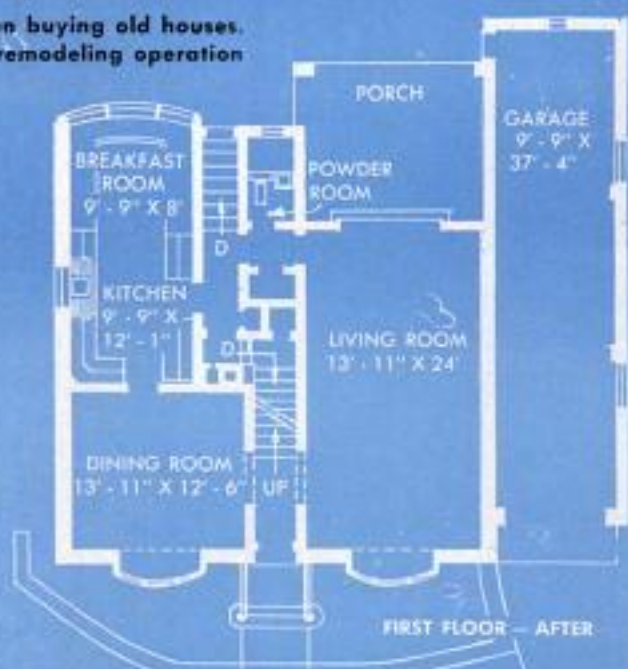
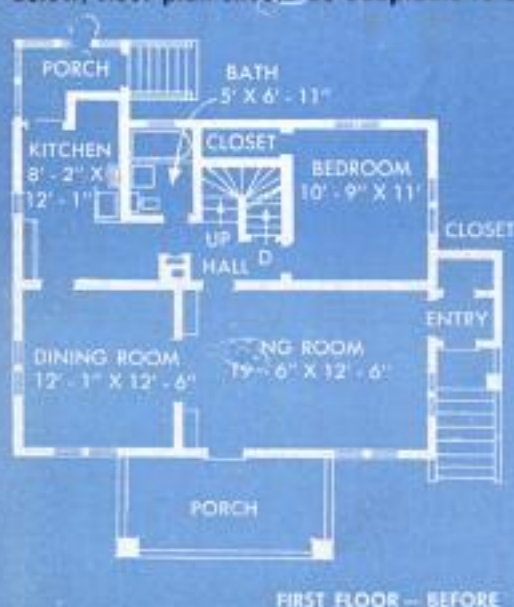

some tests you put it through?"

"Yes, there are tests, not only for the house but for the family that's going to live in it. These can be boiled down pretty well into six major parts: (1) Location of the house; (2) structure of the house; (3) flexibility of present floor plan; (4) economics of the remodeling; (5) preferences and needs of occupants, and (6) esthetics of the remodeling."

Martling illustrated these points with parts of several typical houses, choosing features common to many average homes in average communities. We will discuss these features as parts of one composite house.

Location. The typical house was in a good, upper middle-class neighborhood, with young to middle-aged couples and young or teen-age children. No neighboring slum areas or near-slum areas were present or anticipated for many years. This old house was near churches, schools, shopping areas and excellent transportation, all important factors.

Structure. The house was structurally sound. Martling studied the foundation for major cracks or signs of water leakage and found none. He looked at the wood posts supporting the main bearing walls and found them free from decay at the bottom where they touched the concrete. They did show some cracking and splitting but, unless so great as to indicate weakness, this is a natural condition in solid wood timbers in any old house.

When Martling described this "house test," he told the story of another old house he had recently studied. He noticed considerable sagging of the floors in this house. Some sagging is almost inevitable in an old house, but this was so pronounced that he was sure it indicated some structural weakness.

When the architect examined the wood supporting posts in the basement, they appeared, at first glance, to be sound.

But a closer examination proved them to be anything but that. The former owners had merely boxed in these posts, creating a false front to conceal a serious condition. Termites had eaten away the supporting posts and the sagging floors were supported only by the covering timbers.



Before and after photos of a kitchen show what can be done (above) with a room that originally had "a place for nothing and nothing in its place" (below). Good planning of units makes space for dining alcove





Changes above do not affect basic structure of remodeled home

span for their size and spacing. There should be adequate bridging between the joists to serve as reinforcement.

If the basement has a plaster ceiling, check it for cracking. Series of cracks running parallel to the main structural beams reveal weakness of the basic structure. In such a plaster ceiling, punch a small hole in some inconspicuous spot so that you can find out the size and spacing of the beams.

While checking the basement, take a look at the electric wiring. Is it old, outmoded, exposed wiring, or the newer, more desirable wiring, properly enclosed in insulated covering?

Look at the piping for the laundry tubs. If this is lead piping, chances are the entire house has similar lead piping which may have to be replaced to avoid leaks and expensive repairs.

Check the heating plant to see if the firepot is cracked or if the piping is rusted, or for other obvious defects.

Next, check the walls and floors of the rest of the house. Don't expect all floors to be true and level, but do be on guard for excessive sagging, as mentioned before. Some plaster cracking is to be expected but, again, not an excessive amount.

The same yardstick applies to the exterior, if it is stucco. Only large deep cracks are important. However, the architect warned that the same reasoning does not apply to frame houses. Chipping or

• (Continued to page 270)



Martling warned about cracking or splitting along the lower edge of beams. This indicates definite overloading. He also suggested looking along the top of the foundation, where the plate rests, for signs of rot.

He suggested sighting along the joists to see if they are straight. Sagging may mean too great a

Simple remodeling job (below left) changes a dreary entrance hallway into a place of real distinction

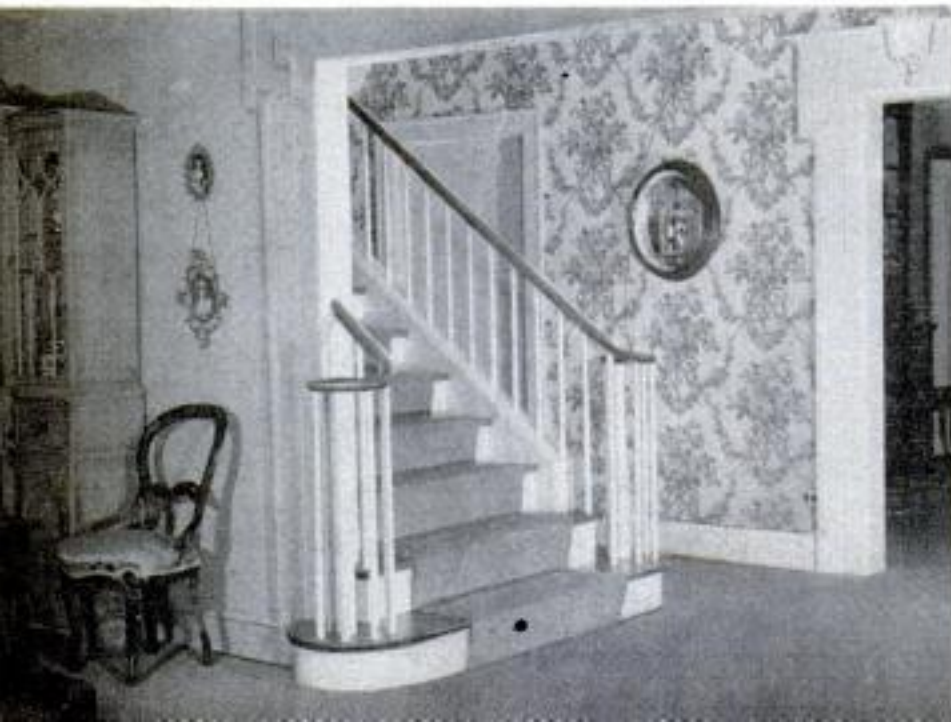



HOUSE FOR A NARROW LOT

DESIGNED for the 50 by 100-foot lot, this house has a two-car garage facing the street, three bedrooms and two baths at the back and the living room opening onto a side terrace. There is also a back yard. All of the walls are wood-paneled and the ceilings are beamed. Floor-to-ceiling glass walls and sliding glass doors are featured. Work space is available in the garage which also houses laundry and heater. The house is radiantly heated. This 1118 square-foot house was designed by Anshen & Allen of San Francisco and constructed by Eichler Homes of Palo Alto. It sells for \$13,950 in the San Francisco area, including lot, range and ventilating fan.

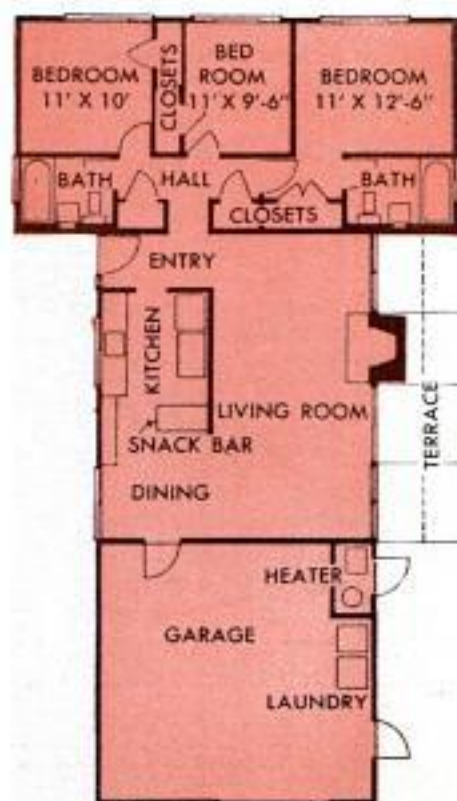

HOW DO YOU WANT IT DELIVERED?

Your answer to this question will decide what kind of a house you want: (1) precut, (2) prefabricated or (3) standard construction assembled on the site



Swift Homes Inc., Elizabeth, Pa.

PLANNING TO BUILD today? You will find yourself choosing one of a variety of delightful styles of new homes. You'll find you can also choose one of three construction methods: Prefabricated, precut or standard construction. In quality, you will find there is little difference today—you can have a cheap house, a good economical home or a very expensive home by any of the three methods. The major difference and the advantage of each are derived from the way the house is delivered to your building site.

If you build by standard construction, your materials will be delivered from one or more local lumberyards and in any dimensions desired. Thus you are not limited

to any certain house plan and your home can be tailored to fit your particular lot and needs. If you live where building materials are comparatively cheap, you or your contractor can take advantage of local lumber sales, especially if you build in the winter when prices are often less.

If you order a precut house, all of the materials including lumber, hardware, nails, roofing and windows will be delivered in one "package." In case you live in an area where the cost of materials is high, you can obtain a good saving through the precut factory's purchase of materials in huge lots. The boards will arrive cut to size, eliminating waste and up to a claimed 20 to 30 percent of the skilled labor at the

This is the way a completed wall section of prefabricated home is unloaded onto the slab foundation
Harnischfeger Corp., Port Washington, Wis.



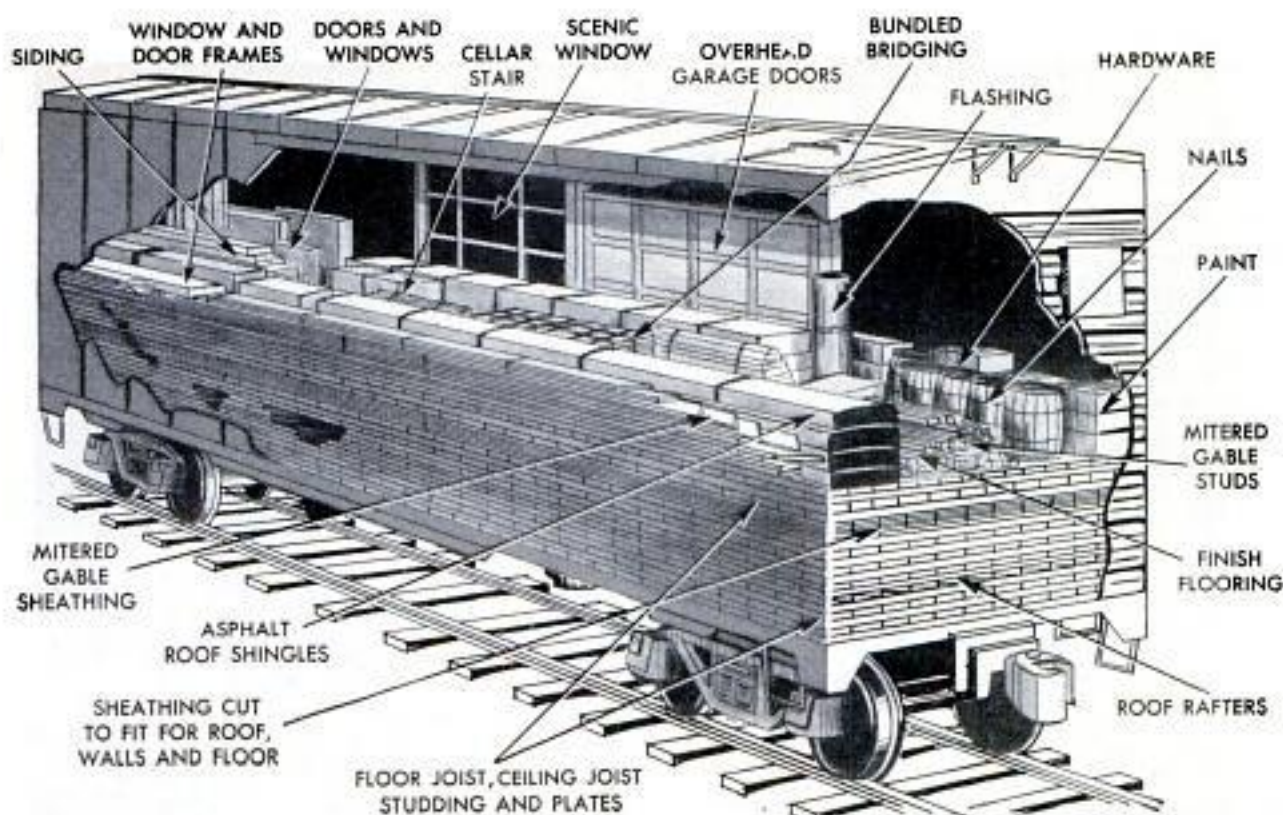

Aladdin Co., Bay City, Mich.

Cutaway of this boxcar shows the complete materials for one pre-cut house carefully packed for shipment

site. When you plan to do a good part of the carpentry yourself, the pre-cut package offers other advantages. The plans are quite complete and each board is numbered. The parts will fit. Also, the parts are all there—you spend your time building, not shopping.

The cost of a prefabricated house delivered at your lot is much higher than that of a pre-cut. However, the prefab arrives at your lot close to completion and many prefab manufacturers will deliver laundry and other appliances along with the house at big savings. ★ ★ ★

Scene of a standard-construction job—uncut lumber and other materials are delivered by local dealers

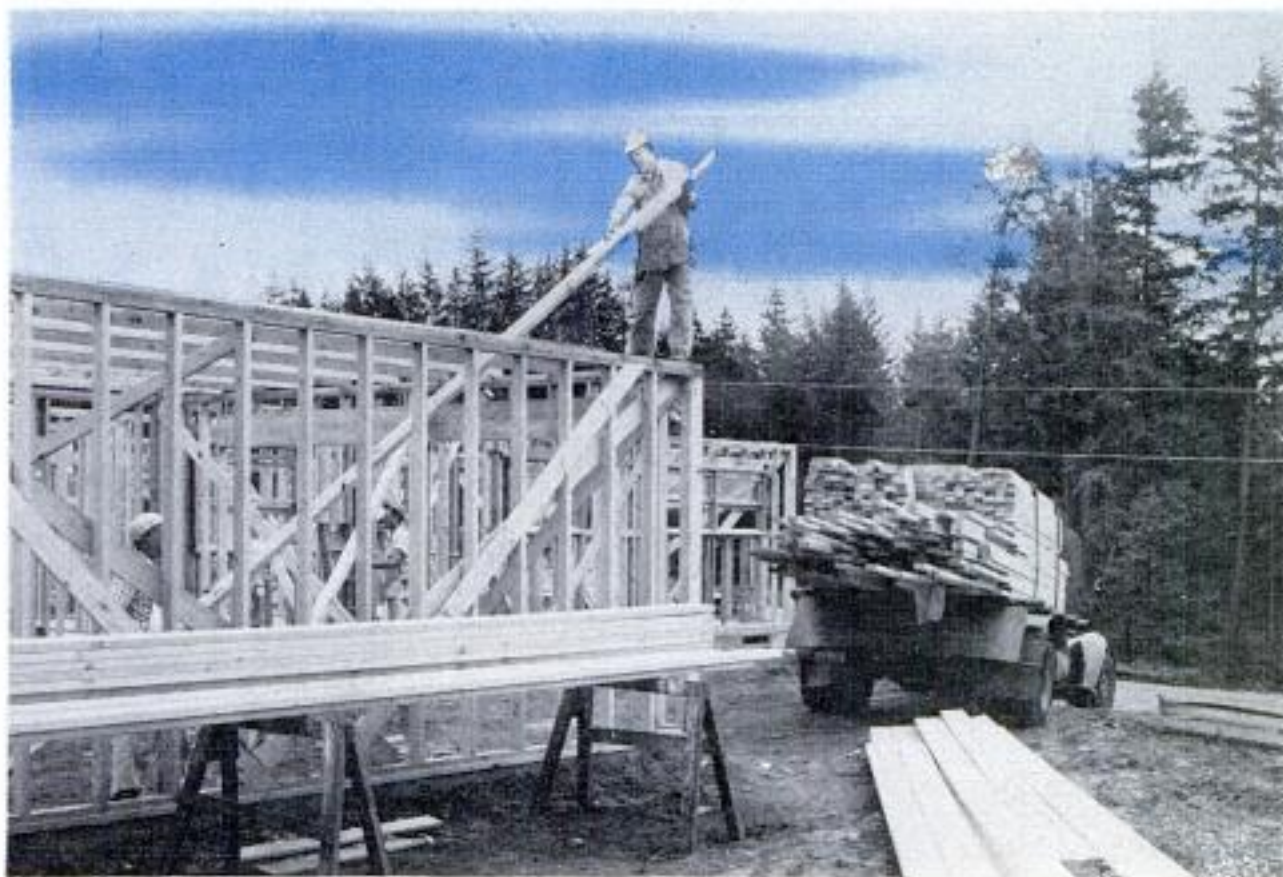

SPOTLIGHT



ON FLUSH LIGHTING

MANY A HOUSEWIFE who thinks her kitchen is completely modern would be amazed by a lighting expert's appraisal of her old-fashioned fixtures. In today's new and remodeled homes, cabinets, cupboards and major appliances are built-in to eliminate broken lines and do away with dust-catching surfaces. This idea is equally applicable to lighting; but only the most progressive homeowners take it into account, probably because the average person is not familiar with the remarkable advances that have been made in the designing of recessed or "flush light" fixtures.

Flush lights offer not only great variety in appearance and use, but they can be combined with recessed heating and ventilation units. Because they have no protruding surfaces to gather grease and dirt, they are more easily cleaned and maintained. Despite their streamlined design, there are models to harmonize with all types of furnishings.

The single unsatisfactory feature of recessed lights used to be that they did not light the ceiling like more conventional fixtures. However, a new prism-lens, pyramidal-reflector unit solves this problem. It illuminates the ceiling and provides even distribution of light at floor level, yet gives no objectionable glare at the "approach angle" or line of vision when you are looking at the light from either a sitting or standing position. Most of the light is directed toward the floor, but a series of prisms arranged around the fixture's outer edges reduces the amount of light issuing at the approach angle and bends some of the rays upward toward the ceiling. A modified model for corridors has an asymmetric lens which directs the light length-

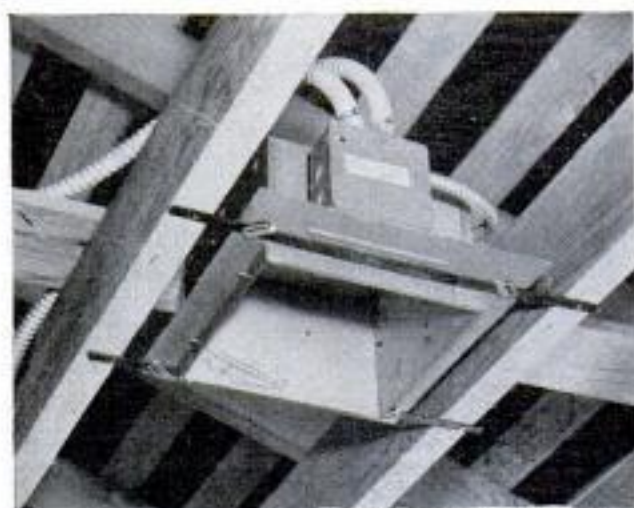

Fryne & Co., Pomona, Calif., photo
Top, even the inside of the lens on this flush light can be cleaned without removing the fixture frame. Mounting strips on lights make installation easy

wise without excessive glare on the walls.

The new flush lights are easily installed in old or new construction. No framing-in is necessary and built-in junction boxes are accessible from either side. Recessed lights may be lamped from above or below, are prewired for use with any standard building wire and, with mounting strips provided, there is no need for extra help or awkward, dangerous contortions to fasten a fixture into position. The snap-up lens frames can be raised, lowered or removed for inside cleaning and come in several different finishes.

In addition to ceiling installations, flush lights lend themselves well to wall use, particularly for lighting stairways or as night lights in hallways. Because none of them drops more than two inches, they make any room appear more spacious and add the modern touch that is often missing from the so-called modern home.



**MODERNIZE YOUR HOME WITH
TRANSLUCENT
PANELS—A NEW
WOVEN-GLASS BUILDING MATERIAL**

By Wayne C. Leckey

IT LOOKS like glass and it feels like glass, and you would think twice about sawing and drilling it like a piece of wood. But the homeowner can do just that in working with a new translucent plastic sheeting that contains some 25 percent glass.

Glasslike, yet shatterproof, this colorful, do-it-yourself building material has unusual structural strength for its seemingly fragile thickness. Being translucent, it lets in an abundance of diffused sunlight, is fire-resistant, and has great decorative value.

Often called "glass-fiber panels," the material consists of polyester resins reinforced with a core of fibrous glass. The result is a lightweight, durable plastic sheeting that can be sawed, drilled, nailed and screwed—all with common hand tools. Originally designed as a roofing material to match the corrugations of sheet metal, the material has found wide usage both inside and outside the home.



PARTITIONS AND SCREENS



AWNINGS AND CANOPIES



GARAGE DOORS AND GATES

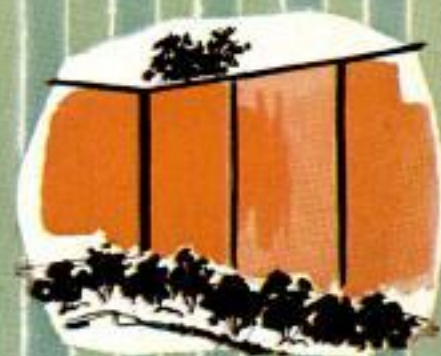

FENCES AND MOVABLE SCREENS



Alayrite Company of America photo

Above, offering amazing structural strength for its seemingly fragile thickness, translucent plastic is extremely lightweight, requiring minimum support

Below, colorful, glasslike translucent panels are ideal for tub and shower-stall enclosures; will not warp or crack and are not affected by heat or cold

Libby-Owens-Ford Glass Co. photo



Where can these translucent panels be used? They can give an open flagstone terrace a "skylight" roof to keep the sun and rain out and let diffused light in so inside rooms are not darkened. The material is perfect for making your own permanent window awnings and door canopies, requiring a minimum of framing. Patio screens which let the light in without sacrificing privacy, and sun-and-wind shelters are among other outdoor uses. If you are planning to build a garage, a panel or two of this translucent material can be used in the roof as a skylight. Full-length "windows" can be installed in the walls of the garage, and it can be used as a facing in making an overhead door. It simplifies the roof

TYPICAL SHAPES AVAILABLE

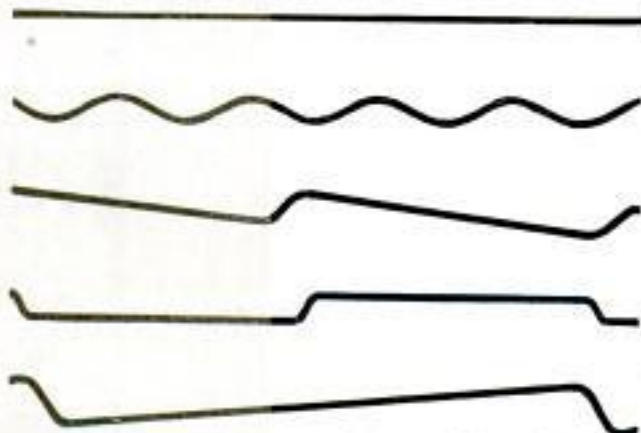

Some Typical Uses for Translucent Plastic Panels

- | | |
|---------------------|-------------------|
| Awnings | Office Partitions |
| Barbecue Walls | Patio Enclosures |
| Bathtub Enclosures | Porch Glazing |
| Breezeways | Quonset Windows |
| Cabanas | Shower Doors |
| Canopies | Shower Stalls |
| Carports | Sidewall Lighting |
| Ceilings | Signs |
| Counter Fronts | Skylighting |
| Display Advertising | Snack Bars |
| Fences | Store Fronts |
| Garage Doors | Sun Shelters |
| Garden Walls | Transoms |
| Greenhouses | Windbreaks |
| Lighting Fixtures | Window Trimming |
| Movable Screens | |
| Neon Signs | |

Right, colorful plastic panels make smart-looking partitions and room dividers for both home and office. Below, curved corrugated panels provide portable sun-and-wind shelter

Akynite Company of America photo





Plymolt Corp. photo

Above, deck covering over patio is popular use for colorful plastic panels due to their translucence. Photos on opposite page show how material is applied to "egg crate" framework in making this installation

Below, attractive basket-weave screen shows what can be done with flat strips of plastic to add privacy to your yard. Plastic is woven in and out among wooden poles spaced vertically in rock-terraced fence

Plexolite Corp. photo



of a carport. On the inside of the house, several panels placed vertically or horizontally in a wooden frame make a smart-looking divider in a combination living and dining room.

The panels have particular value in a home greenhouse, both for their strength and shatterproof qualities, as well as for their optical properties which admit light rays that stimulate plant growth. Set vertically, the panels produce an attractive planter background. Tub enclosures and shower-stall doors are additional uses. Commercially, the material has unlimited applications.

Colors and shapes to be had: Produced by some 16 manufacturers, translucent panels are available in a number of standard and special colors to blend with any color scheme. The panels come in several differ-



Above, V-shaped posts of 2 x 6 which support front corners of "egg crate" roof, are anchored to patio with bolts embedded head-downward in holes drilled in the concrete



Upper right, where necessary, translucent plastic panels are easily cut to size with an ordinary handsaw. Abrasive wheel is recommended when an electric handsaw is used

Right, regular porch roof over this big picture window would darken room. Not so with translucent plastic; it lets the light in. See color transformation on opposite page



Plymold Co. photos

Below left, "egg crate" roof partially covered. Mastic strips are laid between overlapping edges of panels to seal the joints and thus prevent moisture and dust leaks

Below right, "feather light" material permits easy handling. Large 12-ft. sheets, 26 in. wide, weigh approximately 12 lbs. Standard lengths available are 8, 10 and 12 ft.





International Molded Plastics, Inc. photo

Left, tinted panels placed horizontally make smart-looking wall inset that blends well with modern decor



Screw it!



Hammer it!



Saw it!

ent shapes as shown on page 182. These include flat, corrugated, large and small shiplap and board-and-batten patterns. Corrugated is the most widely used as it seems to be the most generally available. In most cases, the flat type is available on special order, as are curved sheets for Quonsets, sunshades and the like. Average thickness of the material is about $\frac{3}{16}$ in., although this varies somewhat among different brands. Extra-heavy, $\frac{7}{32}$ in. thick, is designed for shower doors and bathtub enclosures. As thickness varies, weight does likewise. Average weight of the material is from 7 to 8 oz. per sq. ft. This "feather" lightness permits ease of handling and is especially advantageous where the assistance of the woman of the house might be needed in roofing a carport or a patio shelter. A new woven-texture panel, designed primarily for interior decoration, weighs but 4 oz. per sq. ft.

Standard sizes offered: Translucent plastic panels are sold in 8, 9, 10, 11 and 12-ft. lengths. Some manufacturers also offer them in 4, 5 and 6-ft. lengths. Corrugated panels come in various widths, 24, 26, 30, 36, 40 and 42 in., depending on the particular size of corrugated pattern selected. Corrugations that measure $1\frac{1}{4}$ and $2\frac{1}{2}$ in. wide are more or less standard, although panels of larger corrugations are to be had. Exact measurements vary with the different brands as you will notice in reading the data supplied by the various manufacturers.

Working with translucent plastic: Although they contain glass, some 2 oz. per sq. ft., translucent plastic panels can be cut easily with an ordinary handsaw. However, when using an electric power saw to cut the material, it is recommended that the saw be equipped with an abrasive-type wheel or a metal-cutting blade having fine teeth and no set. Flat-type panels can be cut with ordinary tin shears. A grease pencil is ideal for marking the plastic for cutting. In many cases, installations can

Libbey-Owens-Ford Glass Co. photos



Drill it!



Libbey-Owens-Ford Glass Co. photo

be planned so that no cutting is required. A patio roof, for example, can be designed to make use of standard-length panels.

While a nail can be driven through the material, it is best to drill pilot holes before nailing or screwing the panels in place. In the case of the latter, the holes should be slightly smaller than the screws being used to avoid a slight surface cracking that takes place when the screws are driven home. An ordinary brace and bit can be used to bore the holes if you do not have an electric drill, and it is best to back-up the material while applying pressure with the drill. While home application generally involves fastening the panels to wooden supporting members, the plastic may be bolted to any type material. When using stove bolts, roundheaded screws or nails, a $\frac{3}{4}$ -in.-dia. soft-rubber or Neoprene-gasketed washer is used under the head of the fastener to form a watertight seal. In the case of nailing, a "shock area" approximately $\frac{1}{8}$ in. around the nail hole will occur. This, however, is to be expected and does not harm the material. Whatever type of fastening is used, it should be rustproof—aluminum, galvanized or cadmium plated—to eliminate rust stains on the plastic.

Rafter spacing and cross bracing: In roof framing particularly, correct rafter spacing

Above, new woven-texture panels form an attractive background-wall for indoor planter. Material transmits light freely, but screens vision. Weighs only about 4 oz. per sq. ft.; comes in fine and bold weave

Below, shatterproof translucent panels are ideal for glazing windows of greenhouses and cold frames

Alsynite Company of America photo



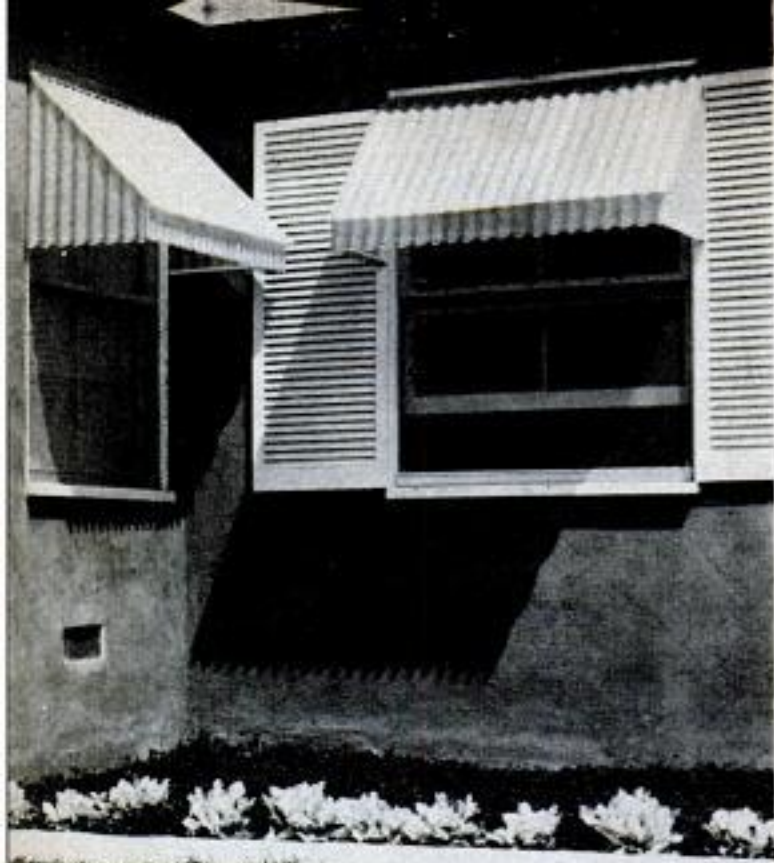

Ripplite Plastic Products, Inc. photo
 Above, colorful and permanent awnings of translucent plastic keep strong sunlight out, let soft light in

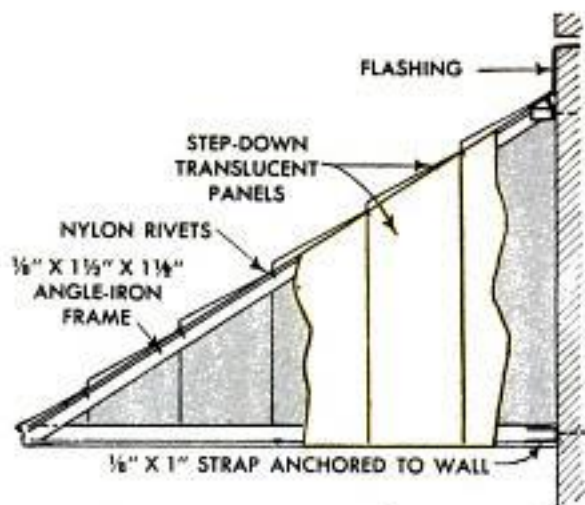

is important to assure adequate nailing support at all seams. A rule of thumb to follow in almost all cases is that the center-to-center spacing of the rafters should be 2 in. less than the width of the plastic sheeting to be used. For example, panels of 26-in. material, having 2½-in. corrugations, must be supported by rafters set 24 in. on centers. No cross bracing is required in the roof framework for 26-in. panels 10 ft. long and under. Where 12-ft. panels are used, cross braces should be added and spaced 6 ft. apart. For 34-in. panels 10 ft. long, the cross bracing should be placed at 5-ft. intervals; 6 ft. for 12-ft. panels.

Typical patio installation: The drawing on the opposite page details construction of the roof framework for a typical patio or carport roof and shows how the plastic sheeting is applied. The over-all size of the framework is determined by the size of the individual panels used. Where the length can be made a multiple of several sheets, cutting is eliminated entirely and the job is greatly simplified. The depth of the framework should be an inch or so less than the length of the panels to provide a drip edge along the front. After the rafters and necessary cross bracing are in place, special corrugated wooden molding is nailed along the front and back edges of



Alpyrite Company of America photos
 Above, flat-type translucent plastic may be used in place of regular frosted glass where vision is not desired. Below, panels of corrugated plastic, 10 or 12 ft. long, simplify construction of a carport roof

Below, built-in skylights that can be nailed in place, are easily installed in corrugated sheet-metal roof
 Libbey-Owens-Ford Glass Co. photo



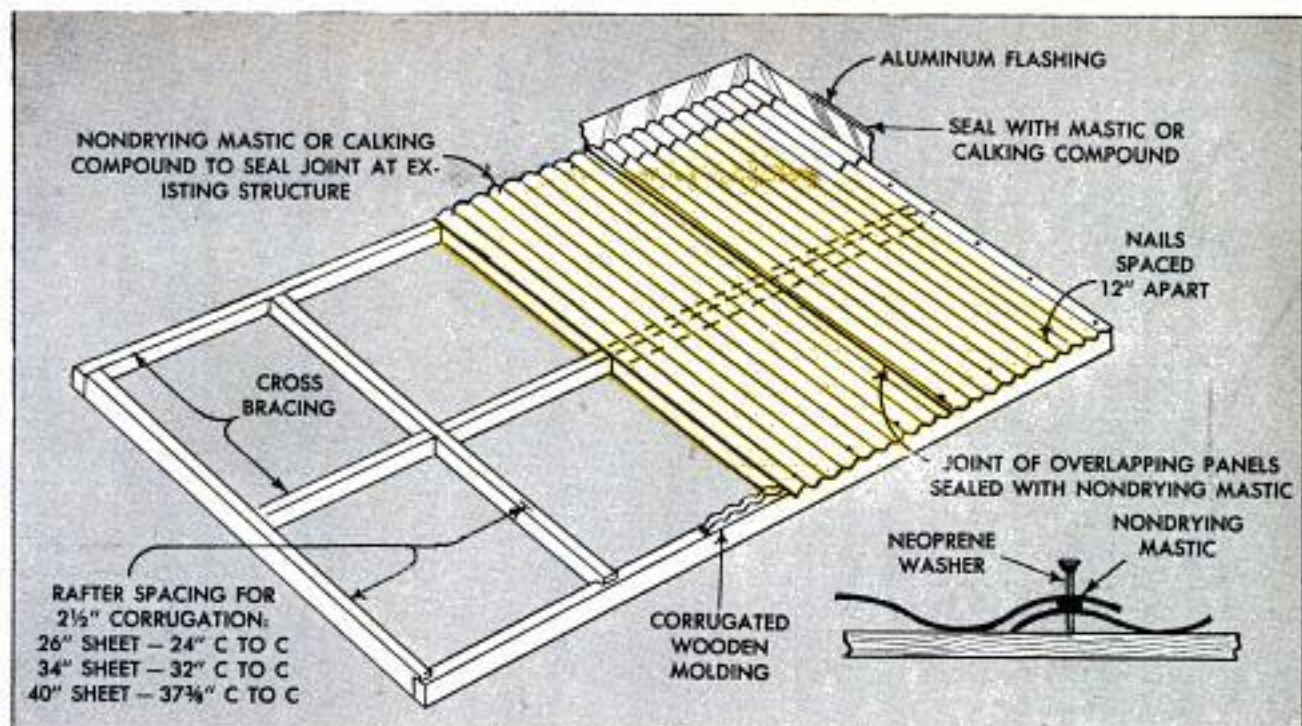

the framework to close the openings formed by the corrugated shape of the panels. The use of the molding can be looked upon as being optional, although it produces a much better job.

Now you are ready to apply the plastic panels. A calking compound or similar mastic is used to seal the roof where it joins the wall of the house. Apply it liberally along the corrugated wooden molding. Each sheet laps the other by one corrugation and to seal these seams, a non-drying mastic is applied to the edge along the full length of the panel. Apply the mastic carefully to assure a positive watertight seal. Next, lay the edge of the adjoining sheet in

the mastic. Special aluminum nails with Neoprene washers under the heads are driven through the crown of the corrugation, through both thicknesses of plastic and into the framework. Nail holes should be predrilled and spaced a minimum of 12 in. In an installation where it is necessary to lap the panels endwise, special mastic strips are laid between the lapped edges. This particular mastic comes in strip form in 20 and 80-ft. rolls. Here the ends of the panels are nailed as before into the cross bracing. Aluminum flashing along with mastic is finally applied so that it laps the plastic panels where the roof joins the wall of the house. ★ ★ ★

Plastic Liner Protects Bottle From Frozen Washer Solution

A broken windshield-washer bottle—caused by an early winter freeze coming before you have time to change to an anti-freeze washer solution—can be prevented by installing a flexible-plastic liner in the jar. Plastic containers, such as are used to store fruit juices in the refrigerators, are obtainable in a number of sizes that will fit inside the washer jar. The container used in the photo measured $4\frac{1}{4}$ in. at the large diameter by $7\frac{3}{8}$ in. high. The lid, of course, was discarded. To prevent the solution from splashing over into the space between the plastic container and the jar, fill the container only about $\frac{3}{4}$ full.

Ben Quan, Ottawa, Ontario, Can.

☐ When the cloth lining in a spectacle case becomes worn, a pipe cleaner may be used to pad the glasses. Just curl the ends of the cleaner and tape it to the bottom of the case.



NEW FACES For Old Homes

By W. Clyde Lamme

BBETTER LIVING need not mean selling the old house and buying or building a new one. Present-day prices and building costs can dim a lot of new-home dreams when you get around to putting the figures down in black and white. Take another good look at the house you live in before you make any decision. Add up the floor area and then compare with present costs for rooms of the same size at \$10 to \$20 a square foot. You may be in for a surprise. It could be, on the basis of this simple calculation, you will decide that while the interior is passably comfortable and livable as it is, the exterior could be a lot easier to look at.

If you buy an old house with an eye to remodeling, the trick in getting your money's worth is to appraise correctly its possibilities beforehand. Take time to study the exterior from grade to ridge line, keeping in mind that on many old homes the removal of the wide cornice alone will materially change its appearance. Mentally take off the front porch or veranda, relocate the front door, remove a dormer or two, visualize a fresh coat of paint and already you have a new house in place of

the old. Now study the "befores" and "afters" below and on the three following pages to see what owners did to change the exteriors of several typical old homes. Note especially the changes made in the full two-story house pictured before and after in the center and upper views on the opposite page. Relocation of the dormer gave better utilization of the attic space and removal of the gable-end cornice overhangs and the installation of drop siding had the effect of widening the structure. Removal of the porch and relocation of the front door, which opens on a concrete stoop, provided for better distribution of living-room space, also served to maintain the balance of architectural details when shutters and side porch were added.

The house pictured in the before view at the lower right and below in the after view presents a somewhat different problem because of its rooms-in-line construction. Again the unattractive porch was removed and the gable extended to house the entryway. The louver fence, masonry planter and a new entryway and door alter the original so completely that it appears to be an entirely new structure.

The four views on pages 192 and 193 picture remodeling jobs carried out by the owners themselves. The two before views show what they started with and a careful study of the larger illustrations will show

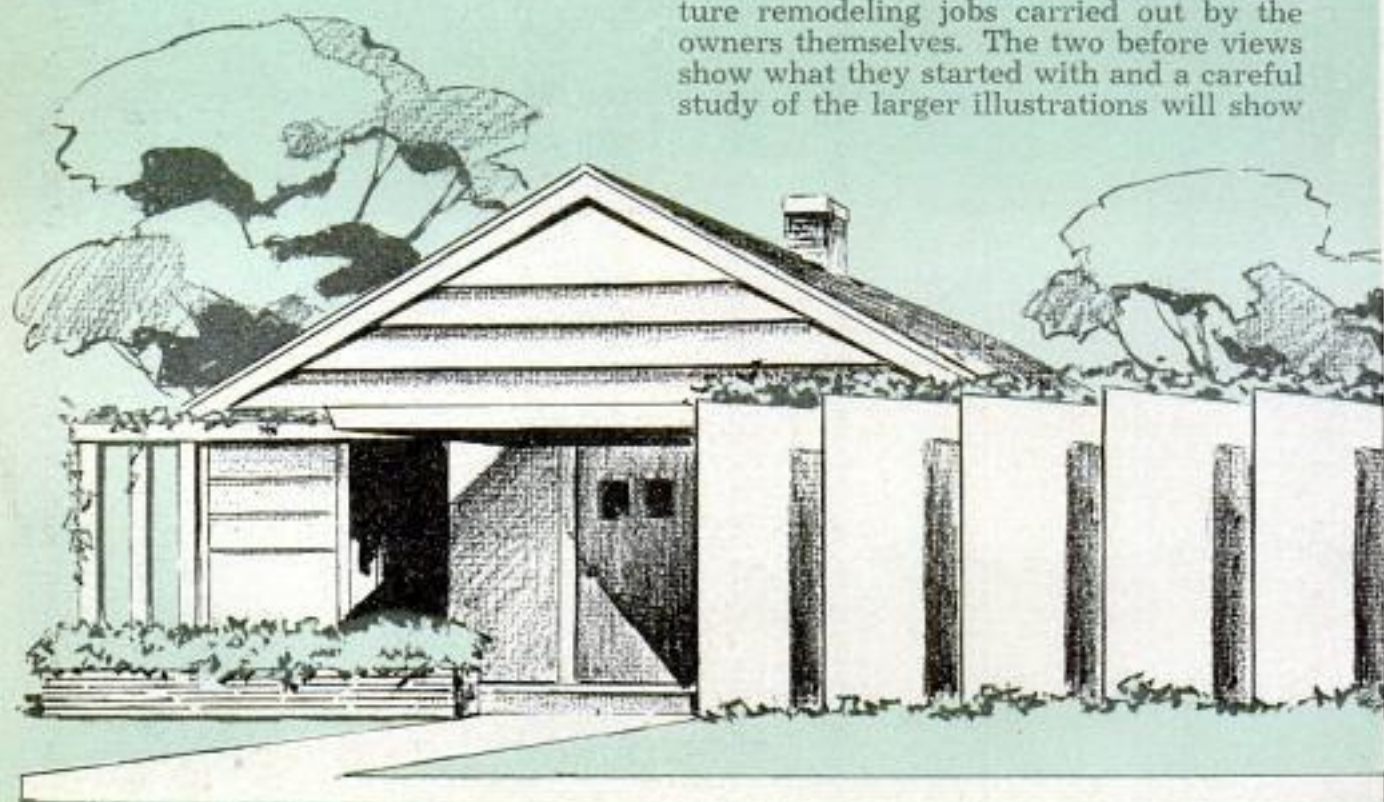

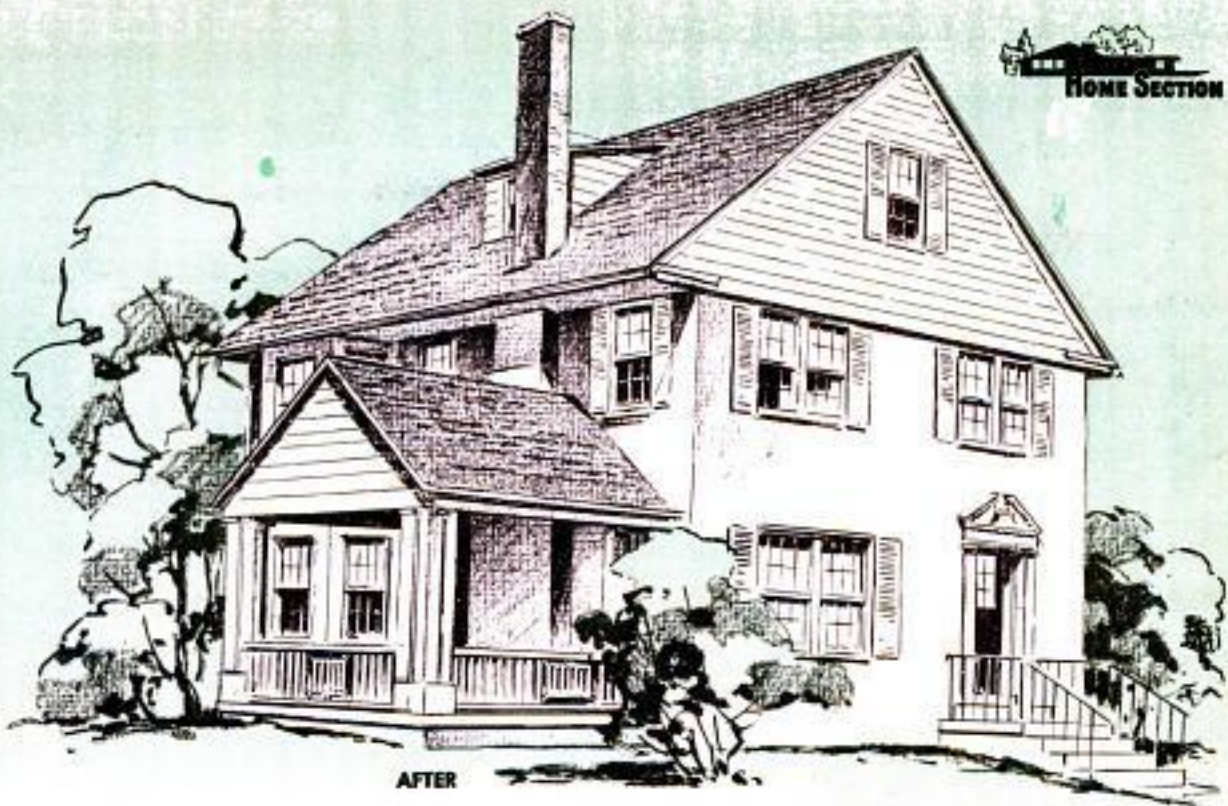

View at the right, center, is the "before" of the old home shown above after remodeling. Compare the two illustrations and note how few structural changes were necessary to modernize the exterior. Relocation of the porch and careful use of drop siding give the effect of lowering the height



Below, right and left, the home pictured in the before view is typical of many built from 40 to 60 years ago. Looks rather unpromising as it stands, but note what the owner did in view at left. Enclosing side yard with a louver fence and remodeling the front changed the house from old to new

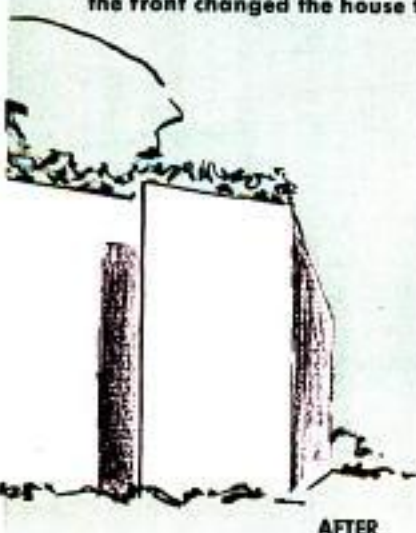

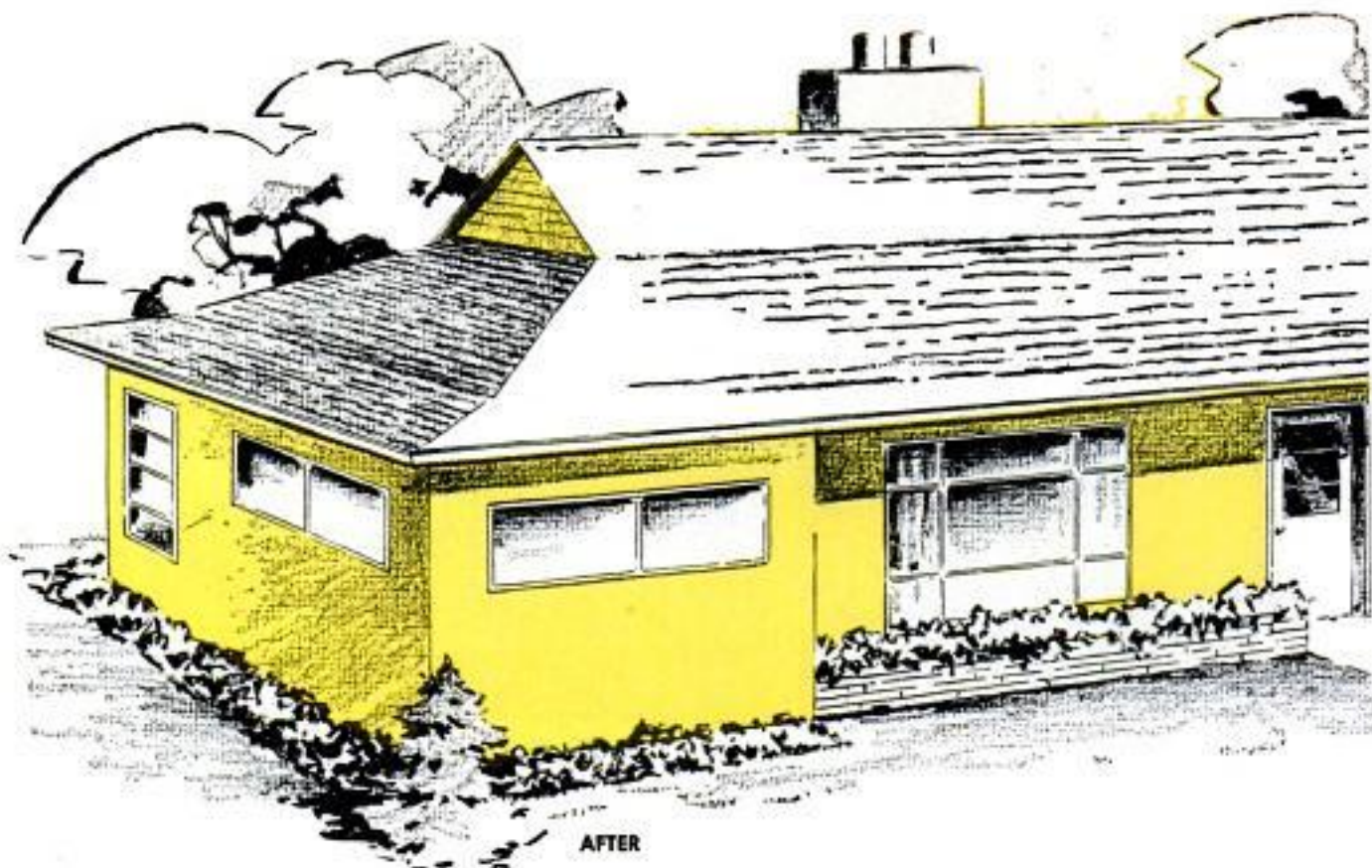

Owners of these two homes, pictured in the before's below, did the work themselves. Owner of the smaller home needed more room and the additions planned and carried to completion are shown in the view above. Many homes of this type will permit similar alterations, creating greater livability and higher valuation



HOME SECTION

how well they succeeded. The owner of the small house needed more room and the upper view shows how he added to the existing structure. The width of the lot permitted expansion of the floor area in both directions but the height of the plate above grade required dual-pitch roof extensions to give the proper ceiling height in the additions. In this job the chimney was rebuilt to provide a second flue for a fireplace in the living room. The house in the lower before view was a very old one, but was found to be sound structurally. Remodeling required very little change in the interior. Because of this the owner concentrated all effort on modernizing the dated exterior. What he did is clearly shown in the larger view below. First, the porch was removed and the garage attached, the flat roof deck over the garage being finished with a plain railing. Then vertical siding was carried across the entire width at the height indicated. The original window openings were enlarged and new sash of modern design installed, including a large panel window in the living room. Then the single dormer and cornices were removed, the latter cut back flush with the walls and finished with fascia boards. An iron-railed concrete stoop and two coats of paint rounded out the job.

All the homes pictured were structurally sound to begin with and did not require any major alteration of the original framing in order to achieve the desired



Lower view, opposite page, is the before of the remodeled home pictured below. No major structural changes were necessary. So the flat-roofed garage was built on and topped with a plain railing. Cornices were removed and vertical siding was applied across the entire front and sides

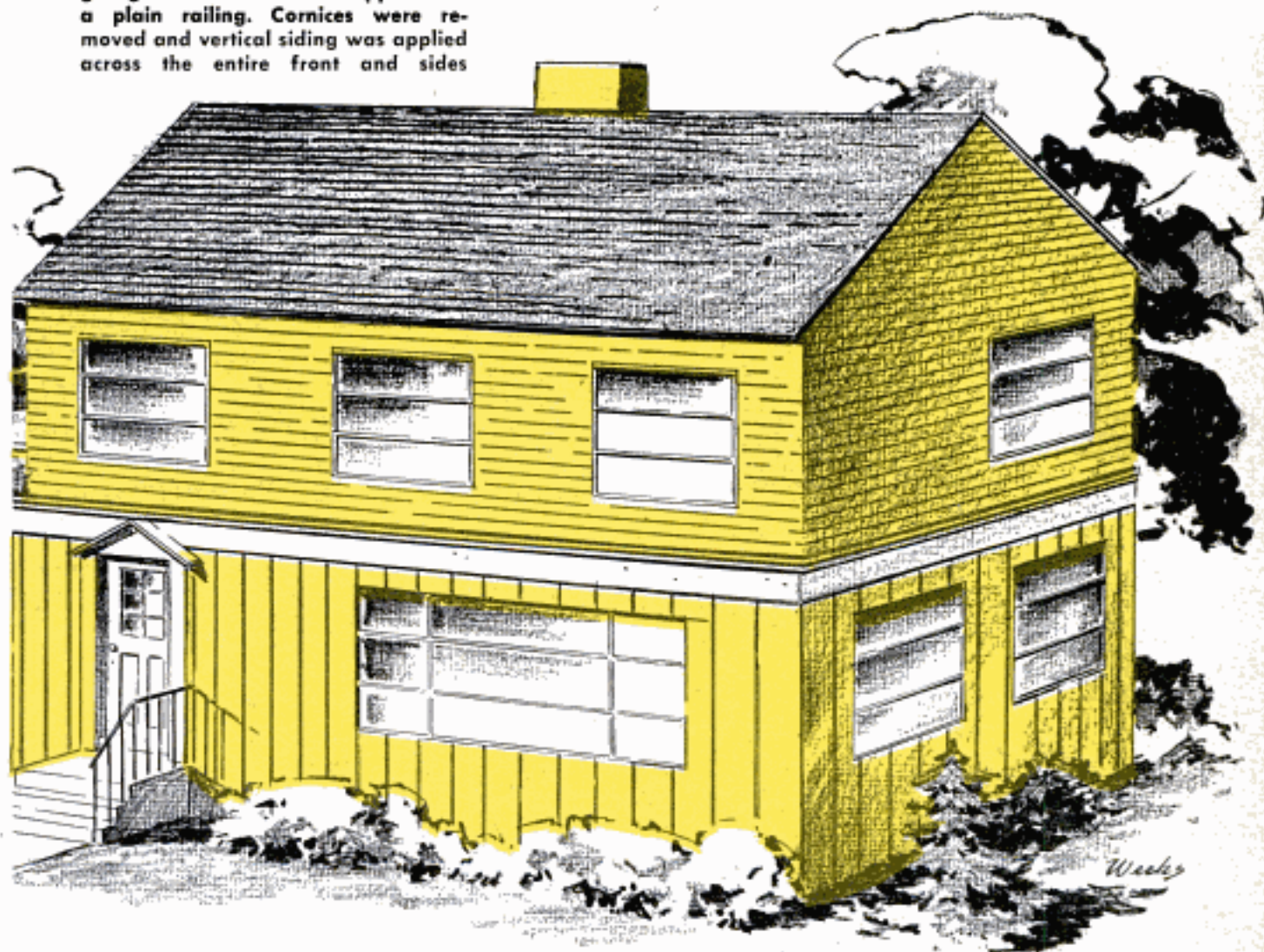



A new front entryway usually is a part of every remodeling job and manufactured units offer a wide choice of design. Shutters add pleasing detail



A recessed doorway has several advantages. Door itself is protected from weathering, it is less likely to leak and there are added decorative possibilities

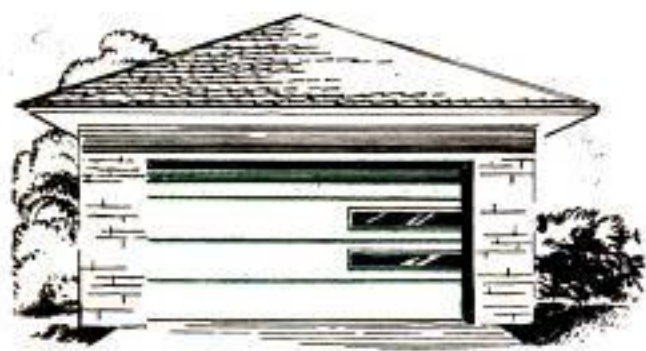

A modern door makes an old garage look new. These units are available ready-made in several styles which can be adapted to almost any building type



Due to variations in architectural lines a garage with a gable roof usually appears its best when fitted with a multiple-panel door of the type pictured



Above, a woven closure for "weather" end of carport added a pleasing appearance detail to this small home. Below, utilization of carport as a living area

result. These are points to consider in any remodeling job.

The suggestions on this page are unit improvements that can be added to old or new homes. Garage and entry doors are manufactured units and come to you ready to install. The sketch at the left shows how one owner closed the "weather" side of the carport with closures woven from hardboard strips. The two sketches below show the addition of carports to existing small homes. ★ ★ ★

When lot size permits, a carport is a practical addition to the small home. Has a definite appearance value. Note below how carport lengthens roof line



the

POPULAR
MECHANICS

CRAFTSMAN



FREE-FORM TABLE OF CORK

By Tom Riley

YOU CAN give your home a touch as modern as tomorrow and as individual as yourself by designing your own free-form tables. Whether you plan an occasional table to fit some corner, an end table or a coffee table, you'll find the construction easy and the results attractive.

As shown in the example, the table can have free-form curves of any radius down to 2½ in. without complications. Standard cork floor tile is used to cover the top and edges, giving a rich appearance and producing a surface that is immune to scratching and to rings from moist glasses. The cork requires only a coat of wax as a finish. It is available at floor-covering stores in several tile sizes and in shades from dark to very light brown.

First experiment with various shapes on a small piece of squared paper, until you

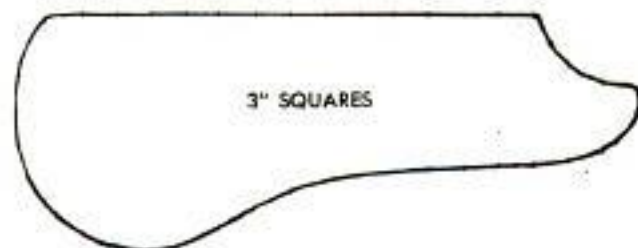

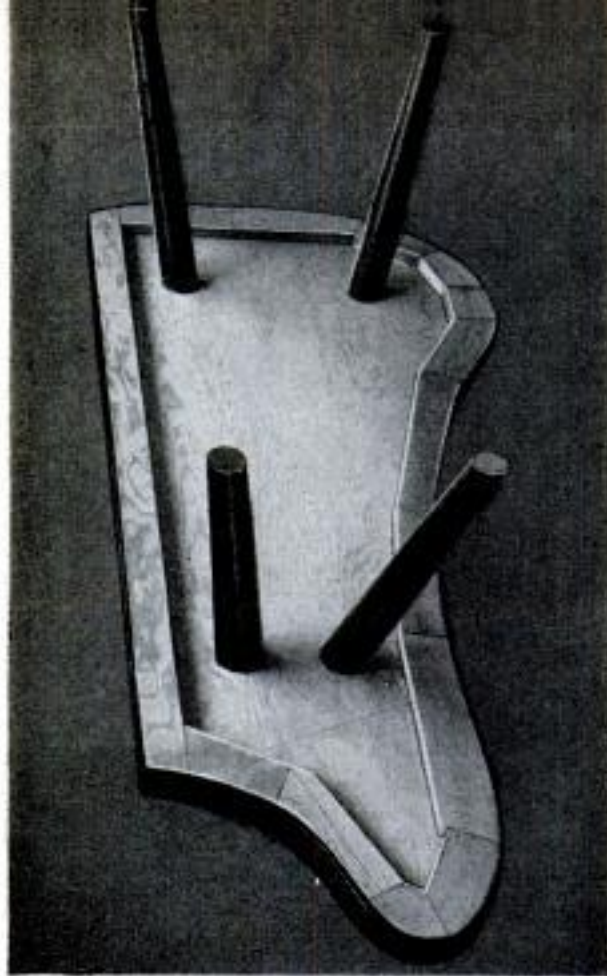

Above, underside view of table, showing how edges are built up from scraps. Below, after cork is applied to edges, it is held in place with masking tape

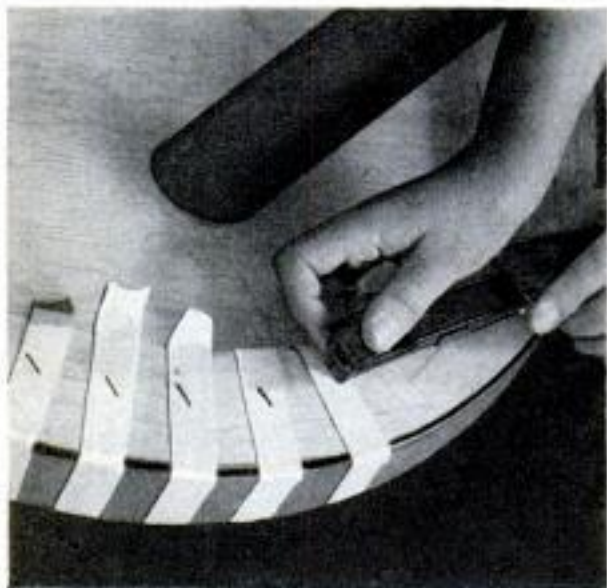

are satisfied with the shape. Then transfer the final design to a squared-off sheet of heavy paper, bringing it up to full size as you do so. Using this pattern, cut the top from $\frac{3}{4}$ -in. plywood. To build up the thickness of the edge, scraps of plywood or $\frac{3}{4}$ x 3-in. pine are glued and nailed along the underside of the edge, and then the double thickness is sanded smooth.

The legs can be of dark walnut, light birch or of wrought iron. The wooden legs are turned on a lathe to a pleasing taper and then secured to the top with glue and large screws. Drill the screw holes straight down, as shown, so that the legs can be pivoted for alignment with each other. The legs can be varnished before assembly or rub-finished on the lathe with linseed oil.

Tile $\frac{3}{16}$ in. thick should be used for bending sharp curves; otherwise, $\frac{1}{4}$ -in. tile is best. To bend around a sharp curve without breaking, heat the underside of the tile with an electric pressing iron until it is hot to the touch. Select flush, square-edged tile, not beveled, and use a straightedge and a sharp knife for cutting. Place the cork around the edges first, cutting strips $\frac{1}{4}$ in. wider than needed. Coat each strip with glue and then secure it in place with masking tape. It is best to anchor the masking tape with a tack or staple at each end.

The cement used to apply cork tile to walls is suitable, as is any good furniture glue. Linoleum cement should not be used, because it takes several days to dry, and is hard to work with.

Allow a day for the edges to dry, then trim them top and bottom with a sharp knife. Then sand smooth with coarse and fine sandpaper. Next apply glue liberally over the table top and lay the tiles in place. They should extend over the edge all around. Weight them down with sand bags or books until dry, then trim carefully and sand smooth. Finish the top with a coat of paste floor wax. If the top should be nicked at any time, the hole can be filled with a mixture of paste wax and dust obtained from sanding a scrap of cork. ★ ★ ★

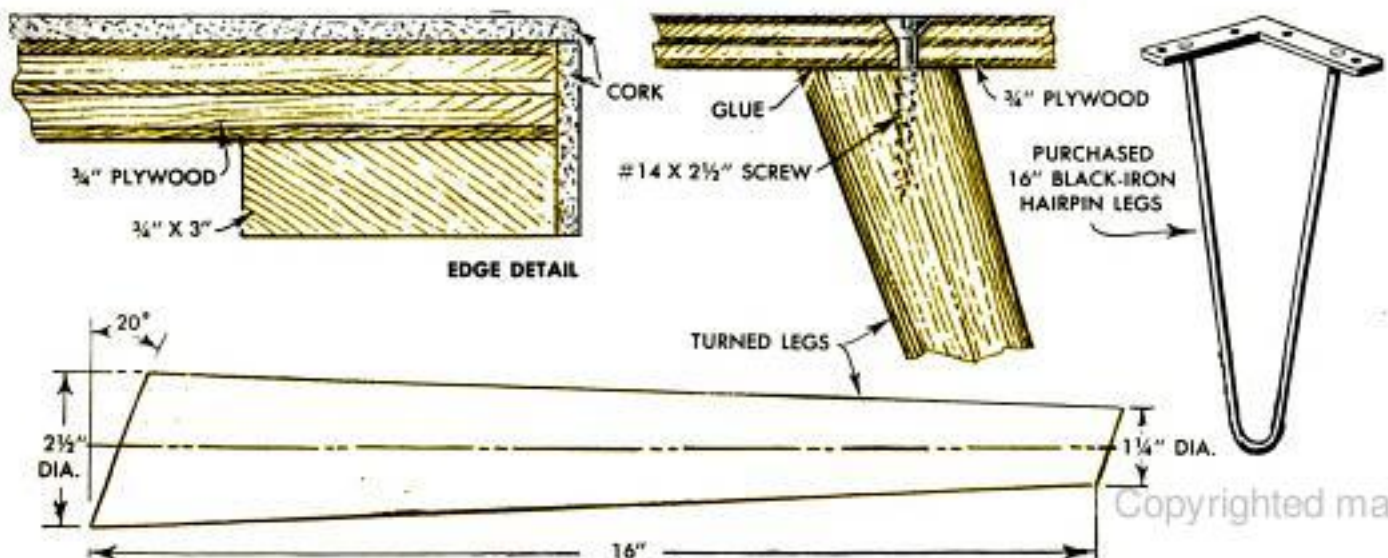

Doorstops Hold Drawing Board In Tilted Position

Screwed into the underside of a drawing board, two rubber-tipped doorstops support it in a tilted position on a table or desk. Check the desired angle of the board before attaching the stops.

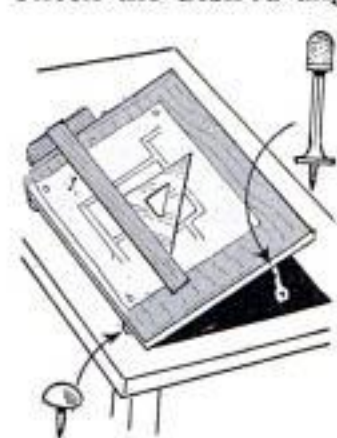

If desired, drive a couple of rubber-headed tacks into the lower edge of the board. In this way, the board will be supported entirely on rubber to avoid marring highly finished surfaces. — Norm Jacky, Fond du Lac, Wis.

Wash Surface With Turpentine After Using Paint Remover

After paint has been cleaned from a surface with paint-remover solution, the surface should be thoroughly washed with turpentine and then wiped dry with clean cloths. This is done because most paint and varnish removers contain wax, some of which is deposited on the cleaned surface, and paint will not dry properly on waxed surface.

Multipurpose Tool for Darkroom Provided by Wiper Blade



A soft windshield-wiper blade provides an excellent tool of many uses for the darkroom. It can be used as a squeegee for wiping roll film hung on clips, as shown in the illustration, and for wiping cut film placed on a sheet of clean glass. The wiper blade also can be used to clean the glass on the contact printer and to remove the

excess water from ferrotype plates. Because of its softness, the blade does a better job than a roller, to squeegee prints onto a ferrotype plate. Also, since the blade can be purchased in a length that will cover the entire print in one stroke, better contact with the tin is assured.

Robert C. Florian, Chicago.



Leather Sheath Covers Exposed Blade of Ax

To eliminate the chance of accidentally being injured by the naked cutting edge of your ax when carrying it in your pack, boat or car, make a sheath for the blade as shown. Using heavy leather, lay out the two sides to fit the size and shape of the ax head. Then join the pieces with copper rivets of the type used in leatherwork. The strap and buckle, which can be obtained from an old piece of luggage or briefcase, are riveted in the same manner.

Russ Jenkins, Chicago.

Angle Cut on Ornamental Molding Provides Guide Line for Coping

When fitting an ornamental molding or coping into a corner, it usually is difficult to make the irregularly curved surfaces meet exactly to form a neat corner. One easy way of doing it is to make a 45-deg. cut across the end of the molding, as shown, and then use the resulting profile as a guide line along which to cut with a coping saw. The coped piece will then butt perfectly at right angles to another section of the molding.—R. F. Donovan, Guttenberg, N. J.

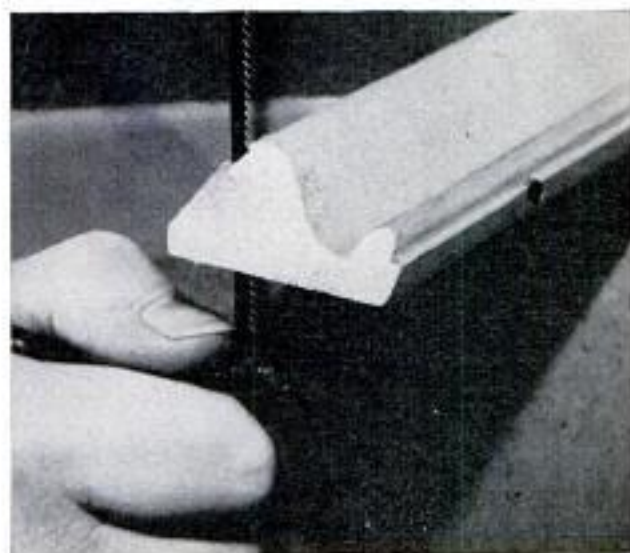

Bookshelf Modified for Magazines Neatly Stores Back Copies



Modifying a bookshelf to fit the size of a favorite magazine will enable you to store periodicals in such a way that any back copy can be picked out. The shelves should be fitted with vertical partitions so that only a limited number of magazines are in each section. Thus, the removal of one magazine will not cause the others on the shelf to topple over.

Richard Lepley, Norwood, Ohio.

Washer Held in Hose Connection By Long Straight Pin



A long straight pin or a length of fine wire can be used to overcome the difficulty of keeping washers in hose connections that are disconnected. The pin from which the head is removed,

or the fine wire, is forced through the edge of the washer and allowed to project on both sides. The projections permit the washer to be "threaded" into the hose connection, thus locking it in place.

William B. Eagan, Louisville, Ky.

Fish "Weighed" With Tape Measure

Fishermen can get an accurate approximation of the weight of their catch with a tape measure. First, measure the circum-

ference of the fish, in inches, at its largest girth. Square this number and multiply by the length in inches. The latter measurement is taken from the fork of the tail to the end of the head. Divide the result by 800 to get a good estimate of the fish's weight.

Electrical-Appliance Cord Coiled To Keep It Off Floor

Instead of letting the long electric cord of a lamp, radio or other appliance lie on the floor where it is unsightly and may cause someone to trip, twist part of it to form a coil. This will shorten the cord and lift it from the floor, yet permit using the



full length whenever necessary. To form the coil, wrap the cord around a pencil or small dowel until the cord is the correct length.

Rubber Cemented to Chinaware Protects Furniture Finish

Rubber rings used to seal fruit jars are ideal for the bottoms of ash trays, vases, figurines and other chinaware and pottery objects that might damage the finish of furniture. Rubber has the advantage over felt, ordinarily used, in that it does not absorb water when the object to which it is attached is washed. Also, the rubber cement used to attach the rubber to the object does not dissolve in water, as do some adhesives used to attach felt.



☐ To stop ants from entering your home, place cucumber peelings around the door, along the molding or at any other point where they might enter.

Valuable Uses For Blackboard Erasers

By James Ship

The common blackboard eraser has many extra uses, such as the one at the right, where it is being used to apply pumice during furniture refinishing. This makes it easy to get a professional hand-rubbed look

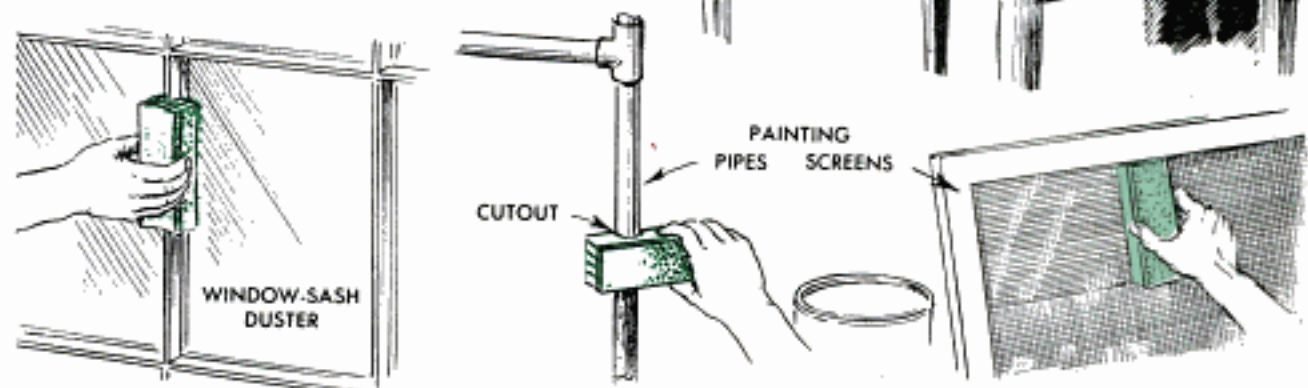
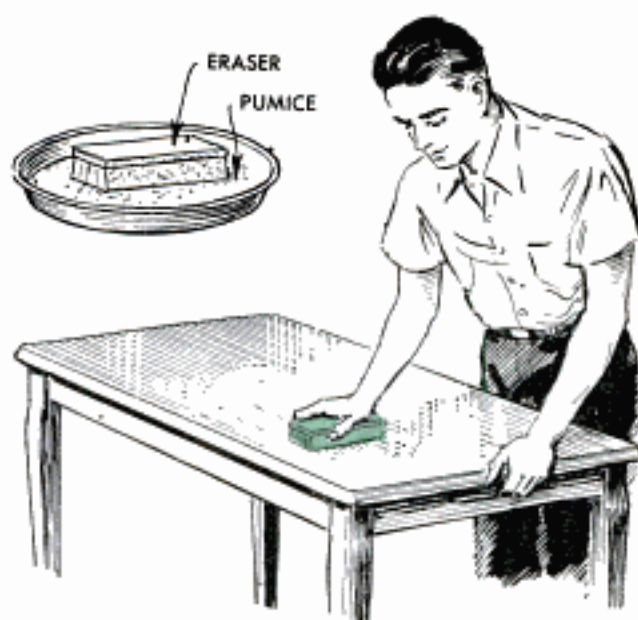

A housewife can save time and do a better dusting job by using an eraser to dust window-sash dividers

At those times when a paintbrush won't do the job, as when painting screens or pipe, use an eraser

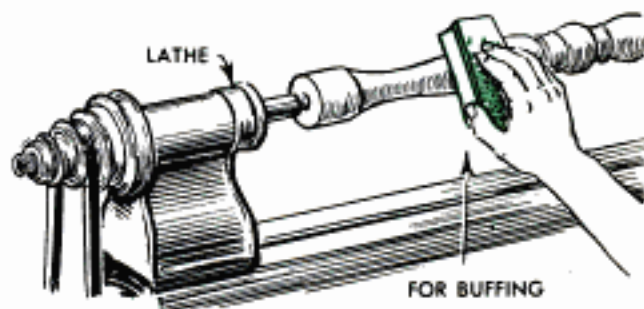
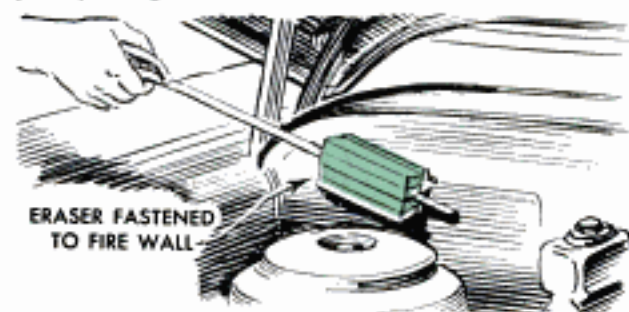

Mounted on the fire wall of an automobile by means of two screws, the eraser becomes a permanent oil-stick wiper. Simply draw the stick through the folds

After making a turning on a lathe, you will find the eraser an excellent tool for buffing and polishing to a professional finish. Keep several in the shop

Portable typewriters usually are fastened to the lid of the case and used right in it. To silence noise from the machine, install an eraser under each corner

Screwed to the bottom of a kitchen or workbench drawer, an eraser will provide ideal storage for odds and ends such as thumbtacks, paper clips, etc.

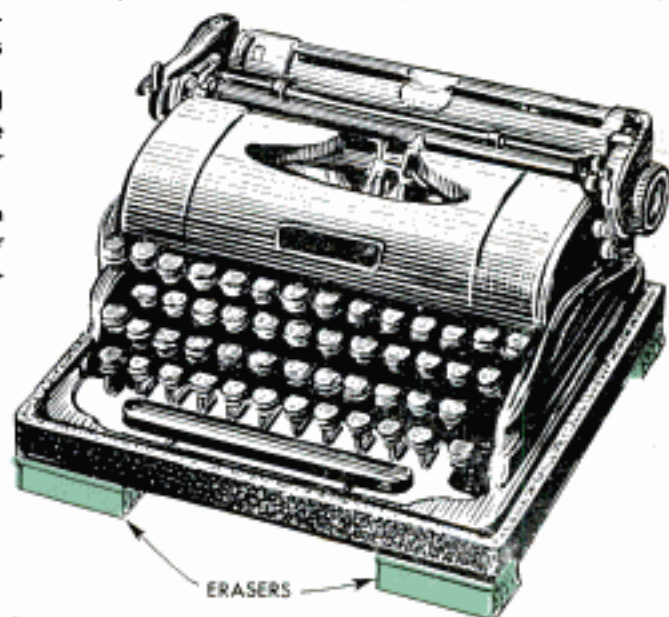
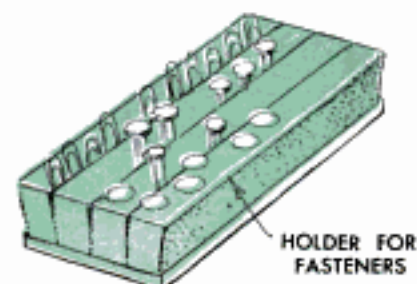



Risers on Basement Stairs Help Keep Floor Clean

Troubled with dirt dropping below the basement stairs when they were swept, one homeowner nailed on pieces of hardboard as risers. The risers are fastened at the top of each step to lengths of quarter-round molding nailed to the underside of the treads. As the treads overlap a distance sufficient for "kick space," no trouble was experienced from the risers loosening.

Inexpensive Lumberyard Molding Used for Picture Framing

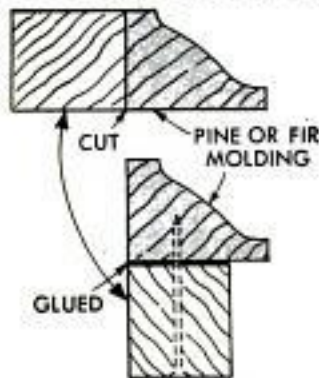

Attractive picture-frame stock can be made by ripping inexpensive fir or pine window-stop molding along the milled edge. As shown in the detail, the milled edge is cut away from the plain portion of the stock

which is then nailed and glued to the back to form a rabbet for the glass and picture.

Edward E. Thorp, Montclair, N. J.

Preheated Ferrotypes Plates Reduce Print-Drying Time

Faster print drying with an electric drier — single or double — can be accomplished by preheating the ferrotypes plates. An extra plate or plates are used, and while one set of prints is in the drier, the extra tin is placed beneath the drier where it absorbs the waste heat. When the set of prints in the drier is finished, the preheated tins

are used for the next set. Because they require less heat, they will, of course, require less time in the drier.

Hugh Lineback, Stillwater, Okla.

Nail and Cork Over Clock Face Provide Emergency Timer

An emergency timer, for photo or other work which requires less than an hour's time, can be made by forcing a nail through a cork and holding this assembly over the center of the face of an alarm clock with a rubber band and thumbtack. In use,

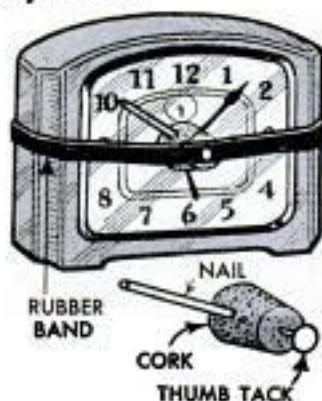

the pointer of the "timer" is set at a predetermined time and when the minute hand of the clock coincides with the pointer, the proper time has elapsed.

Cut Waste by Puncturing Lemon

To prevent waste when only a few drops of lemon juice are required by a recipe, puncture the end of the lemon with a fork and squeeze out the required amount. Thus treated, the lemon may be kept in the refrigerator without spoiling or drying out, and can be used later.

D. Fenn, Chicago.

Chalk Line Stretched With Bow Permits Accurate Marking

A chalk line strung on a bow will permit quick and accurate marking of flat stock for rough cuts. The ends of the bow are pointed to be in alignment with the cord; thus making it possible to accurately locate the cord on measurement marks. The cord is not subject to warping, as is a wooden straightedge and so can be stored in any convenient location.

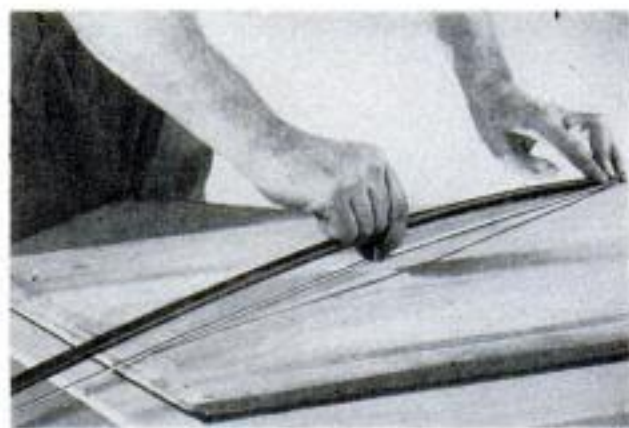

WTM 56

Brass Trivet

An attractive trivet that will protect the dining-room table from hot dishes, the teapot, etc., is easy to make and adds a fine touch to a table set for a dinner party. The six feet of the trivet are brass lamp finials turned into tapped holes in the frame, the latter being cut from 1/8-in. sheet brass. The trivet pictured is 7 in. across, but the size can be varied to suit your particular requirements

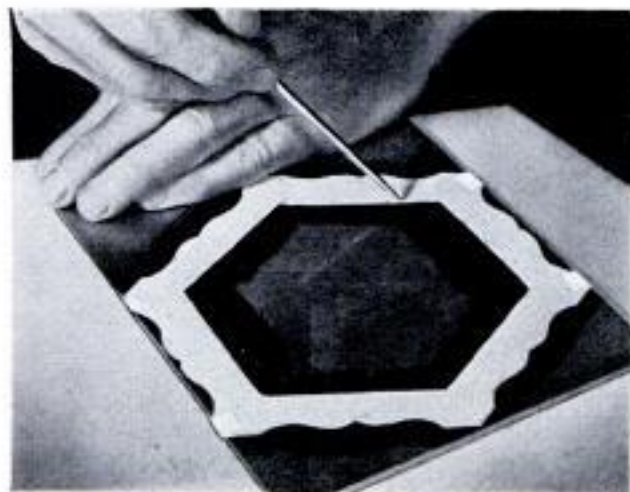
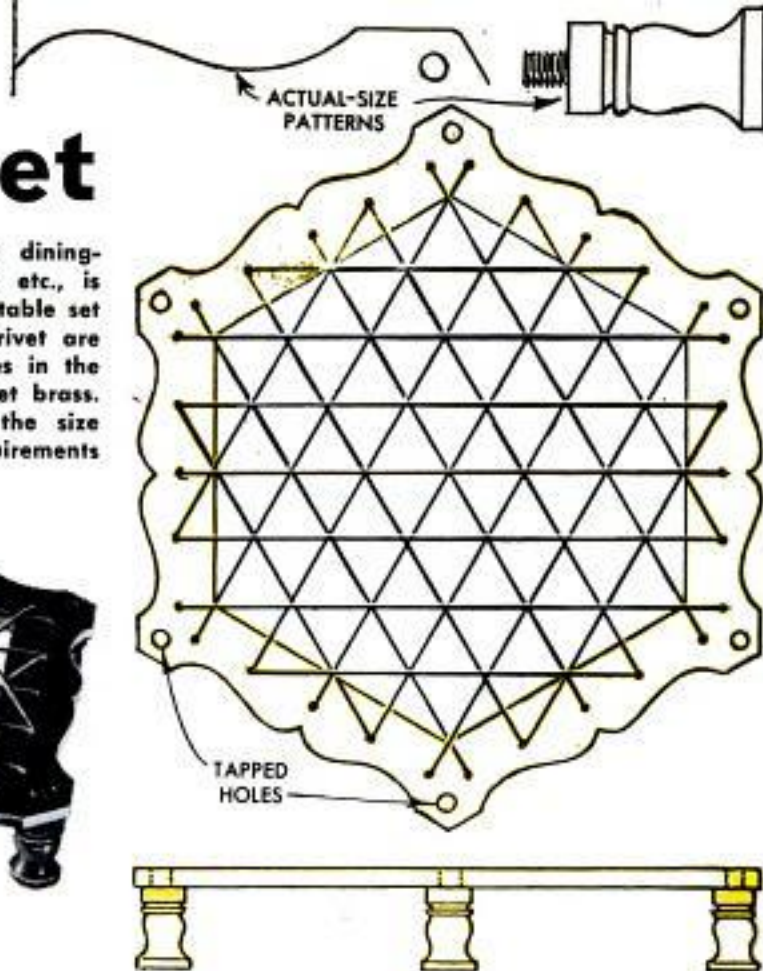

Above, brass is painted with India ink and the outline of the trivet frame is scribed on the brass, using a cardboard template. Holes for the finials are center-punched, drilled and then tapped, as below



The frame is cut out on a jigsaw, above, using a fine-toothed blade. Below, the frame is set in a vise and strung with wire. To finish the assembled trivet, polish with fine steel wool and coat with lacquer

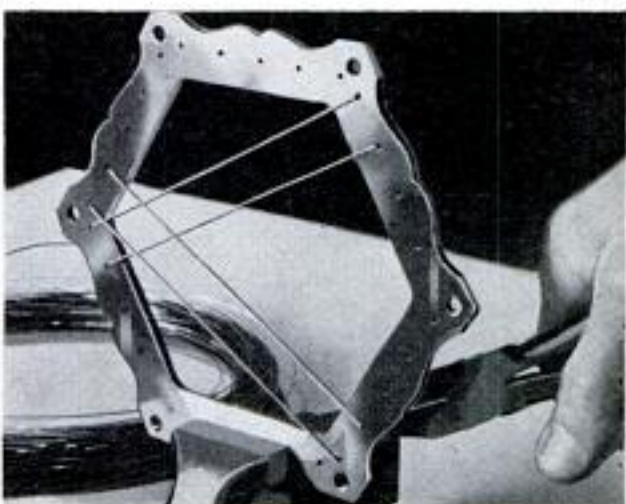
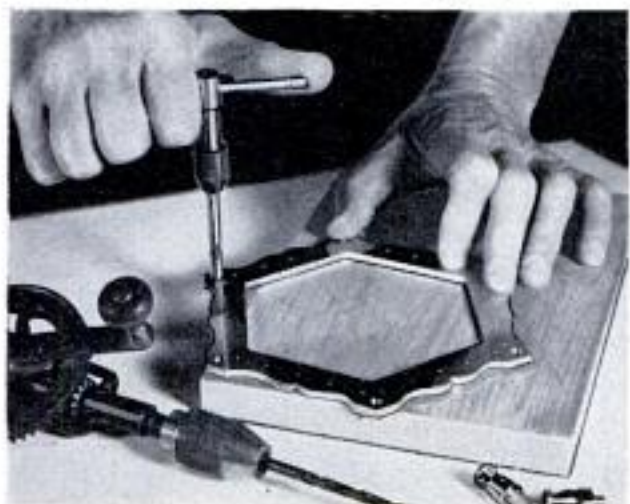

Solving

HOME PROBLEMS . . .



HOUSE PLANTS WILL NOT BE DAMAGED from too much water if pots are placed in coffee cans packed with sphagnum moss. Moss absorbs excess water, keeps pots cool



A SAMPLE OF YARN to be matched can be carried in a handbag, unsoiled and not easily mislaid, by fastening it inside cover of a matchbook with cellulose tape



SCRATCHES IN FINISH of walnut furniture are made invisible by rubbing them vigorously with the cut surface of a freshly sliced walnut or Brazil nut

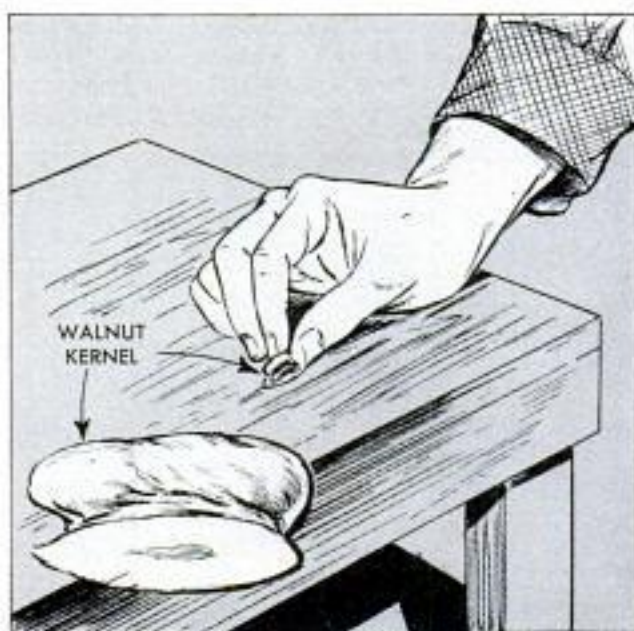

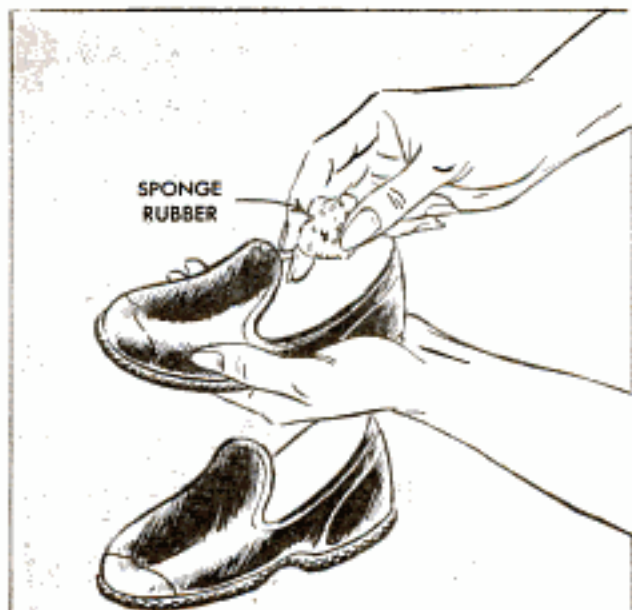

A CHILD'S OVERSIZE RUBBER can be fitted snugly by inserting sponge rubber in the toe. The sponge rubber will not pack into uncomfortable wad as will paper

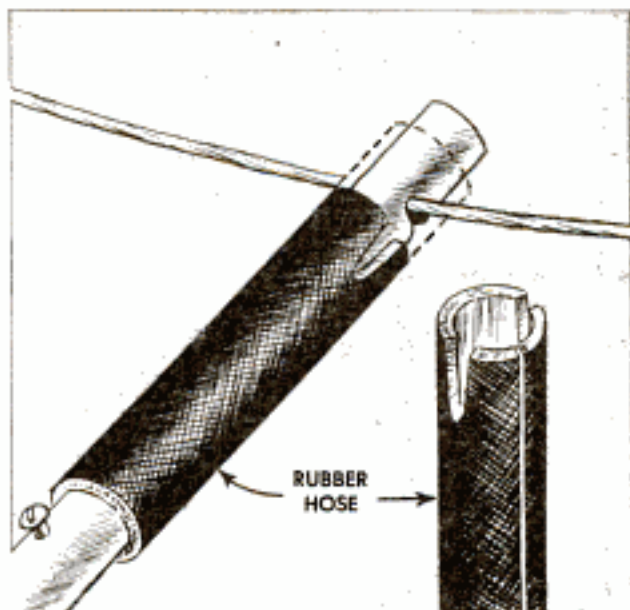

CLOTHES POLES WILL NOT SLIP on line if fitted with sections of hose notched as in detail. The line fits in groove cut in side of pole and is held by hose

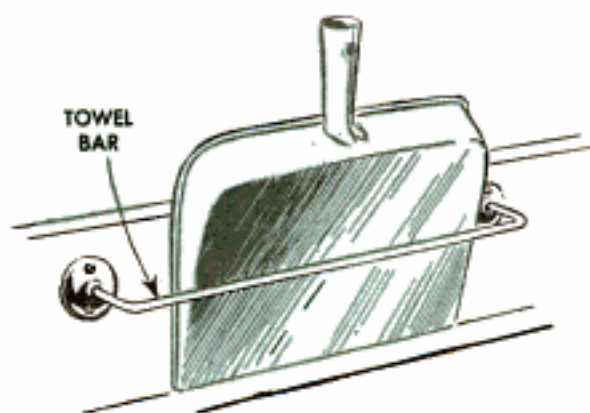

SCREWED TO THE BASEBOARD at a convenient spot in the kitchen or broom closet, an ordinary towel bar can be used to provide a handy rack for storing a dustpan

GARBAGE CAN IS ANCHORED by driving pipe into ground so it passes through handle. A $\frac{1}{4}$ -in. steel rod, bent as shown and slipped into pipe, will hold lid

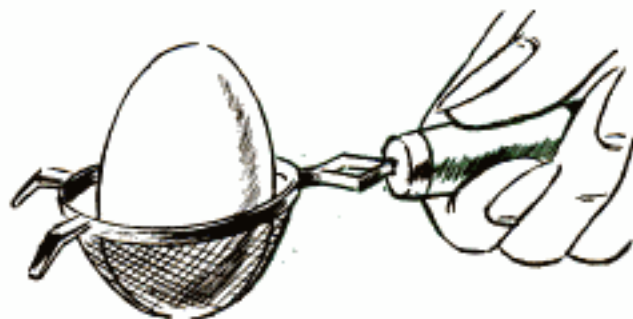
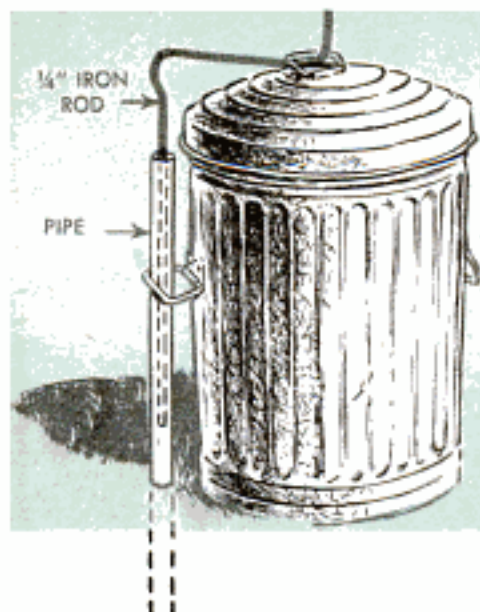

IF NO HOT-FOOD TONGS ARE AVAILABLE, hard or soft-boiled eggs can be removed from pan of hot water in which they are cooked by using a tea strainer. The strainer permits eggs to drain dry quickly and will not crush the shells as will some tongs

FATIGUE AND DISCOMFORT caused by weight of blankets on the feet of person in bed can be relieved by using frame of $\frac{1}{4}$ -in. rod. Bend as shown in detail

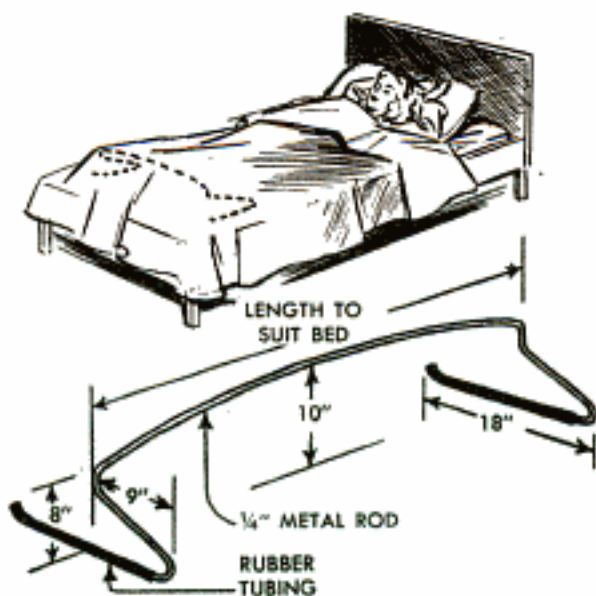

Guards Protect Wood Surface Against Screwdriver Damage

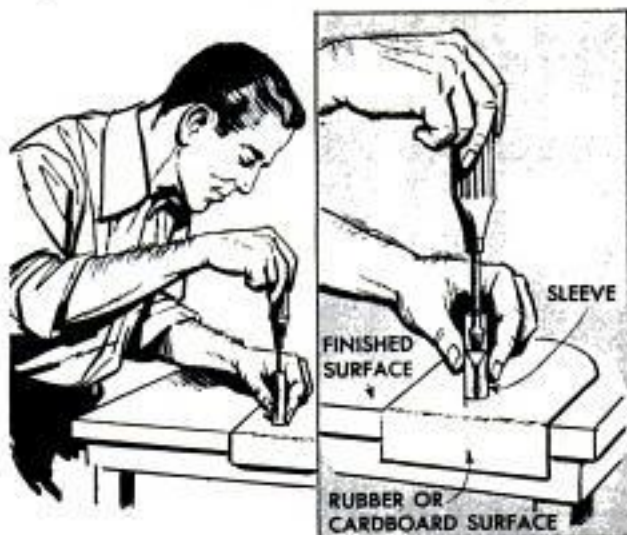

Two simple guards will prevent the damage to a finished wood surface caused by a screwdriver slipping off a screwhead. First, use a sleeve, such as a length of pipe or tubing, in which both screw and driver will fit without binding. Next, place a shield made of rubber or heavy cardboard over the wood surface. Cut a hole in the shield, slightly larger than the screwhead, but smaller than the sleeve. A combination-type drill should be used, or a pilot and shank hole drilled, to receive the screw.

Powder Puff Chucked in Drill Utilized as Buffing Wheel



The next time you need a small buffing wheel for cleaning jewelry, silverware or other articles with a figure or pattern that requires a high polish, use an ordinary powder puff chucked in a $\frac{1}{4}$ -in. portable drill. Punch a hole in the center of the puff and slip it on an "arbor" made

from two washers and a nut fitted on a machine screw, as shown in the detail.

John W. Sherman, Mountain View, Calif.

Extra Blades for Carving Tools From Injector-Razor Blades

Modelmakers will find that discarded injector-razor blades can easily be made into replacement blades for carving tools. After grinding a blade to the shape desired, hone

the cutting edge on a fine oilstone. Care must be taken, however, not to overheat the blade, since this will draw the temper.

John A. Comstock, Wellsboro, Pa.

Rubber Boots Dried Quickly With Aid of Hardware Cloth

Drying wet rubber boots can be hastened by holding the tops of the boots open with a piece of hardware cloth. The cloth is formed into cylinders and one is placed in the top of each boot, thus permitting circulation of air.—Howard E. Moody, Upper Jay, N. Y.



Heat Restores Ball-Point Pen

After remaining unused for some time, ball-point pens may become inoperative. When this happens, the pen usually can be restored to usefulness by heating the point slightly with a match, or by immersing it in hot water. Bring the water to a boil, remove it from the stove and then submerge the point for about ten minutes.

Spencer A. Pease, Wauwatosa, Wis.

Round Typewriter Eraser Provides Abrasive Disk

A rubber abrasive wheel for cleaning and polishing small items can be made quickly by mounting a round typewriter eraser on an arbor for use in a small high-speed hand grinder. Place a small lock washer on the arbor shaft to prevent the wheel from working loose while in use.—Pvt. Philip E. McCafferty, Fort Bliss, Tex.



Lamp for Vanity Table Also Serves as Night Light

Here is a chimney lamp with a dual purpose, since it serves as an attractive vanity lamp and also provides a soft night light. The base is a wooden bowl 9 in. in dia., from which the wax coating is removed with sandpaper. Holes are drilled for the wiring and switch and a plastic ring to support the shade is screwed in place. As shown, a double receptacle is modified to permit use of 40 and 7½-watt lamps. The shade is made of a 10½ x 15½-in. piece of Fiberglass lampshade material. This is formed into a cylinder, with the overlapping edges glued. A plastic ring cemented into the top of the shade maintains the shape. If two of the lamps are used together, only one is wired for the night light.—R. L. Oldenburg, Levittown, N. Y.

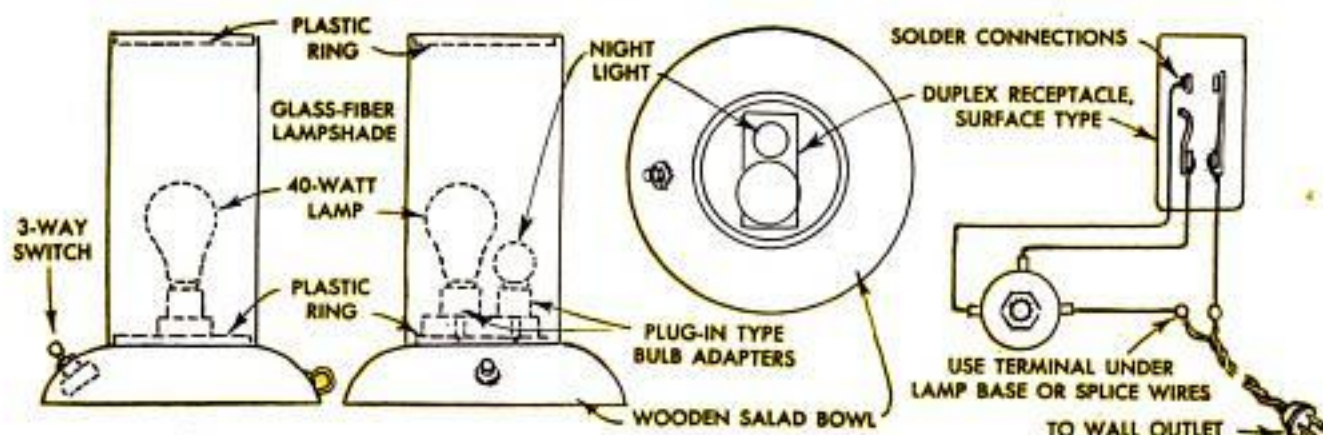

Doghouse Built Under Workbench Heated by Light Bulb

By enclosing the lower part of your workbench it will provide an excellent house for your dog. Sufficient heat to keep the dampness at a minimum and allow the dog to be

comfortable is provided by an electric-light bulb on the underside of the bench top. The bulb is fitted with a reflector as shown in the detail. The window which encloses the bench shown was used because it happened to be available, but the sides of the house could be made of any material at hand. The door opening can be hung with burlap. Bruce C. Vaughan, Jr., Springdale, Ark.



Salt and Pepper Shakers for Picnics

Individual salt and pepper shakers, handy for traveling and for picnics, can be made from dental-floss containers. Turn back the metal hook on the top of the container and punch five to seven additional holes in it. After the containers are filled, place a paper or cork disk under the cap to prevent spilling while in transit. Remove this disk and the little shaker is ready for use.—Helen Lemberger, Chicago.

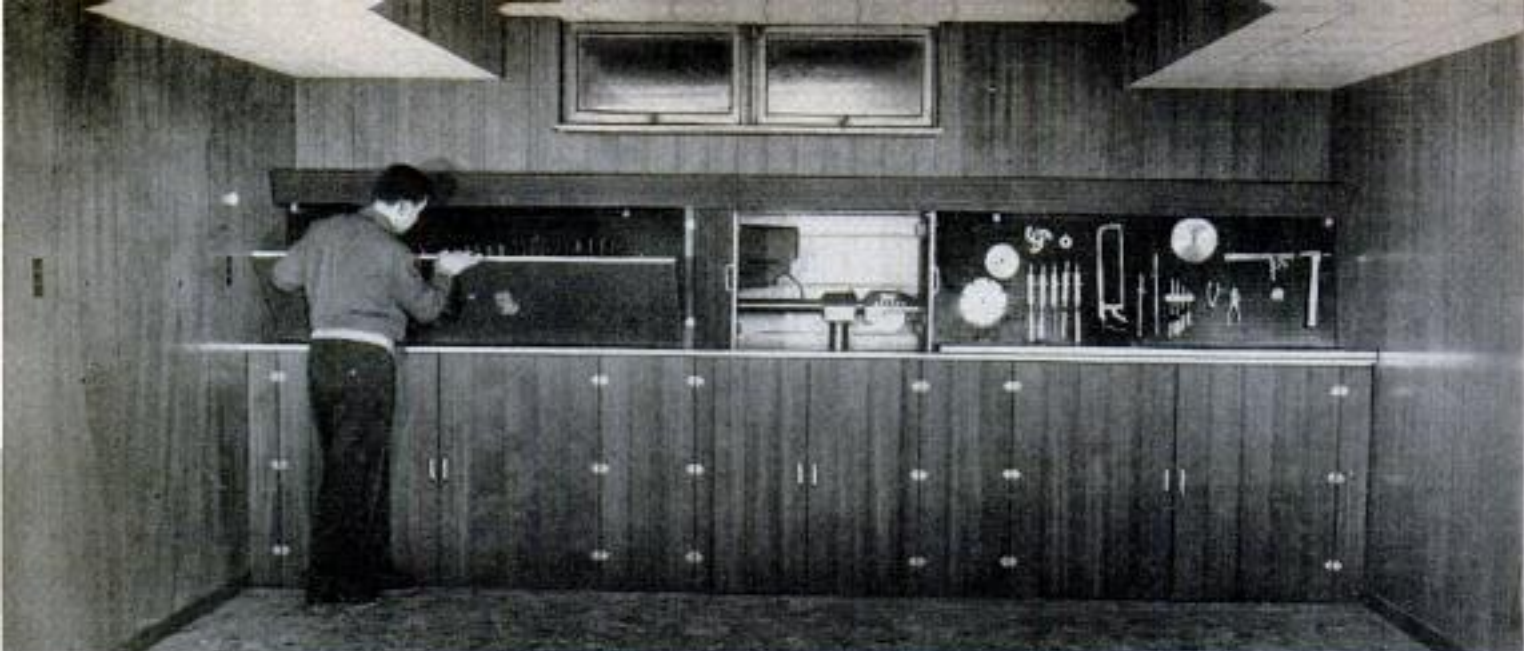

Photo above shows one of the tool-panel doors being closed while the other one rests on full-length counter



Folding HOME WORKSHOP

There is no conflict between workshop and recreation room in the home of Dorr Beale of Shopmaster, Inc. He designed and built this recreation-room power shop that folds completely out of sight in a few minutes

With workshop folded away, the full-sized recreation room, including shuffleboard, is used to full advantage



W7M 56

LACK OF SPACE need not deprive you of a home workshop and a playroom. Combine them in one room which is convertible from one to the other in a few minutes. The shop is designed around the increasingly popular combination power tool, which slides into a counter and cabinets built along one wall. Horizontally hinged doors, which conceal hand-tool panels, fold down to form a bench top over the counter. When the doors are closed, counter can be used for games or for serving refreshments. Photos on following page show construction. ★ ★ ★

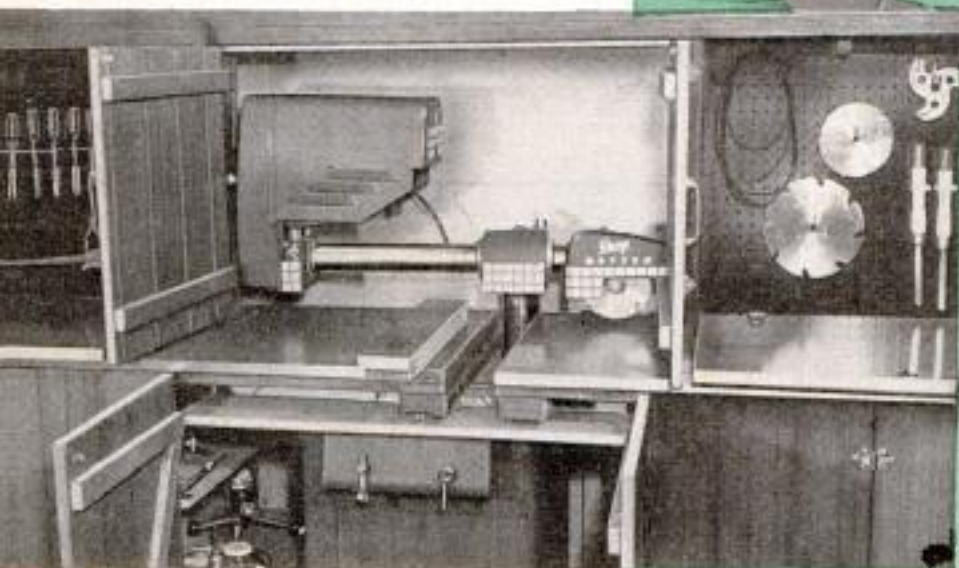

Combination power tool is stored neatly in custom-built center cabinet. Section of counter top is removed to permit entrance of the vertical column of the power tool

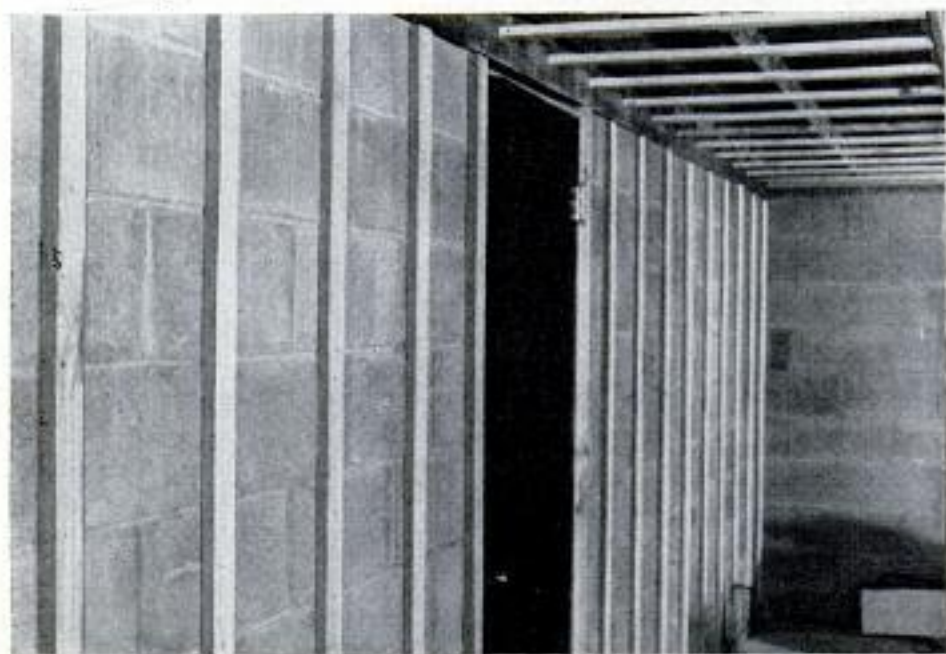

Photo above shows the combination tool being pulled from its niche in the wall cabinet. The two sets of double doors swing wide to provide clearance for the power tool. Photo at right shows tool in use within seconds of its removal from cabinet





Boxing along both sides of room is used to conceal ducts and water pipes without lowering entire ceiling



Before installing wood paneling over the concrete-block walls, it was necessary to fur out the walls with strips of 1 x 2. These were fastened to the block vertically, 16 in. apart

Simple cabinet construction can be seen from photo below. Note center shelf support and Z-bracing on doors

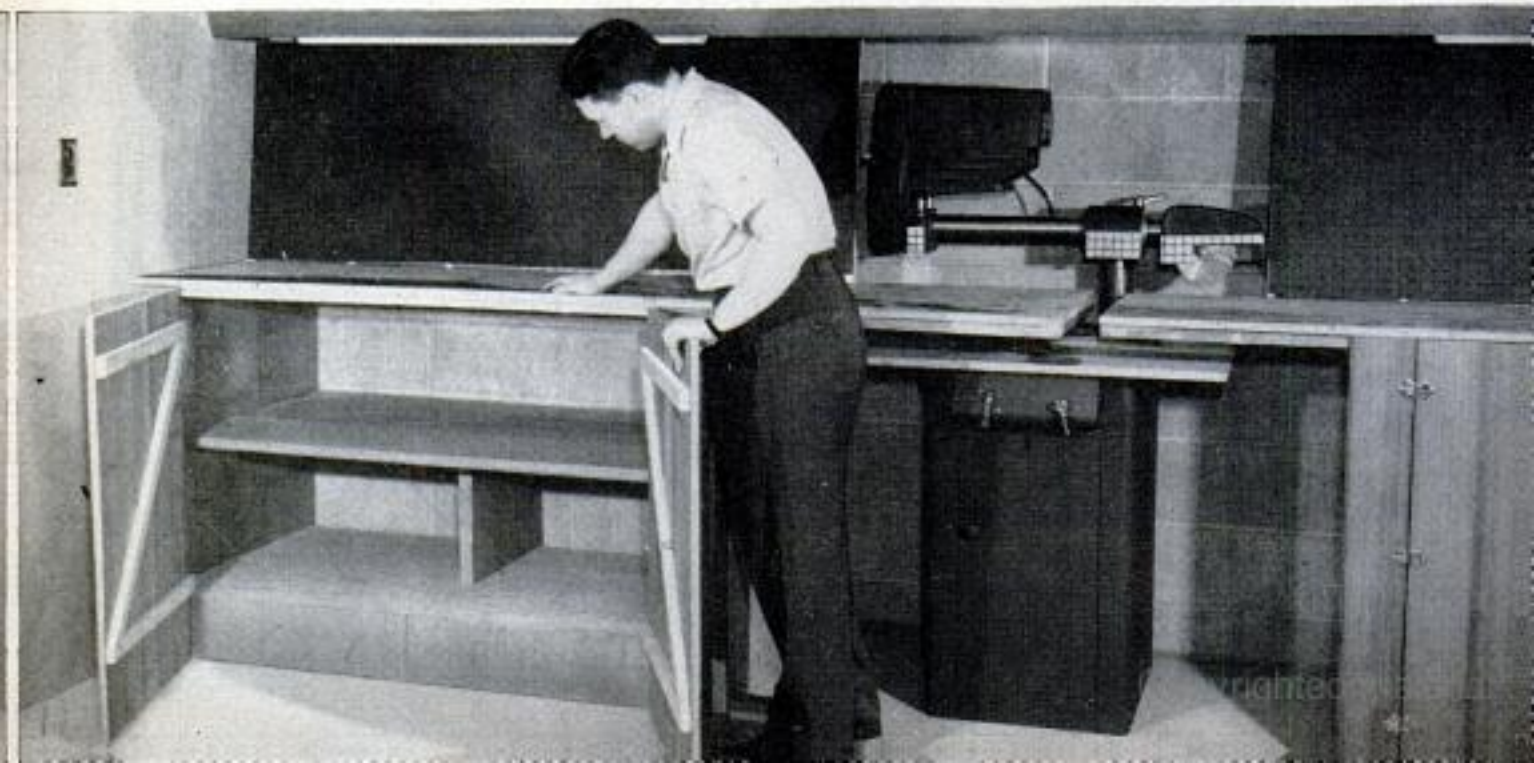

Works Salvaged From Broken Kitchen Clock Fitted in Modern Case

When the plaster case around an electric kitchen clock was broken, one home craftsman salvaged the face and motor of the clock and used them in a case of his own design, which was made from a block of hardwood and a length of coat-hanger wire. The wood block, $2\frac{3}{4}$ in. thick and 6 in. square, was recessed $2\frac{1}{2}$ in. deep x $3\frac{3}{4}$ in. in dia. in a lathe, the front edge of the recess being offset and beveled, as shown in the detail, to receive the face of the clock. Openings then were drilled in the back of the case to accommodate the knobs for starting and setting the clock. The 6 "hairpin" legs were shaped from coat-hanger wire and cemented in holes drilled in the bottom of the case. The

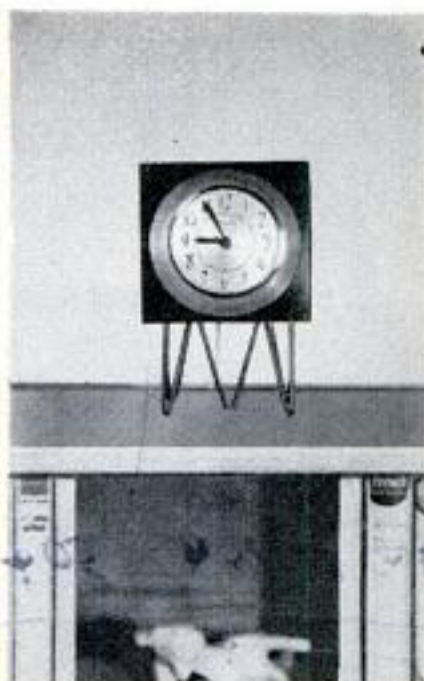
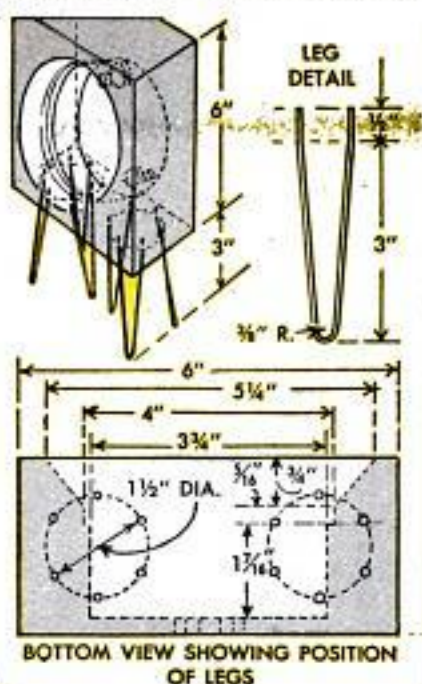

method of locating the legs is shown in the lower diagram of the detail.

Frank M. Clemmons, Churchland, Va.

Reflective-Tape "Dim" Sign Inside Rear Window Aids Night Driving

When driving at night are you sometimes bothered by the bright lights of the car behind you? Install a reflective-tape sign inside the back window that shows DIM in 5-in.-high letters to the offending driver. The sign is a sheet of light plastic, 6 x 12 in.,

hinged to the top of the window frame. Various types and models of cars will, of course, require different installations. On the original design the sign was controlled by a choke cable which was fished through the roof liner and down the windshield post. The control knob on the end of the cable was located on the dash. A pull on the control causes the sign to swing down and become visible in the rear window. The bright lights of the car behind make the sign brightly visible for 60 or 70 yards.

Lewis C. Debo, Ottumwa, Iowa.

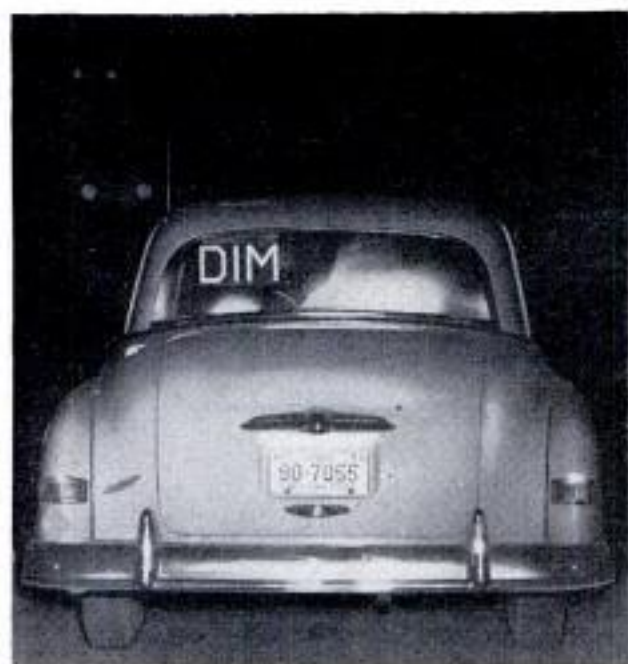

Ⓞ A discarded ice-cube tray from a refrigerator can be used as a storage box for fish-hooks, flies and other small tackle. Since such trays do not rust, the tackle can be placed in them while still wet.

Flat Filed on Door-Hinge Pin Removes Cause of Squeaking

If oiling fails to quiet a squeaky door hinge, file a shallow flat the length of the hinge pin. Squeaking is caused by a slight misalignment in the hinge or a pin that fits so tightly that oil will not

flow along it. The flat will relieve the misalignment and allow oil to flow the full length of the pin. After this has been done the hinge will require lubrication less frequently, since the flat will act as an oil reservoir.

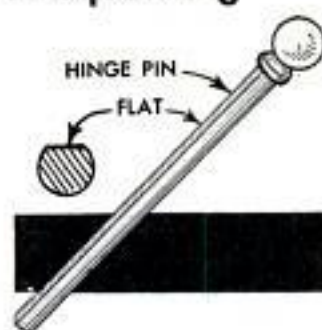

PLAN of the MONTH...



Step Table
PLANS # 104 50¢

Full-size patterns for these projects are available for only 50c each. You merely trace the design on your wood, saw and assemble. Order from Popular Mechanics Press, 200 East Ontario St., Chicago 11, Ill.

MATERIAL LIST

Plywood

- 1 pc.— $\frac{1}{4}$ " x $18\frac{1}{8}$ " x $13\frac{1}{8}$ "—Top
- 1 pc.— $\frac{1}{4}$ " x $18\frac{1}{8}$ " x $28\frac{1}{8}$ "—Step top
- 1 pc.— $\frac{1}{4}$ " x $18\frac{1}{8}$ " x $15\frac{1}{8}$ "—Shelf

Lumber

- 6 pcs.— $\frac{3}{4}$ " x $1\frac{1}{2}$ " x 18"—Front and back rails
- 2 pcs.— $\frac{3}{4}$ " x $1\frac{1}{2}$ " x 13"—Top side rails
- 2 pcs.— $\frac{3}{4}$ " x $1\frac{1}{2}$ " x 28"—Step side rails
- 2 pcs.— $\frac{3}{4}$ " x $1\frac{1}{2}$ " x 15"—Shelf side rails
- 4 pcs.— $\frac{3}{4}$ " x $1\frac{1}{4}$ " x 7"—Posts
- 2 pcs.— $\frac{3}{4}$ " x 1" x 12"—Bottom frame rails
- 2 pcs.— $\frac{3}{4}$ " x $1\frac{3}{4}$ " x 12"—Top frame rails
- 2 pcs.— $\frac{3}{4}$ " x $\frac{3}{4}$ " x $14\frac{1}{4}$ "—Post cleats
- 2 pcs.— $1\frac{3}{4}$ " x $1\frac{3}{4}$ " x $9\text{-}7/16$ "—Front legs
- 2 pcs.— $1\frac{3}{4}$ " x $1\frac{3}{4}$ " x $17\text{-}9/16$ "—Back legs
- 12 pcs.— $\frac{1}{8}$ " x $\frac{1}{2}$ " x $1\frac{1}{2}$ "—Splines

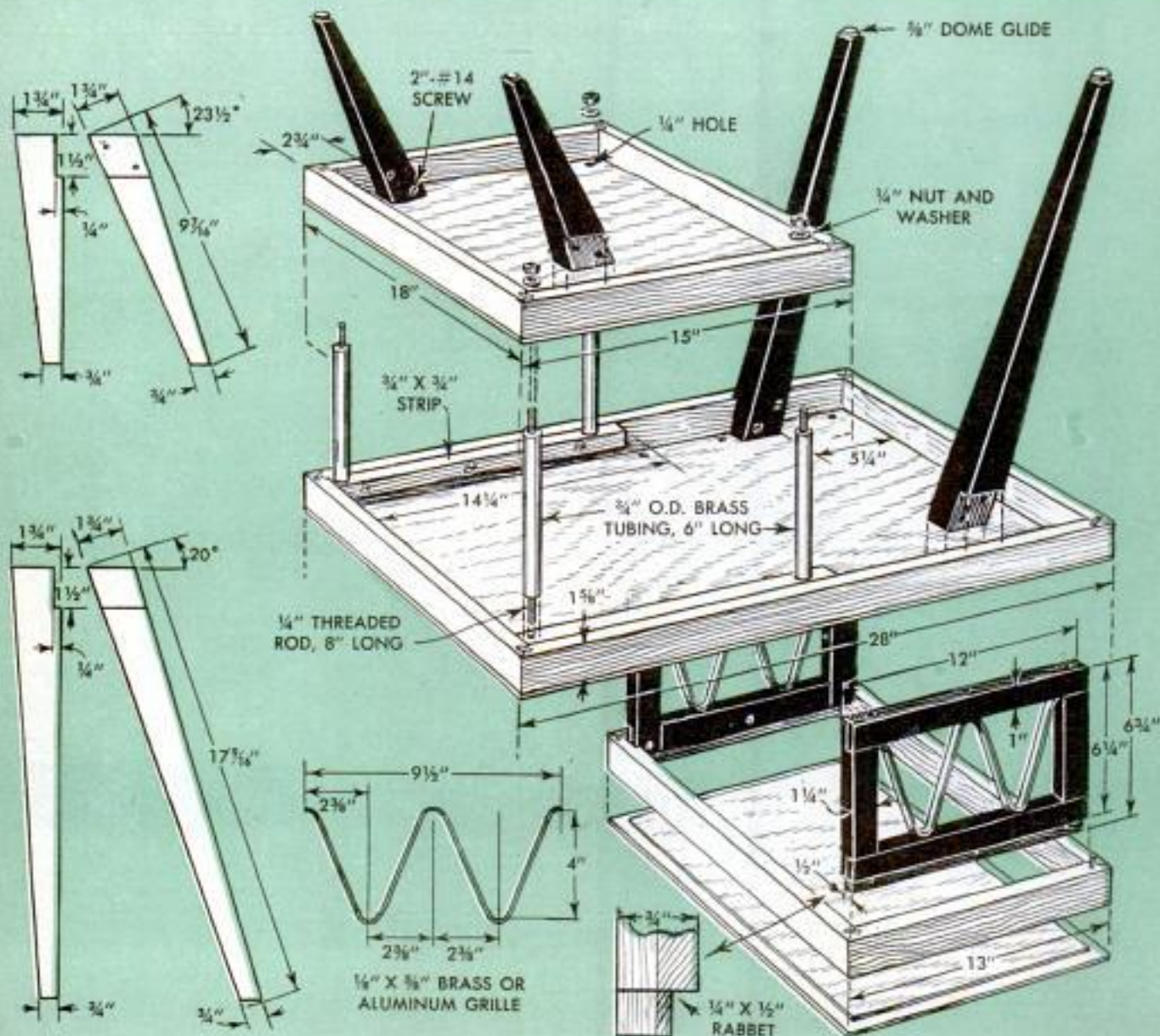

Modern Tables

WTM 56
 &
 Modern Furniture

MATERIAL LIST

Plywood

2 pcs.— $\frac{1}{4}$ " x $19\frac{1}{8}$ " x $40\frac{1}{8}$ "—Top and shelves

Lumber

4 pcs.— $\frac{3}{4}$ " x $1\frac{3}{8}$ " x 19"—End rails

4 pcs.— $\frac{3}{4}$ " x $1\frac{3}{8}$ " x 40"—Side rails

8 pcs.— $\frac{3}{4}$ " x $1\frac{1}{4}$ " x $6\frac{3}{4}$ "—Posts

4 pcs.— $\frac{3}{4}$ " x 1" x 10"—Bottom side frames

4 pcs.— $\frac{3}{4}$ " x $1\frac{3}{4}$ " x 10"—Top side frames

4 pcs.— $1\frac{3}{4}$ " x $1\frac{3}{4}$ " x $9\frac{7}{16}$ "—Legs

8 pcs.— $\frac{1}{8}$ " x $\frac{1}{2}$ " x $1\frac{1}{2}$ "—Splines



PLANS # 103 .50¢
 Cocktail Table

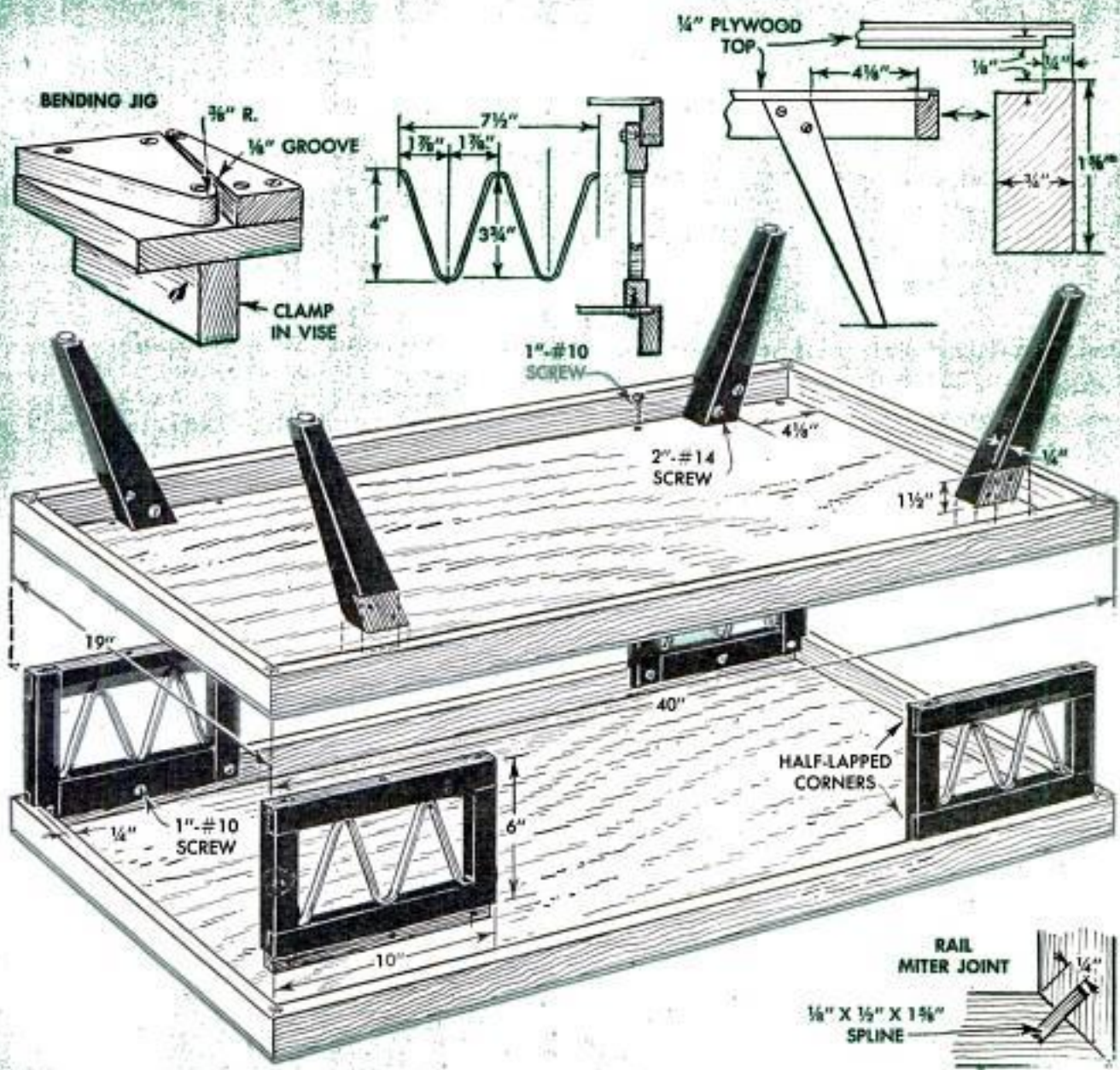

T-Square Used on Blackboard To Chalk Parallel Lines



A perforated T-square will provide a simple means of chalking horizontal lines on a blackboard. A number of equally spaced holes are drilled in a length of $\frac{1}{2}$ x 2-in. stock. A shorter piece of the lumber is screwed at right angles to one end to provide the crossbar of the T-square. In use, the crossbar is slid along the upper frame of the blackboard while the chalk is held in one of the drilled holes.

Balloon-Tired Wheel for Models Formed From Rubber Ball



Various sizes of rubber-tired wheels for toys and models can be made by fitting an axle through children's hollow or sponge-rubber balls. A hole is punched through the middle of the

ball to receive the axle, which is either a machine screw or threaded round stock

Foam-Rubber Upholstering

Foam rubber and sagless-type springs enable almost anyone to do upholstery jobs of a professional quality. Whether used for reupholstering your present furniture or for finishing a new piece, this combination will give wonderful comfort, a smooth appearance and long wear. It's all surprisingly easy, as you will discover in the fully detailed article in next month's issue

fitted with nuts. A washer or sheet-metal disk is fitted on the axle on each side of the ball to form the wheel. When the nuts are tightened against the washers the rubber ball will swell to form a realistic balloon tire.

Acidproof Plug in Glass Jug Is Rubber Sink Stopper

A rubber sink stopper will seal a glass jug tightly and is not subject to deterioration from acids, as are the usual corks or metal screw caps. Misplacing the stopper is prevented by attaching it to the handle of the jug with a rubber band cut from an inner tube. A metal chain may be used if the jug contains some liquid that is noncorrosive.



G. E. Hendrickson, Argyle, Wis.

Holder Prevents Hand Injury When Using Cold Chisel

Protection for your hand when using a cold chisel may be provided by a holder made from two lengths of 1-in. stock and a heavy rubber band. Each length of stock is beveled on the inside surface near the end and a notch is cut 3 in. from the end to receive the chisel. A shallow notch on the outside of each strip keeps the rubber band in place. The chisel is held by gripping the two lengths of stock near the ends, as shown in the photograph. Rounding the corners of the stock will make a more comfortable handgrip. A claw hammer, as shown in the photograph, may be used for light work, but a ball-peen hammer is preferable for all work.

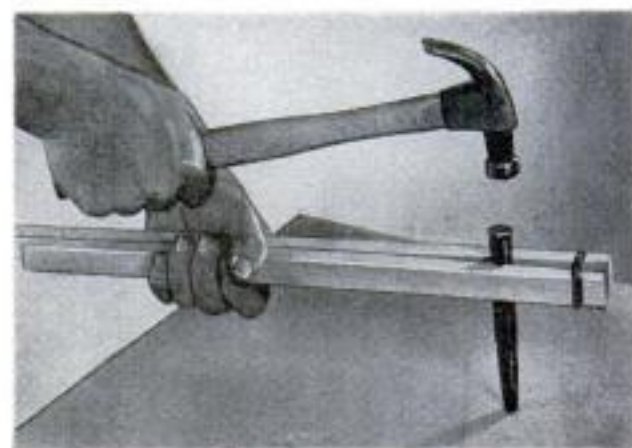

HOW TO INSTALL A VENT FAN IN YOUR KITCHEN

Installing a kitchen fan is a simple do-it-yourself job that any handy homeowner can do himself with a few common tools

DO YOU KNOW that as much as a pound of grease a day is deposited on the walls and ceiling of your kitchen? Every time food is cooked, minute droplets of grease attach themselves to the vapors given off. As soon as these vapors come in contact with a cooler object or surface, they condense, leaving a greasy deposit. Without a means of expelling these grease-laden vapors, the grease is absorbed by draperies, upholstery and clothing and settles as a film on the walls, woodwork and cabinets in the kitchen.

Besides keeping the kitchen cleaner and decorating bills lower, a ventilating fan makes the kitchen a more pleasant place to work by ridding the room of odors. In hot weather, it is much appreciated for its fast action in exhausting the excess heat produced from cooking, and for its effect in cooling the room in general.

There are two general types of kitchen fans on the market—wall and ceiling. Some can be converted for either use. The wall type has the advantage that it can be placed



very close to the range. But where there is no wall space over the range, a ceiling-type fan often can be used to better advantage. This is true also where the range is located on an inside wall, as it will require less ductwork to vent a ceiling fan than it would to vent a wall fan located on an inside wall.

A third installation that might be preferred is in a kitchen cupboard or stove hood. In such an installation, the fan is mounted in a horizontal position in the bottom of the cupboard and vented with a

TYPICAL OF THE VARIOUS VENT FANS on the market are those pictured below. This representative group includes both wall and ceiling models, as well as propeller and full-pressure types. All are easy to install

Pryne and Co., Inc.



NuTone, Inc.



American Blower Corp.



H.G. Electric Co.



Stewart Industries, Inc.



NuTone, Inc.



IN AN INSIDE WALL

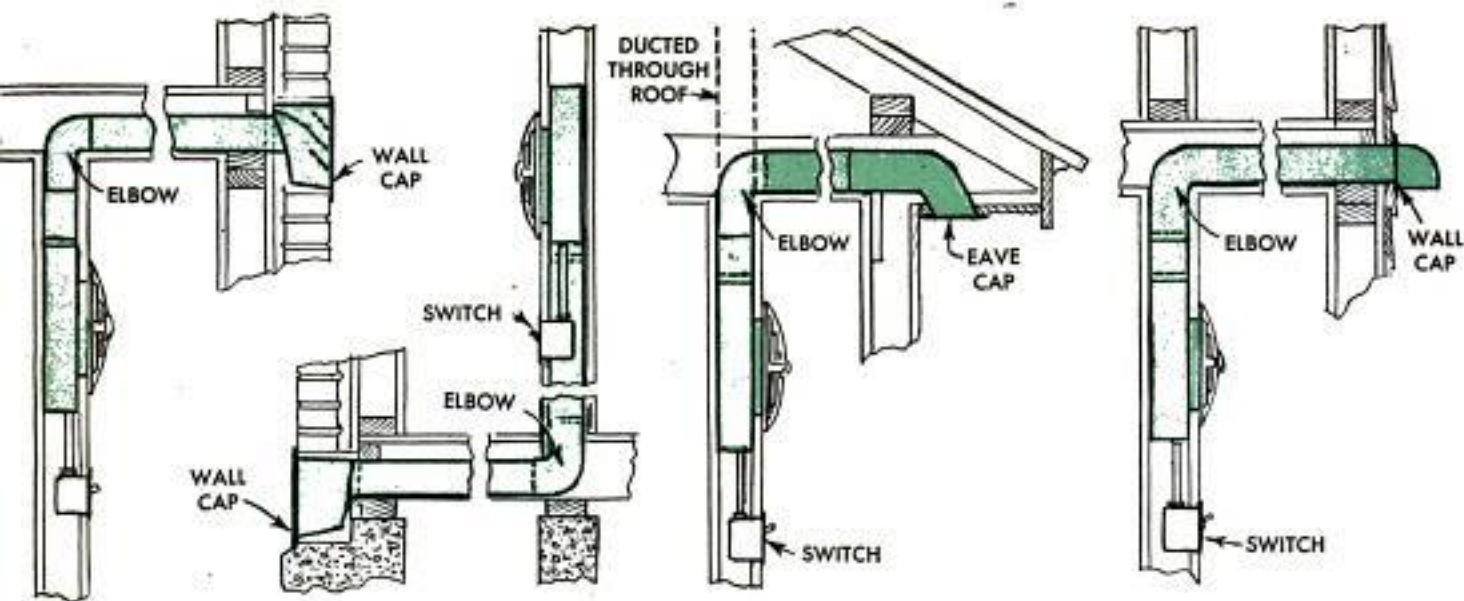

IN THE CEILING

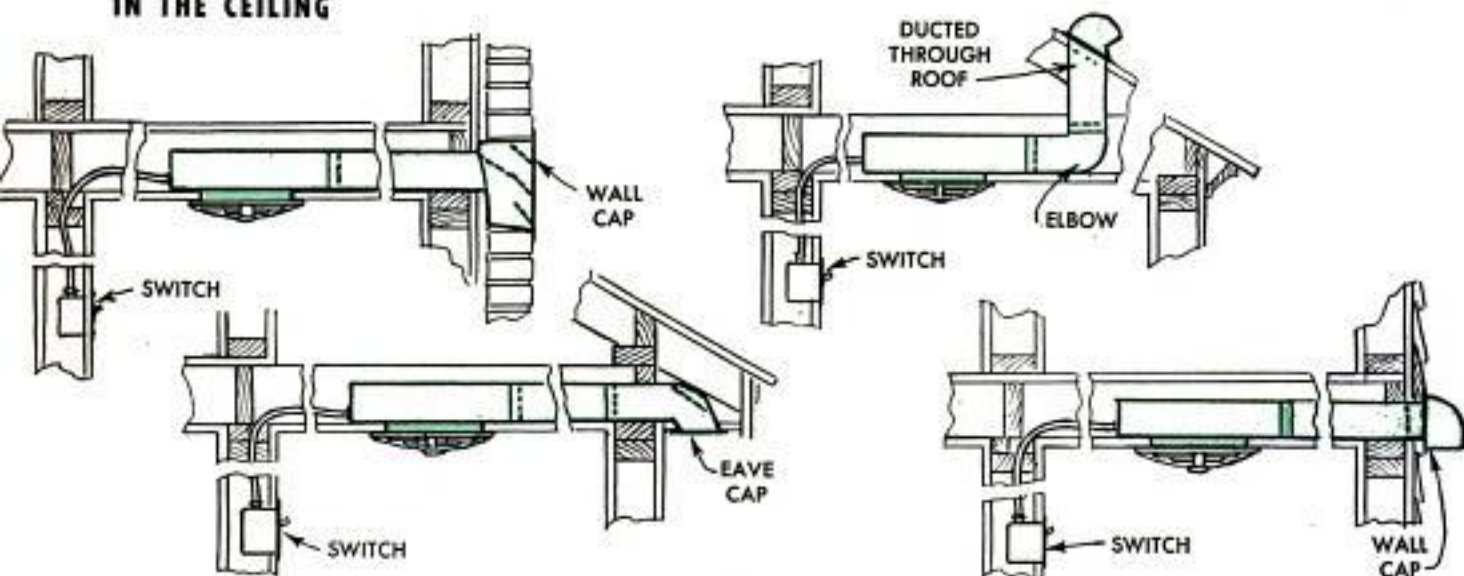

IN AN OUTSIDE WALL

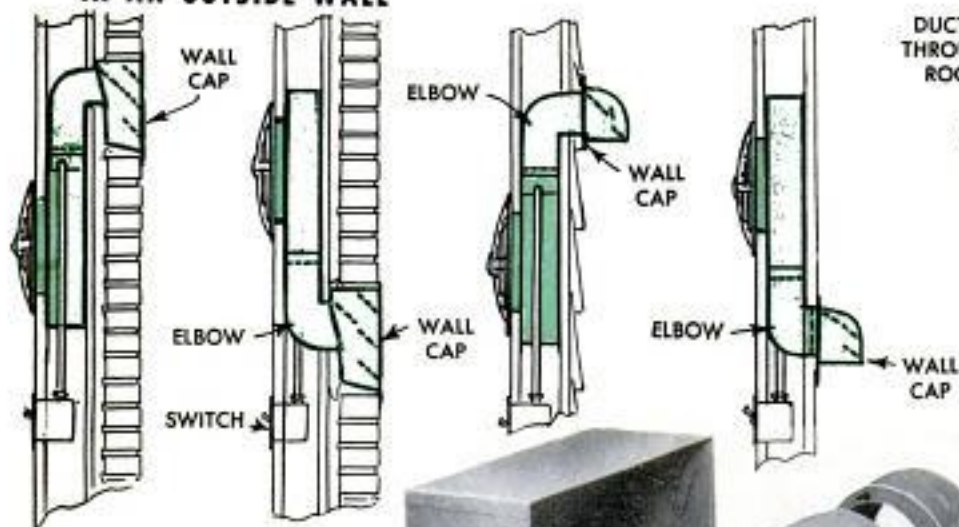

IN A CABINET

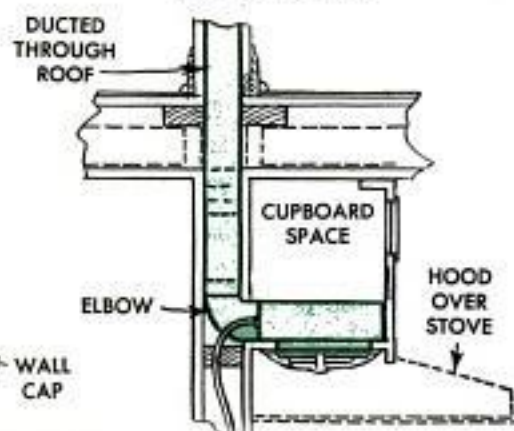

Right, component parts of compact "twin blower," full-pressure fan. Ideal for cabinet or hood installation directly over kitchen range. Fan may also be ceiling mounted



Photo courtesy NuTone, Inc.

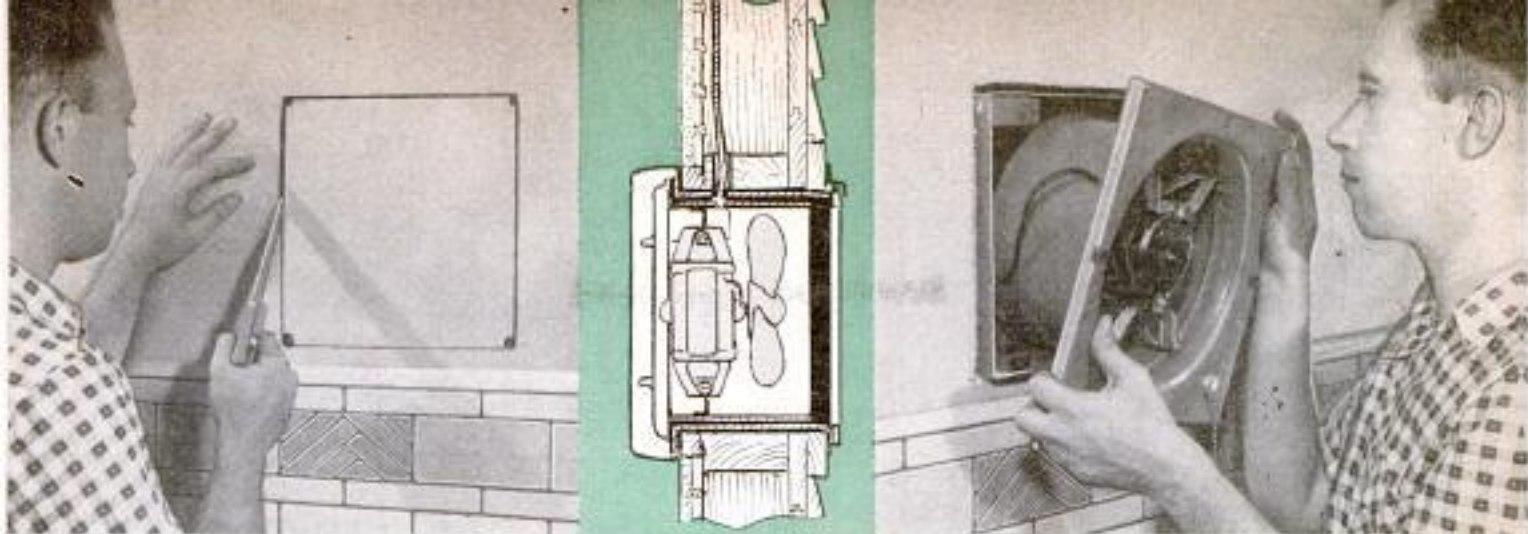

Photos show steps in mounting typical fan in outside wall. Square sheet-metal outer housing, containing lift-up door and built-in switch, bolts to fan assembly in pillbox fashion. Features plastic grille

duct running up through the wall. You can buy a compact "twin blower" pressure-type fan ideally suited for cabinet installation, although some wall and ceiling-type fans can be adapted.

One manufacturer has recently offered a unit designed for multiple ventilating. Here, an 800-c.f.m. fan is mounted outside the house, either on the roof or wall, where it pulls from one, two or three separate grilles located in different rooms. Thus, any combination of rooms can be served, such as kitchen only, kitchen and utility room or kitchen, bath and game room.

The best location for a fan is to have it as close as practical to the range since its most important function is the removal of grease-laden vapors. If it is possible to mount the fan in a wall, it should be located 12 to 18 in. above the top of the range. This is an exceptionally good location, especially if it should happen to be an outside wall, as no duct work is required to vent it. Even if the range is located on an inside wall, but only a few feet from an outside wall, it is still more practical to install the fan on the outside wall. It will save a lot of work, and perform just as satisfactorily.

Where a ceiling installation is more practical, the fan should be located so not more than 10 ft. of duct work is required to vent it to an outside wall. If a ceiling fan is installed in a one-story house, it can be vented through the roof with a vertical run of pipe fitted with a regular sheet-metal



American Blower Corp. photo

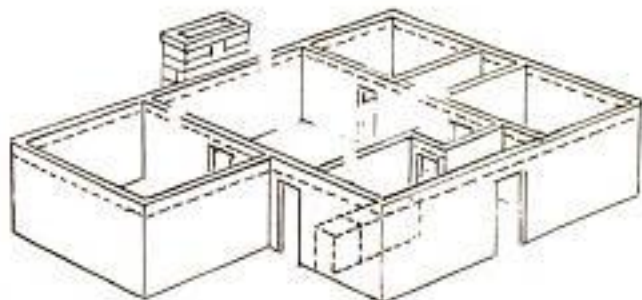

New multiple-ventilating idea permits one, two or three rooms to be ventilated with a single fan mounted outside the house, either on the roof or a side wall

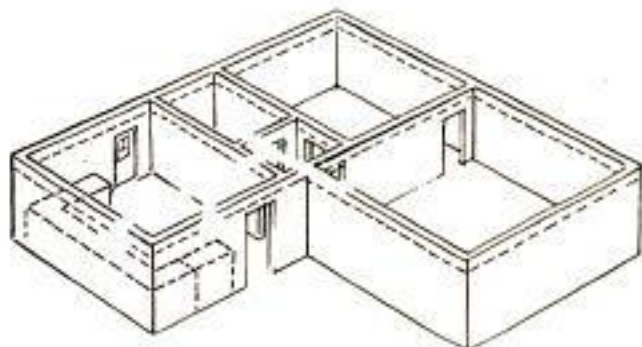

Below, this particular type of fan differs from others in that motor and blade are actually outside house in weatherproof casing. Makes for quiet operation

Stewart Industries, Inc. photos

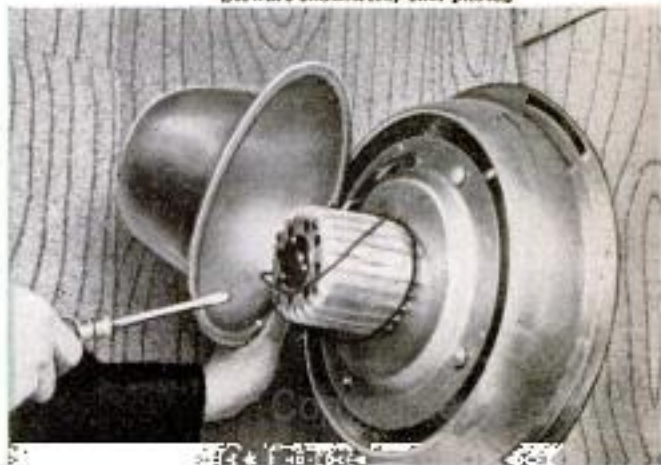
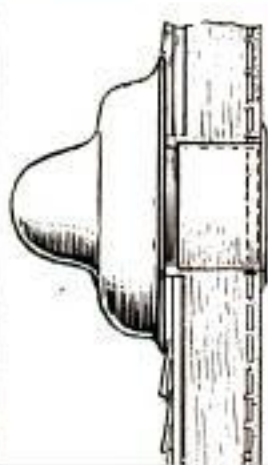
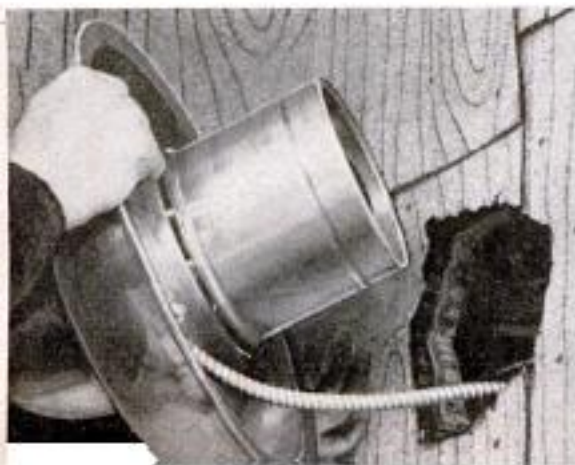



Periodic cleaning of this 10-in. ceiling fan requires unscrewing single thumb bolt to remove grille, unplugging fan and lifting out latter as shown below



Below, reducer capping top of housing takes standard 8-in. furnace pipe to vent fan through roof as in drawing at right. The reducer has back-draft damper

vent cap. This type of installation is shown being made on page 216. Here you see that a minimum of ductwork is required and, consequently, the job is less expensive.

In deciding on location, keep in mind that the best pattern of air movement in a kitchen is to have the air sweep across the range on its way to the fan. Thus, if it is not practical to locate the fan directly above the range because of wall cabinets, locate the fan so that air will pass over the range before getting to the fan. Keep in mind also that air entering the kitchen should come from other rooms of the house rather than from an open window or door. Where a fan is located on an outside wall and near a door or window, keep it closed when the fan is operating. Otherwise, air will be drawn in through the open window or door and be "short circuited" out again via the fan without ventilating the kitchen.

In selecting the right-sized fan for your particular kitchen, you should first decide how fast you want the air to be replaced with fresh air. The Power Fan Manufacturers' Association recommends that the air should be changed completely once every two to three minutes. This means that if a kitchen should contain 1200 cu. ft. of space and you want a 3-min. air change, a fan rated at 400 c.f.m. should be selected; a 2-min. air change would require a fan capable of delivering 600 c.f.m. The 2-min. rate is often recommended for a small kitchen where a faster rate of air exchange would trap odors before they have a chance to spread to other parts of the house. Regardless of how small a kitchen might be, a fan rated at 300 c.f.m. should be absolute minimum for efficient ventilation.

Installing a fan, either wall or ceiling

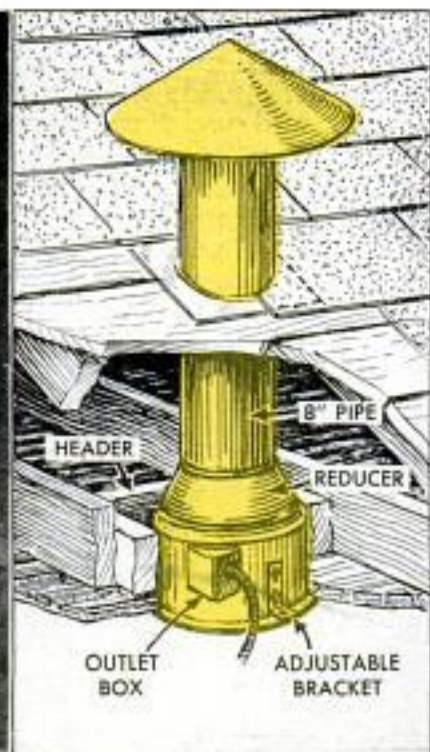

type, is a fairly simple job, particularly when it is located in an outside wall, or in a ceiling and vented through the roof. Obviously, more work and expense are involved in running duct work up through an inside wall of an existing house. Obviously, too, it is an easier job where the wall is frame, rather than brick. In laying out the opening in a frame wall, try to locate it so that a stud will form one side of the opening. Since both the inside and outside openings must be in line, a good way to assure this is to use a cardboard pattern cut to the required size and shape. This is taped in place to the plaster and a line is drawn around it. Then a hole is drilled through the center of the pattern and right through the outside wall. After this, the cardboard pattern is taken outside, registered squarely over the hole in the wall, taped in place and marked as before. A hole is bored in each corner of the square for sawing out the openings with a keyhole saw. This step is shown being done at the top of page 215 for installing an Aeropel fan. If metal lath is encountered in sawing through the plaster, use a hacksaw blade.

Most kitchen fans are equipped with a sheet-metal wall box, or sleeve, and an outlet section fitted with a door that mounts flush to the exterior wall. Additional wooden trim or frame may or may not be needed. For those fans that do require a frame, a simple one of 1 x 2 strips can be made, mitering the pieces at the corners and nailing them together with corrugated fasteners. In fitting the frame in place, trim back the siding, or shingles, as the case may be, around the opening to permit the frame to fit flat against the sheathing. Where a frame is not needed, but the outlet box has a flange, this same procedure is used. Calking around the flange, in both frame and brick walls, provides a positive seal.

Some fan units slip together like a "pill-box," one inside the other, and it is therefore important to see that the outer section is squared up properly. Otherwise, the grille on the inside will be out of square. When mounting the fan unit inside the outer section, make certain that the wall



The Vent-A-Hood Co. photo

Vented canopy projects over range to effectively trap cooking vapors. Protects back wall from grease splattering. Has built-in light and exhaust fan. Comes knocked down for installation between wall cabinets

flange is adjusted to the plaster line so the flange and grille will fit securely against the wall. Improper adjustment here may cause noisy operation due to vibration.

A typical ceiling-fan installation is shown in the cutaway drawing on the opposite page. This particular fan (NuTone) has a tubular sleeve or flanged housing which is held against the ceiling by sheet-metal ears (L-shaped brackets) attached with sheet-metal screws to the outside of the housing. A reducer, containing a back-draft damper, is supplied to fit the top of the housing for venting the fan through the roof with ordinary 8-in. galvanized pipe. The motor-and-fan unit is suspended inside the housing on rubber bushings. By tightening a center thumb bolt which secures the grille, the motor unit is seated securely in position. The motor plugs into a built-in receptacle inside the housing which makes it easy to remove the motor-and-fan unit for periodic cleaning. As a rule, ceiling-type fans operate from a wall switch, whereas a good many wall-type fans are controlled with a pull chain which opens the outside louver and turns the fan on at the same time. ★ ★ ★

Photo Prints Straightened With Rubber Pad and Dowel

Curled prints can be straightened by using a sponge-rubber pad, a wooden dowel and a block of wood. The print is placed on the pad, face down; then the dowel is rolled across it with one hand while pressure is applied with the block of wood held in the other hand. Some practice is required to determine how much pressure to apply and how long to roll the dowel. *Caution:* Papers with extremely brittle emulsions may be cracked by this method.



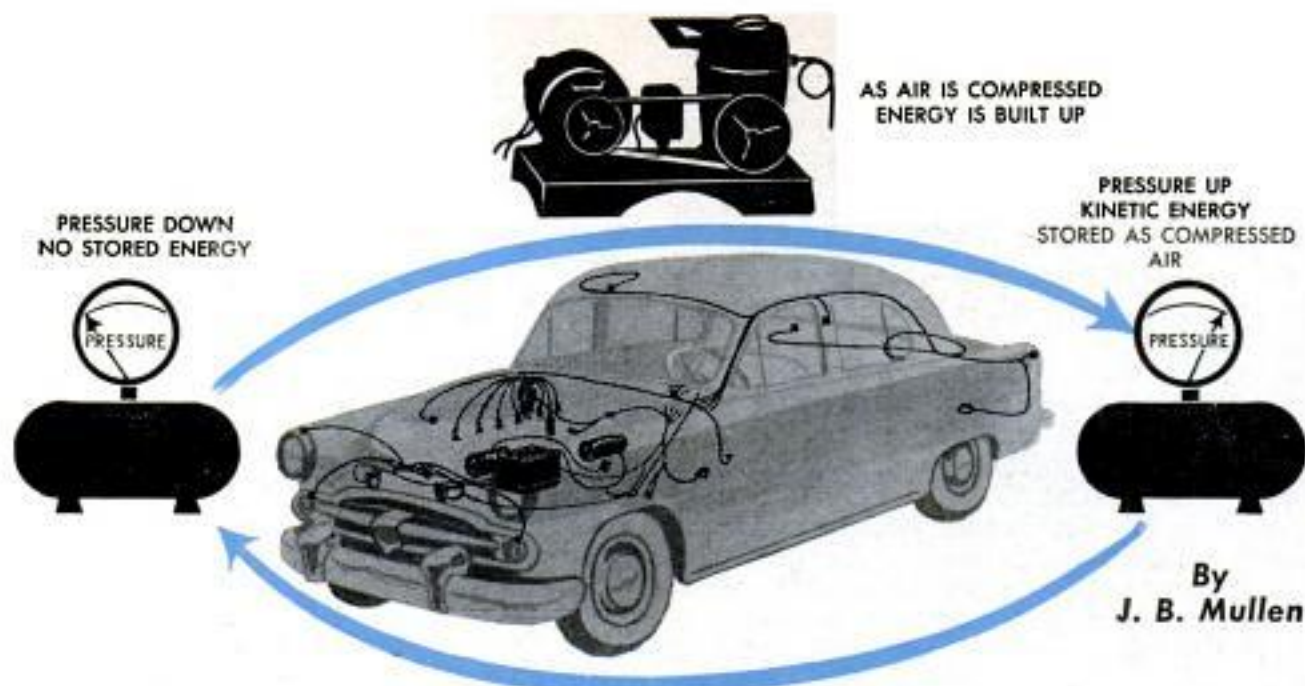

YOUR CAR BATTERY—How It Works

WHEN YOU SERVICE your car don't forget the battery, either summer or winter. It's easy to overlook the battery as it never attracts attention due to unusually noisy operation or other warning of impending failure. It will need periodic cleaning to neutralize the acids that may corrode terminal posts, cable connections and the metal rack in which it is supported. It will need a "shot" of distilled water in each cell once every two or three weeks during the summer months. In cold weather you will need to keep a careful check on the generator charging rate to make sure it is maintained at full charge. If the battery becomes discharged it may freeze in cold weather. Note readings and temperatures in Table I.

The lead-sulphuric-acid storage battery, or secondary battery, is almost universally used in cars. It's simply a chemical plant in a box. It stores chemical energy in the plate materials and releases it as electrical

energy as the plate materials go through a chemical reaction. This is diagrammed at the top of the opposite page, stages 1, 2, 3 and 4. Note the movements of the various components in the four stages shown and then compare this with the look into the battery box, or case, that you get in the cutaway view below. The processes are continually reversed; that is, after the battery is discharged, electrical energy can again be stored as chemical energy.

The energy cycle of the battery is comparable in some respects to that of an air-compressing unit. Mechanical energy is stored in air under compression and is later released as mechanical energy by means of any one of a number of devices designed to convert and utilize it. Compare the diagram at the top of page 218 with that at the bottom of page 219 and you will see the analogy between the "energy cycles" of compressor and battery.

Referring again to stages 1 to 4 inclusive

SP. GR. at 60° F.	SP. GR. at 32° F.	FR. PT. in ° F.
1.150	1.162	+7
1.175	1.187	-2
1.200	1.212	-14
1.225	1.237	-32
1.250	1.262	-55
1.275	1.287	-82
1.300	1.312	-95

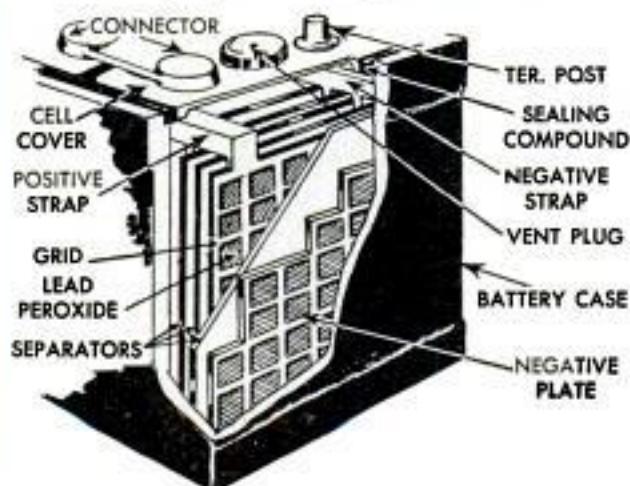

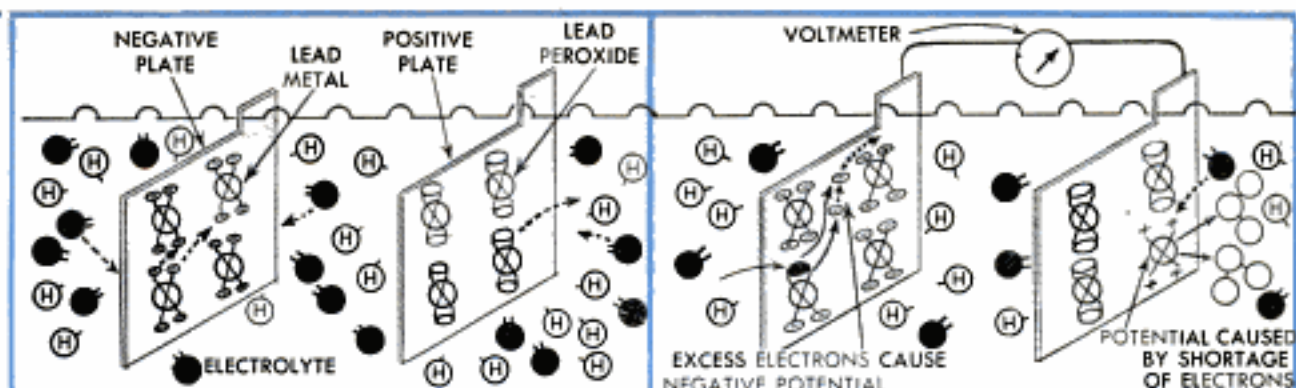

1 FULLY CHARGED PLATES TEND TO REACT BY COMBINATION OF LEAD WITH SULPHATE IONS

2 SLIGHT REACTION OCCURS. REACTIONS LEAVE PLATES CHARGED, WHICH STOPS REACTIONS

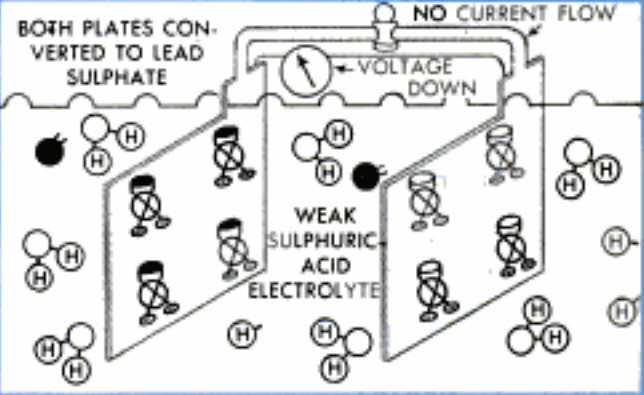
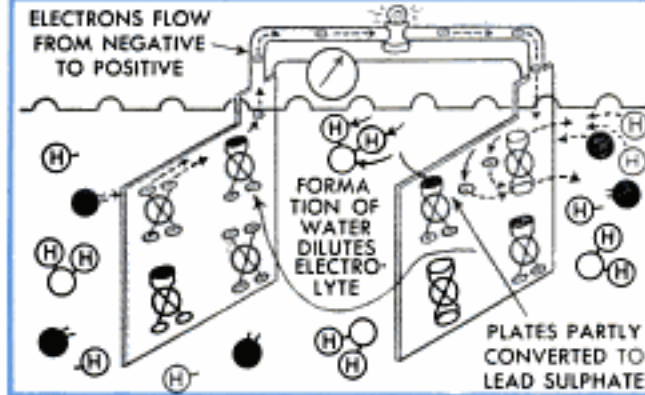

3 CIRCUIT PROVIDES PATH FOR ELECTRONS FROM NEGATIVE TO POSITIVE. REACTIONS CONTINUE

4 BATTERY FULLY CHARGED WHEN ACTIVE MATERIAL IS CONVERTED INTO LEAD SULPHATE

LEAD	UNCHARGED ATOM WITH 4 ELECTRONS		ION WITH 2+ CHARGE (HAS GIVEN UP 2 ELECTRONS)	
ION WITH 4+ CHARGE (HAS GIVEN UP 4 ELECTRONS)	SULPHATE ION WITH 2 NEGATIVE CHARGES		HYDROGEN ION WITH 1 POSITIVE CHARGE	
OXYGEN (COMBINED) WITH 2 NEGATIVE CHARGES	ELECTRON A UNIT NEGATIVE CHARGE		PATH OF PARTICLES DURING REACTIONS	

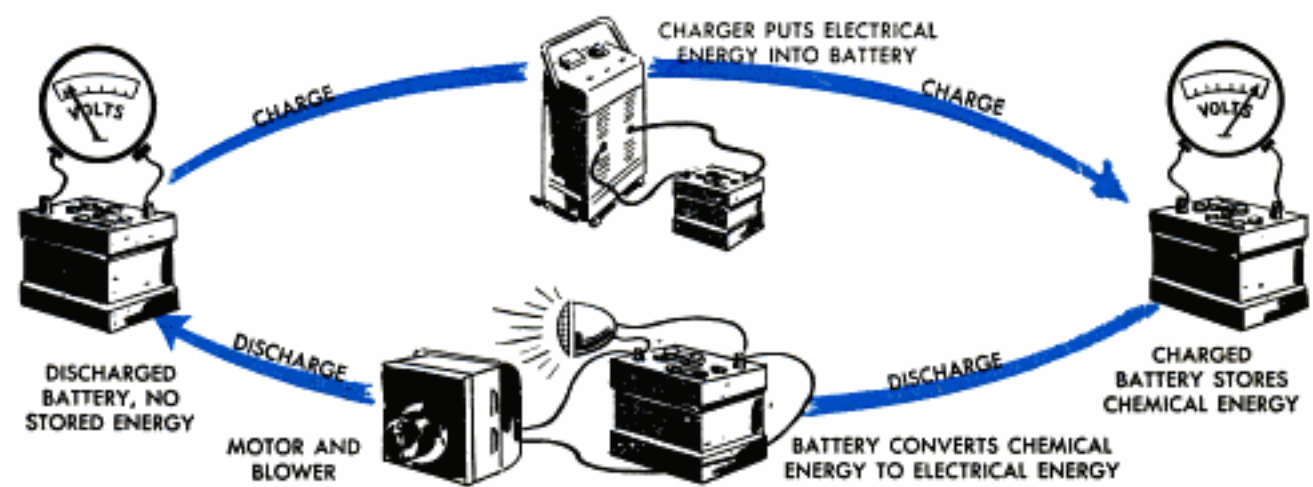
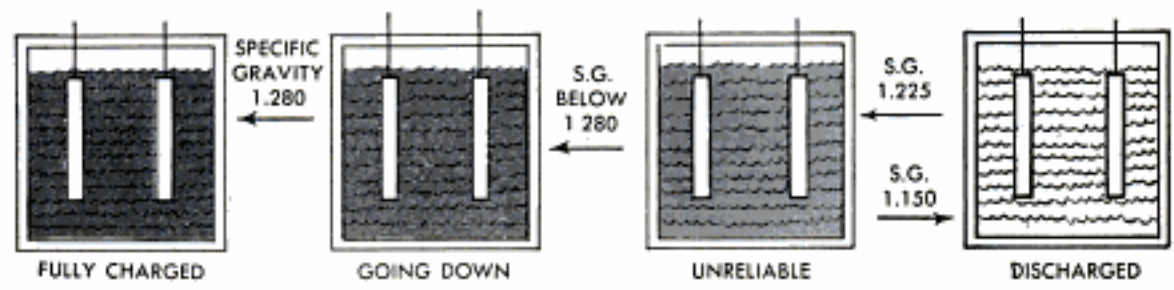

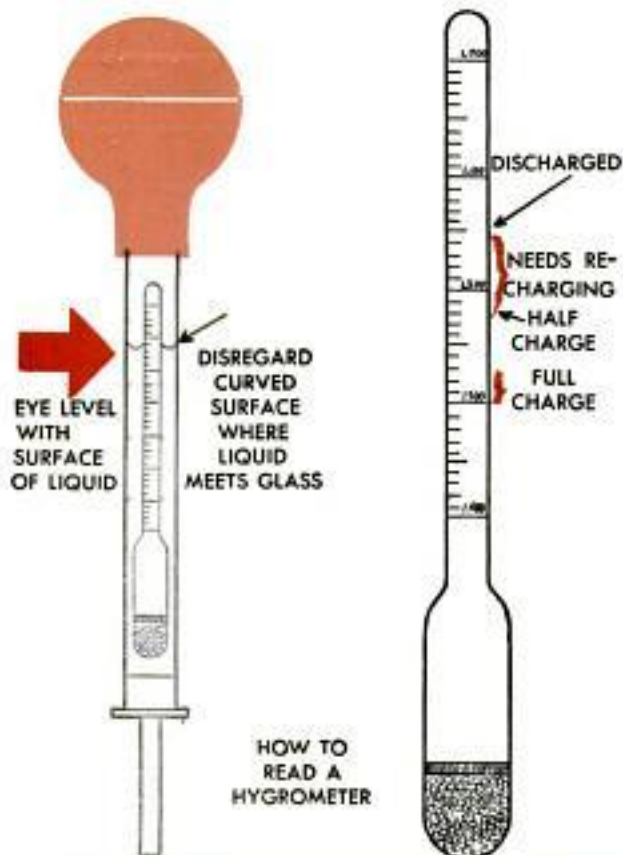
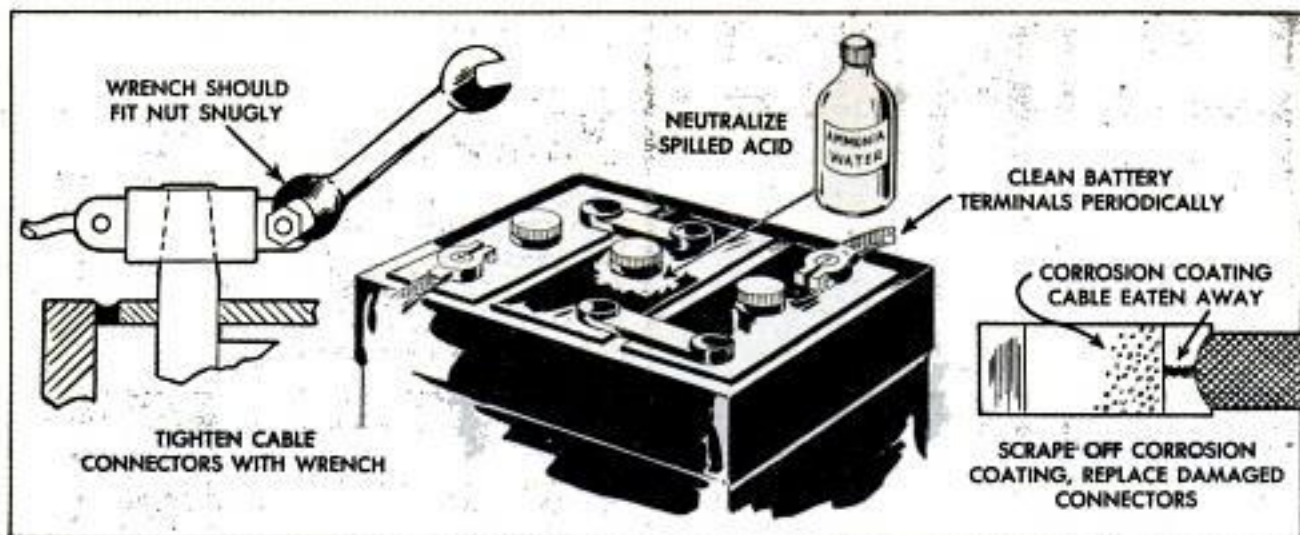

in the diagram on page 219, note first the symbols and then follow them through the four stages. At the negative plate lead, atoms give up two negative electrons per atom, thus becoming lead ions with two negative charges per ion. The charged lead ions combine with negatively charged sulphate ions in the acid electrolyte to form lead sulphate. The latter is not soluble and remains in position on the plate. The plates thus acquire a negative charge relative to the solution. The amount of this charge and the positive charge on the positive plate are what is meant by the voltage of the cell. Unless the electrons can flow away, the process which has been going on quickly reaches an equilibrium and stops.

When the battery is connected to a load, the electrons on the negative (lead) plate flow through wires and the load. In the meantime, as fast as the electrons leave the negative plate, the equilibrium between lead atoms, ions and electrons is displaced and more lead atoms will give up electrons, become ions and combine with sulphate ions to form lead sulphate. The process continues as long as the load is connected,

	ACTIVE MATERIALS		INACTIVE MATERIALS
ACTION AT POSITIVE PLATE	Lead Peroxide plus 4 Hydrogen ions plus sulphate ion plus 2 electrons $Pb^{2+}O_2 + 4H^+ + SO_4^{2-} + 2e^-$	yields	Lead Sulphate plus 2 Water $Pb^{2+}SO_4 + 2H_2O$
ACTION AT NEGATIVE PLATE	Lead plus Sulphate ion $Pb^+ + SO_4^{2-}$	yields	Lead Sulphate plus 2 electrons $Pb^{2+}SO_4 + 2e^-$
OVER-ALL REACTION	Lead plus Lead Peroxide plus 2 Sulphuric acid $Pb^+ + Pb^{2+}O_2 + 2H_2SO_4$	yields	2 Lead Sulphate plus 2 water $2Pb^{2+}SO_4 + 2H_2O$

The reactions that take place in a storage battery cell on discharge. The reactions on discharge are the reverse of the reactions on charge, and the inactive materials are restored to the active form

Small +, -, and * signs above symbols for lead and other materials represent sign and number of charges on ions and show change of charge in course of reactions

or as long as there are uncombined lead atoms on the negative plate to give up electrons.

Similar processes are taking place at the positive plate. Lead peroxide consists of oxygen combined with lead which has already lost four electrons per lead atom when the lead peroxide was formed. These highly charged lead ions (four positive charges) take up two negative electrons each, becoming ordinary lead ions with two positive charges which combine with sulphate ions to form lead sulphate. Oxygen of the lead peroxide combines with hydrogen ions from the electrolyte to form water. The discharge reactions end with the reactive material of both the positive and negative plates converted to lead sulphate. Complete cell reactions are given in the table on the opposite page. Also note the four stages shown in the center view on page 219, from fully charged to complete discharge.

On recharge, the chemical changes are reversed. Current from the generator or charger delivers electrons to the negative plate. These convert the positively charged lead ions of the lead sulphate back to metallic lead, freeing the sulphate ions, which go back into solution. At the same time the lead ions in the lead sulphate on the positive plate give up electrons again and are converted to lead dioxide with the sulphate ions going back into solution. When the charge is completed the plates are back in the original condition.

The battery is built to withstand repeated charge and discharge cycles and will give regular service as long as the active material remains in place on the plates with its porous structure unchanged. Keep a periodic check on the condition of the electrolyte with a hydrometer as in the center detail on the opposite page. Be sure that you read the hydrometer correctly in order to determine the exact reading. At full charge the reading may vary between 1.270 (or 1.280) and 1.300. If the reading is much below 1.270, say 1.225, the battery is unreliable and needs recharging. The charging rate of the generator should be checked and readjusted immediately. Also, check the level of the electrolyte in each cell and add distilled water if necessary to bring the level of the liquid above the plates. While you're at it, check the cable connections with a wrench as in the details at the top of the opposite page. Be sure the wrench fits the clamp nut snugly. Scrub the top of the battery and its metal holder, or support, with ammonia water. Replace corroded cables. Coat metal parts with petroleum jelly. Be sure battery is tight in holder. Check the clamping bolts and, if necessary, renew rubber washers. ★ ★ ★

Fiberglas-Plastic on Boat Deck Replaces Painted Canvas



One of the newest materials to be used for waterproofing the decks of cabin cruisers is Fiberglas-reinforced plastic. The old canvas is first removed, a coat of resin is applied and the Fiberglas cloth then is smoothed onto the resin-coated surface. A second coat of resin is applied over the cloth to finish the job. In some instances, two or three layers of the cloth impregnated with the resin are advisable for additional strength.

Drum Attached to Belt Sander Provides Dual-Purpose Machine

A small-diameter sanding drum, coupled to the drive shaft of a belt sander, permits sanding sharply curved surfaces on which the flat belt cannot be used. A regular shaft coupling is used to connect the drum to the drive shaft of the sander. Some modification of the coupling may be required to fit it to the shaft.





Coil Springs Provide Tension To Guide Lines on Blinds

Large, slatted blinds used on screened-in porches can be prevented from flapping noisily in the wind by fitting coil springs to the top ends of the guide lines. The springs are hooked to shelf brackets which hold the lines out from the wall slightly less than the diameter of the rolled screen. The bottom ends of the guide lines are fitted with S-hooks which engage screw eyes driven into the wall near the floor.

Blow Dust From Your Negatives



Dust can be removed from a negative without danger of scratching by blowing through a glass drinking straw and directing the concentrated jet of air over the surface of the negative. When the air in the dark-room is dry enough to cause a static charge to build up on the surface of negatives, causing them to curl and

become hard to handle, your breath through the straw, because it is humid, will clear it away.—Robert C. Florian, Chicago.

Wood Filler Mixed as Needed

One craftsman makes nonshrinking filler by mixing powdered whiting, 3 parts, and powdered resin-type glue, 1 part. The mix-

ture is inexpensive and can be stored for a long time without deterioration. When needed, water is added to make a paste. The filler does not shrink and color may be added to it to match the wood on which it is used.—Rudolph Sacchetti, Baltimore, Md.

Flush-Tank Sweating Prevented By Supplying Heated Water

The problem of a sweating flush tank can be overcome by heating the water in the tank to room temperature or slightly above. Where a constant supply of hot water is available, a mixture of hot and cold water can be piped into the tank, as shown in the diagram.

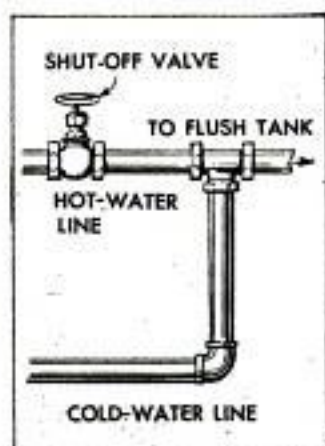

Some experimenting will be necessary to determine the amount of hot water required to provide the correct final temperature.—H. V. Buschmann, North Wilmington, Mass.

Electric Shaver Quickly Cleaned With Discarded Hairbrush

A discarded hairbrush, because of its firm bristles, makes an excellent cleaner for the shaving head of an electric shaver. A few light passes of the hairbrush over the shaving head will do a quicker and better job than the small brush usually supplied with a shaver, and the longer bristles permit a more thorough cleaning of the comb and cutter when disassembled.—Glen F. Stillwell, Manhattan Beach, Calif.

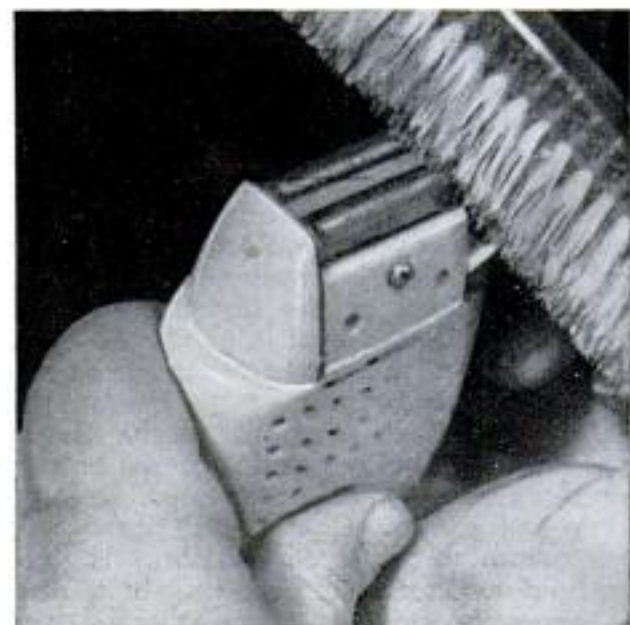

Shop Notes

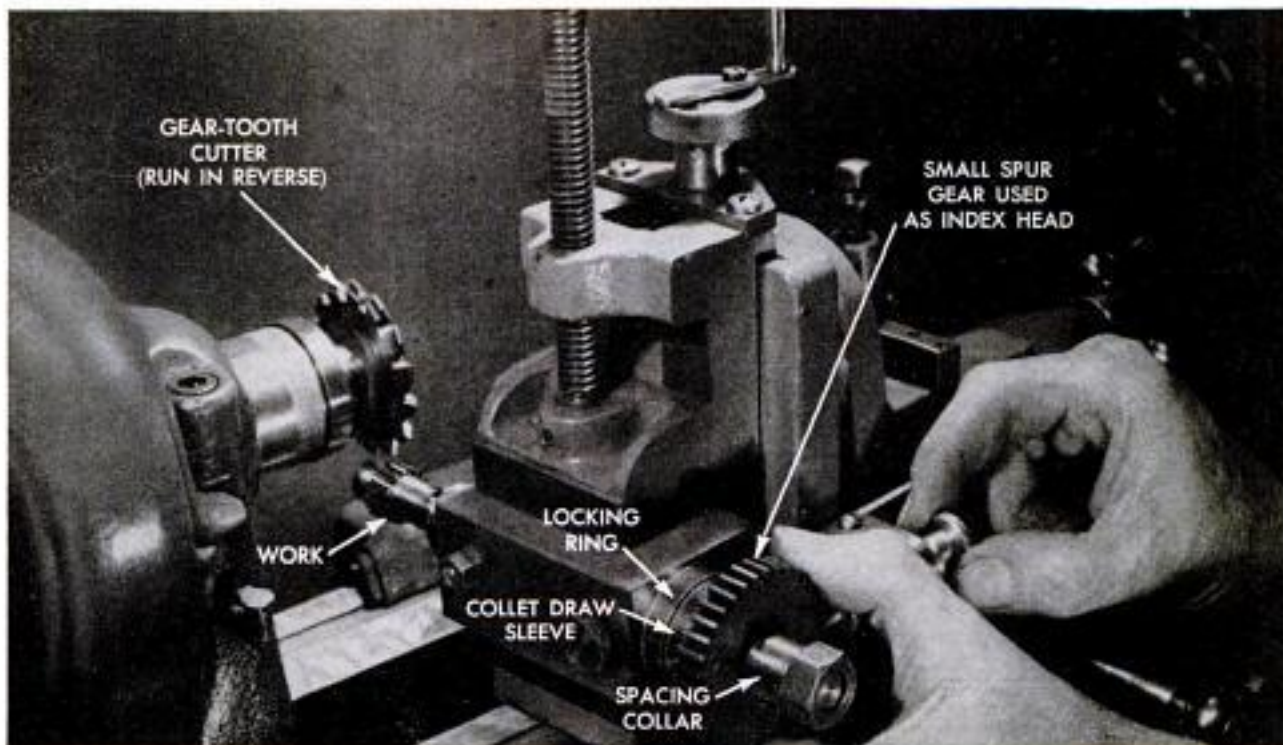

Indexing attachment in typical setup for cutting teeth on small gear. Note that gear is used as index head

INDEXING ATTACHMENT for small lathes

By Walter E. Burton

SSMALL MACHINE SHOPS, modelmakers and others who use a lathe for a variety of machining operations, often encounter a job requiring use of an indexing head. This one is especially designed for use in the lathe milling attachment. As

Outer diameter of the spindle can be finished by careful filing. File should be stroked uniformly

pictured in the photo above, it consists of a collet, collet draw sleeve and a mounting block to which an indexing stop is attached. For many jobs, a spur gear will serve as the indexing head.

The parts are shown in the keyed details,

Small end of the spindle is threaded to take the locking ring which holds spindle in mounting block



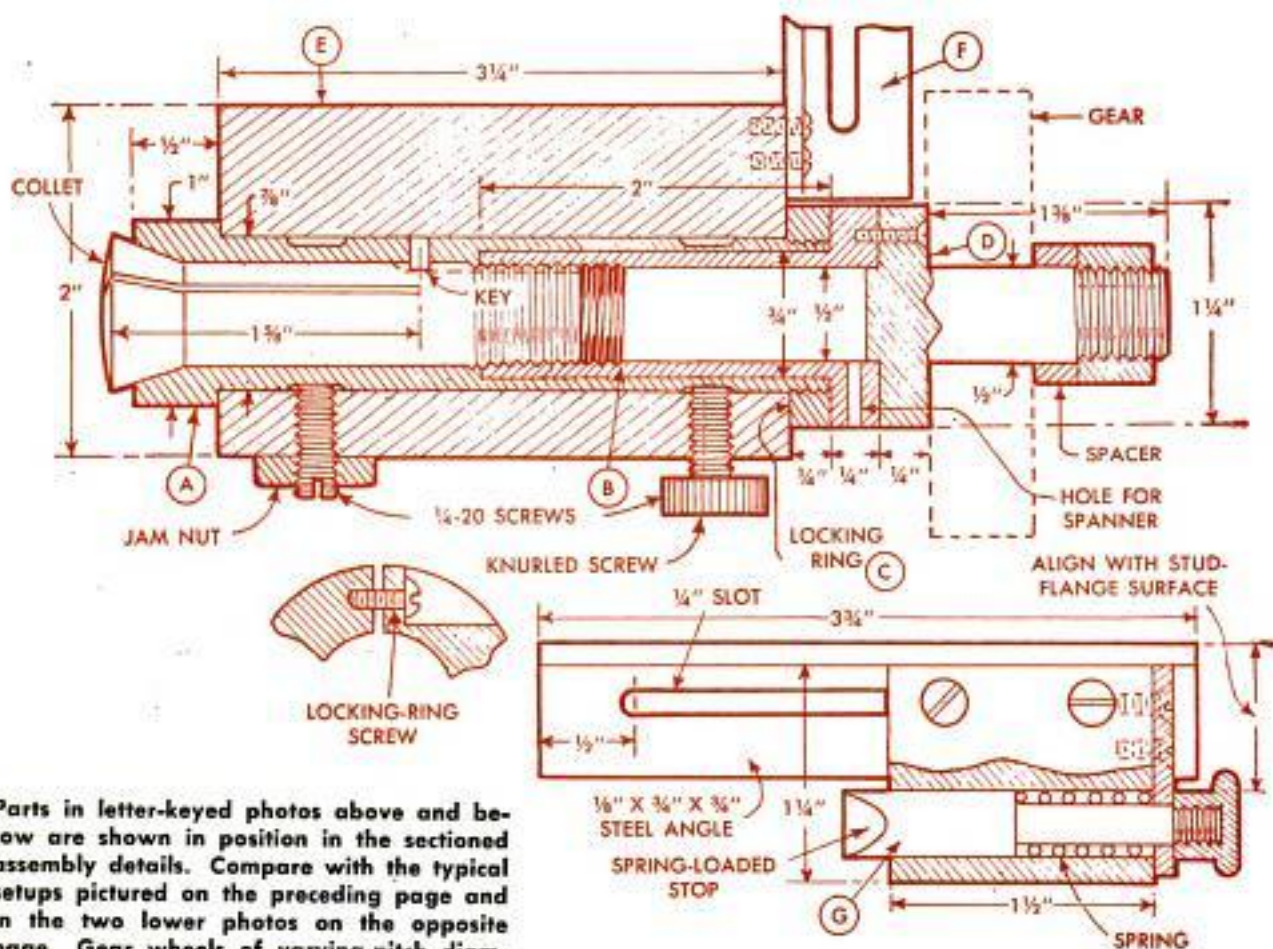
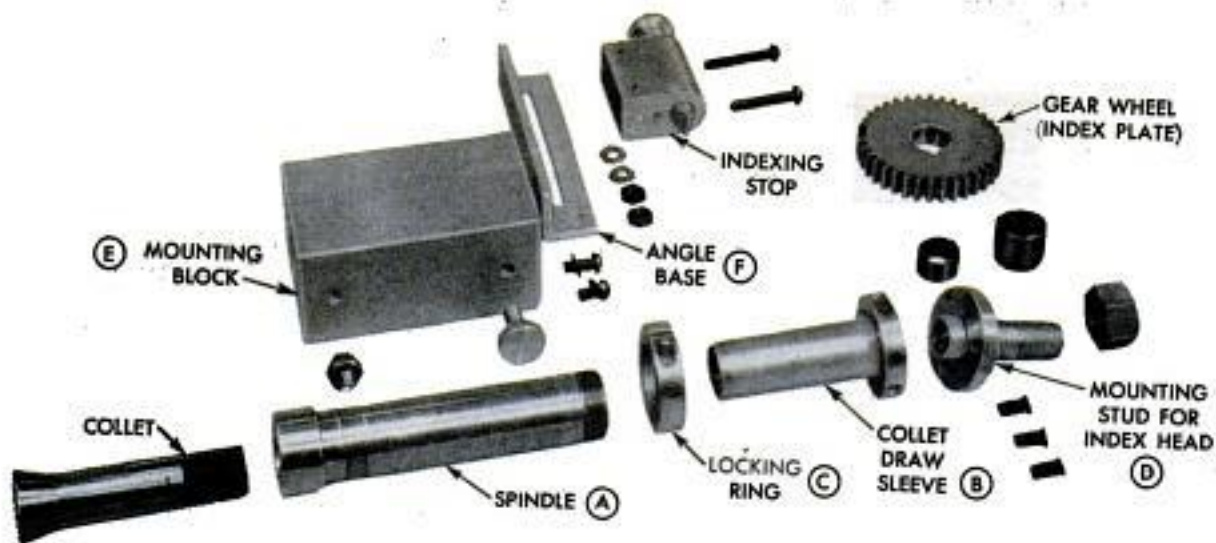

Parts in letter-keyed photos above and below are shown in position in the sectioned assembly details. Compare with the typical setups pictured on the preceding page and in the two lower photos on the opposite page. Gear wheels of varying-pitch diameter can be used for the most common indexing requirements. Standard collet is used



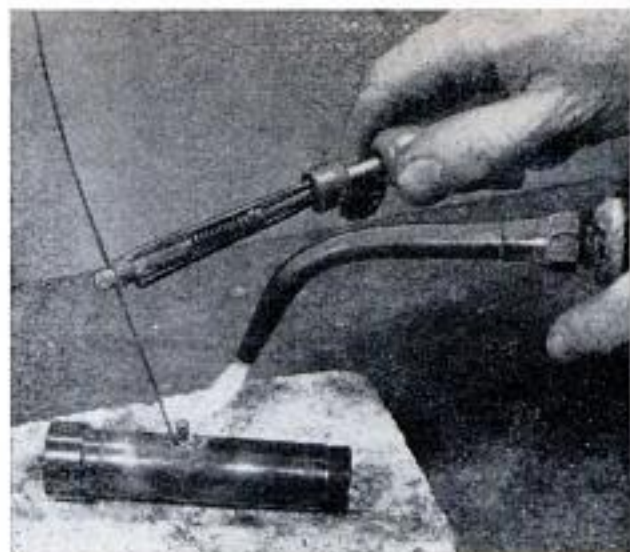

Silver-soldering key in the spindle which engages a groove in the collet to prevent it from turning

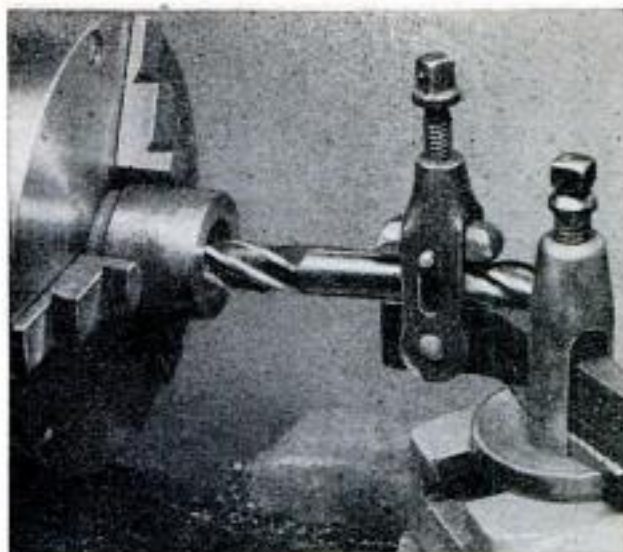

Cutting the taper in the spindle nose can be done with an ordinary milling cutter. Note the setup used

A to G, inclusive, also the photos on the opposite page. The simplest machining operations turn out a unit capable of doing very accurate work. The first step is turning the spindle, part A. Note that the outer end is shouldered down and the bore is tapered to form a closure for a standard collet. The bore also is counterbored to take the collet draw sleeve, part B. This passes through the locking ring, part C, its internal thread engaging the collet, as in the sectional view. The mounting stud, part D, is flanged and has a projection which fits snugly inside the outer end of the draw sleeve as in the sectional view. The outer end is threaded to take a standard $\frac{1}{2}$ -in. hex nut. Next, the mounting block, part E, is drilled and tapped as indicated. Note that in the assembly a key is silver-soldered in a hole drilled in the spindle to engage the slot in the standard collet to prevent it from turning in the spindle. The two photos below picture setups using gears of various sizes. ★ ★ ★

Setup for milling a hex head on the end of small rod. Milling vise permits movement in two directions

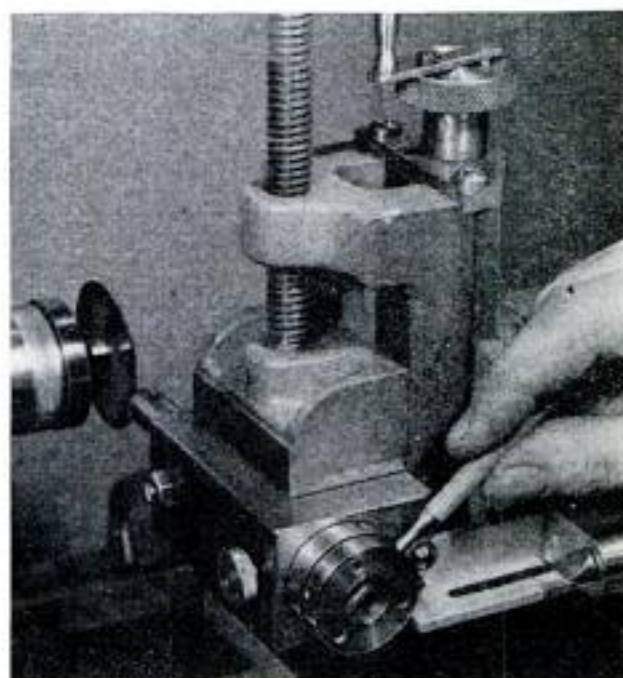

Collet is tightened on work by turning draw sleeve with spanner wrench or with a pin punch as pictured

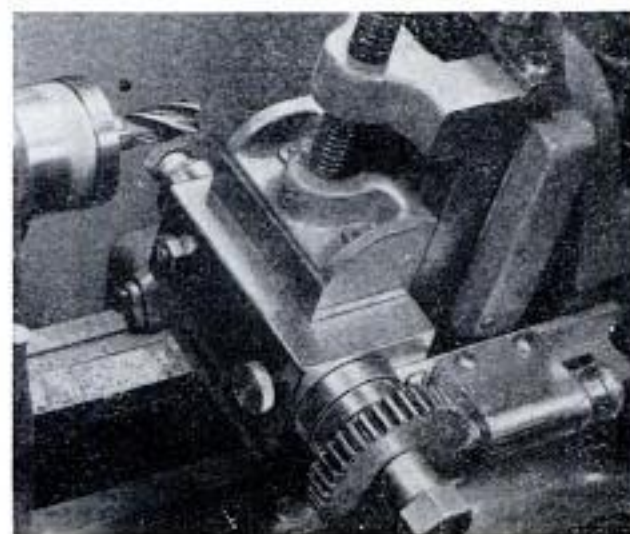

Gear wheel used as indexing head is chalk-marked into the number of divisions required by the work



"Pressurized" Protective Hood Keeps Out Paint Spray

To prevent the paint mist from working in under his protective hood when spraying in close quarters, one painter "pressurized" his hood. A length of copper tubing is stitched to the cap of his helmet and one end is inserted in a hole cut in the visor. A filter cloth is tied to the end of the tubing to disperse the air inside the hood. A suitable length of small rubber hose is slipped over the free end of the copper tubing and connected to a valve on the air line. The valve need be opened only slightly to provide sufficient air pressure inside the hood.

William R. Palmer, Tuckahoe, N. Y.

Knob on Side of Grain Spout Helps Fill Feed Basket

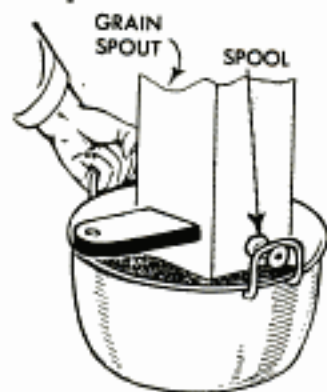

Filling a feed basket from a grain spout can be simplified by providing a knob to hold one handle of the basket, thus freeing one hand to operate the slide. The knob is a spool screwed to the spout.

Disposable Tissues In Workshop Provide Safety Factor

Although not often thought of as a shop accessory, disposable cleansing tissues can be used for dozens of jobs around the workbench. Their absorbent qualities make them ideal for wiping up paint spots and, dipped in thinner, they can be used to remove paint

from hands and clothes. Used with gasoline or other solvent, the tissues quickly remove grease from tools. Because they are disposable, the tissues eliminate the chances of spontaneous combustion presented by oily rags or waste.

Frank A. Bartonek, Kansas City, Mo.

Identifying Letters on Milk Can "Painted" With Soldering Iron

To overcome the problem of having to frequently repaint the identifying initials on milk cans, "paint" the letters with solder, which will last almost as long as the can itself. First, clean the spot on the can with emery cloth, then apply flux and tin the metal. Scratch an outline of the desired letters and apply several layers of solder with a torch or iron to build them up.



G. E. Hendrickson, Argyle, Wis.

Sliding Wedge Used as Jack To Level Heavy Machinery

Confronted with a job where regular leveling jacks and wedges could not be employed, one maintenance man used the screw-action sliding wedge shown in the detail. Faces of both contacting surfaces are hardened, as are the roller pins which lie in half-open holes in the wedge. The rollers project only $\frac{1}{64}$ in. above the surface.

Charles H. Willey, Penacook, N. H.

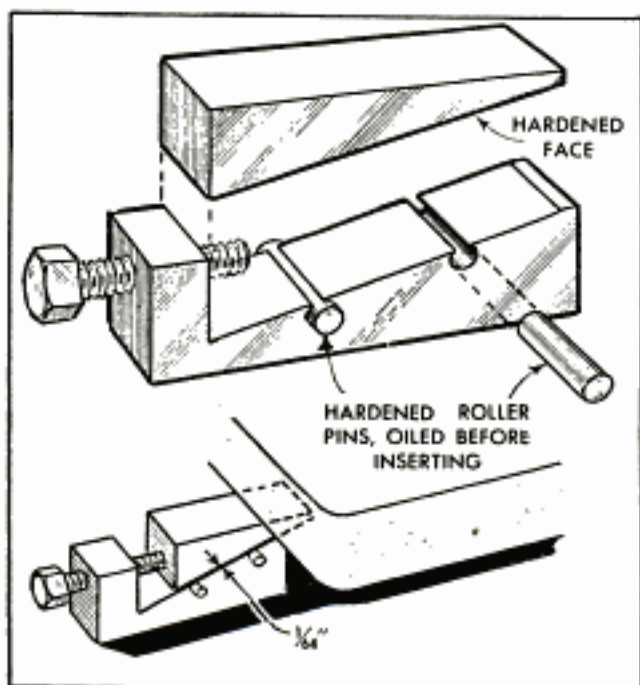

"Floating" Lathe Holder for Drilling or Reaming



This holder "floats" the reamer or drill into precise alignment when drilling or reaming from the tailstock. It consists of a head which is a 2-in. length of $\frac{3}{4}$ -in.-dia. steel round one end being drilled $1\frac{5}{8}$ in. deep and tapped $\frac{1}{4}$ -28 to receive the threaded end of the handle. The hole is counterbored $\frac{1}{2}$ in. deep with a $\frac{1}{4}$ -in. drill, and the end of the head is tapered to $\frac{1}{2}$ in. Flats $\frac{3}{8}$ in. wide are milled on opposite sides of the head and $\frac{3}{16}$ -in. dovetail slot is milled along one flat, as in the end view. A $\frac{5}{16}$ -in. hole is drilled through from the opposite flat and the hole is filed to a V-shape, as indicated. The dovetail slide fits snugly into the milled dovetail and is center-drilled to take the 60 deg. lathe center. In use, a drill or reamer is fitted into the V-shape hole and the handle is screwed in to lock it in place. The setup is made as in the lower right-hand detail.

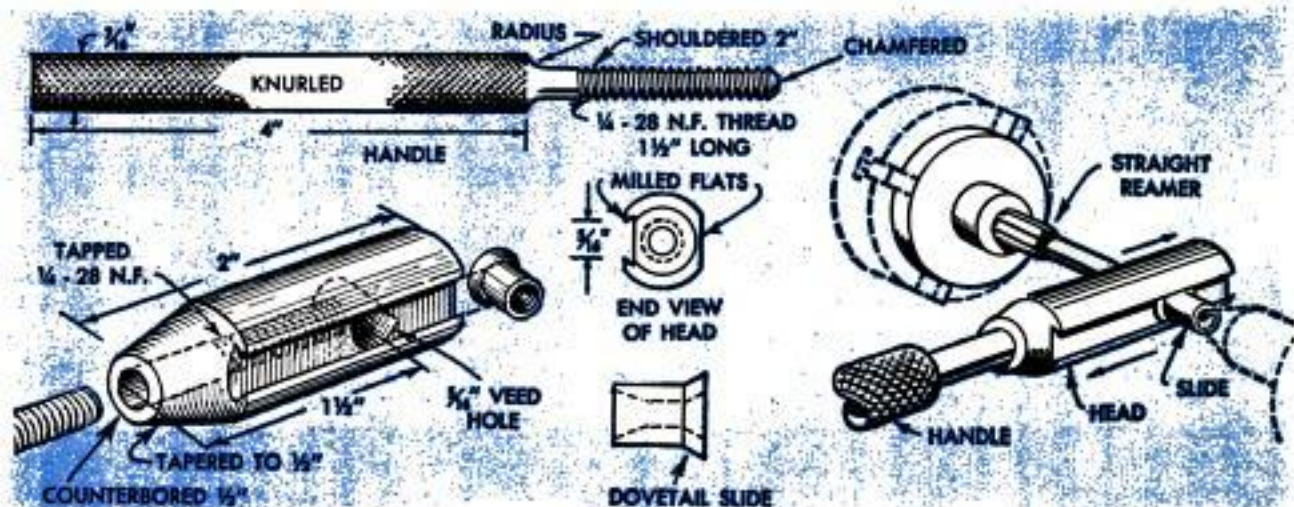

Constant Water Supply for Poultry Provided by Cistern and Pump

One poultryman assured himself a constant supply of water for his flock by building a cistern under the floor of the poultry house. All downspouts from the gutters on the building lead to the cistern. The latter is capped with a tight-fitting concrete slab and a well pump is provided for lifting water with a minimum of effort. The watering trough pictured was made from halves of a hot-water tank cut lengthwise and mounted on a wooden stand. Perches were provided on each side. In this case, the troughs were placed near the pump.



Removal of Broken Handle

If you find it impossible to remove the remains of a broken pitchfork handle from the ferrule, push the fork into the ground and apply a blowtorch flame to the wood. This will char the wood so that it can be broken up and removed with a chisel.

SN 56

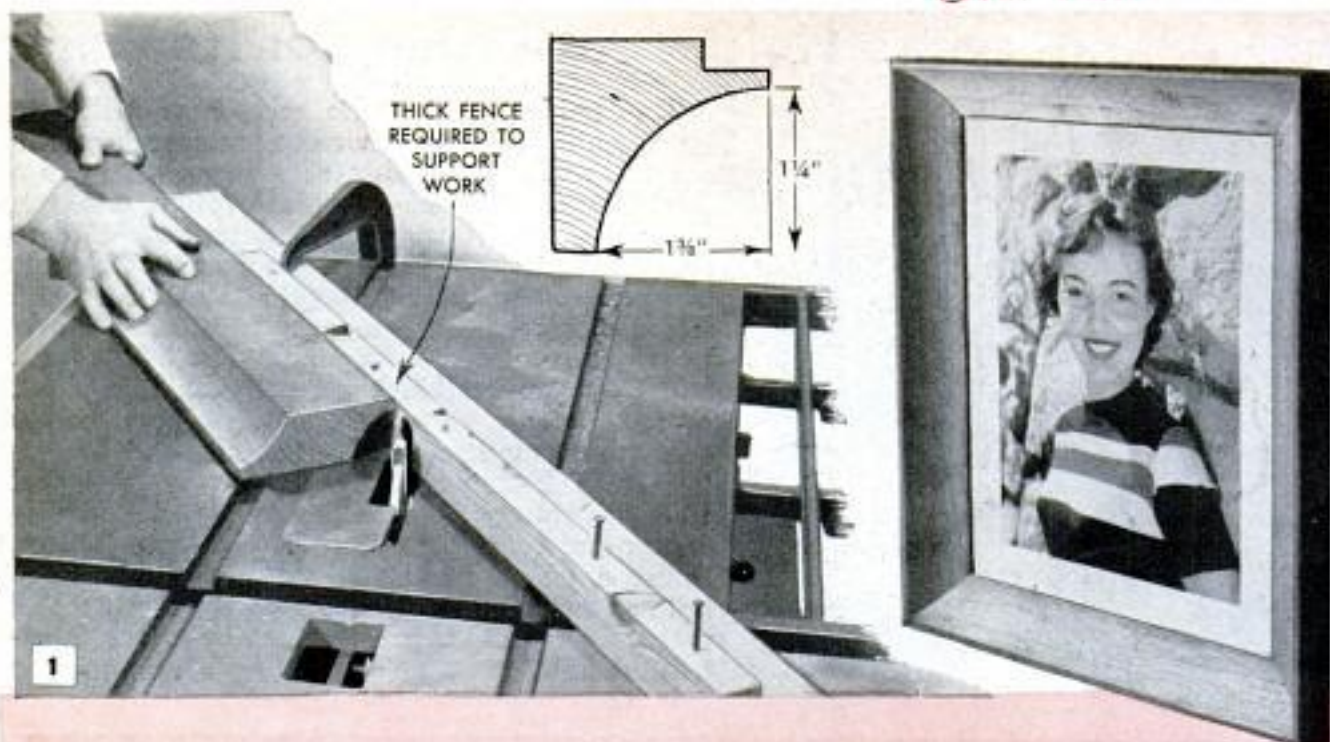

COVE CUTTING ON

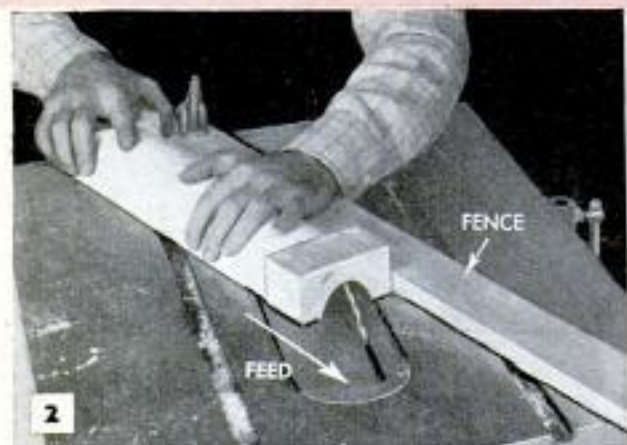

It is practical to use a saw blade for cove cuts up to about 45 deg., as above. The cuts are about $\frac{1}{8}$ in. deep per pass. Below, the molding head is a true cutter and will cut any angle up to 90 deg. With it, cuts can be as deep as $\frac{1}{2}$ in. per pass. The molding head performs better, but the saw can be very useful

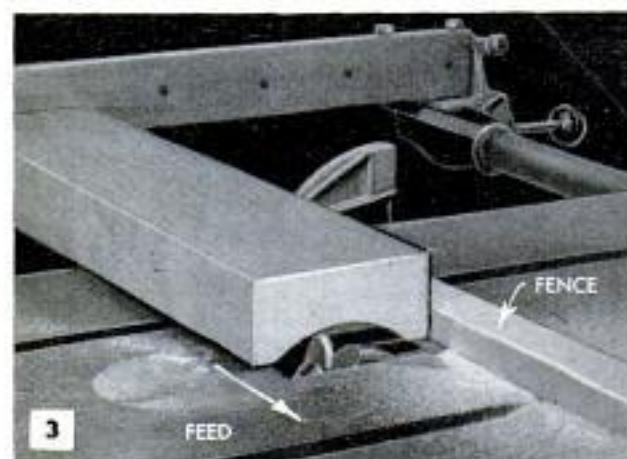

ONE OF THE most novel techniques in circular-saw operation is the oblique feed used for cutting large coves. The actual cutting tool can be either a regular saw blade or a molding head. If a saw blade is used, it should have a medium-wide set, since it is the set of the teeth which enable it to cut when the work is fed at an angle. The molding head is a better performer, being a true cutting tool, and capable of biting off a $\frac{1}{2}$ -in. cut per pass, whereas the depth of cut per pass with a saw is only about $\frac{1}{8}$ in. However, the saw blade can be useful in cutting very large shapes.

Every cut made with oblique feed is part of a true ellipse. The diagram in Fig. 12 shows the range of cuts possible with a 6-in. molding head. The molding head will cut work at any angle up to a direct 90-deg. cross-feed, Fig. 3. The saw blade is practical to about a 45-deg. angle, Fig. 2. Cuts can be made with the cutter or table tilted, as shown in Figs. 10 and 11, to produce large scotia moldings.

The first step in using an oblique feed is to make a setting-out frame, left-hand detail, Fig. 4, with an inside span equal to the width of the desired ellipse. The example in Fig. 1 is a half-ellipse, making the full shape $2\frac{3}{4}$ in. wide, which is the width of the frame, as shown in the detail in Fig. 4. Put the frame over the cutter and then twist the frame until the cutter just nicks both of the inside edges, as shown. The

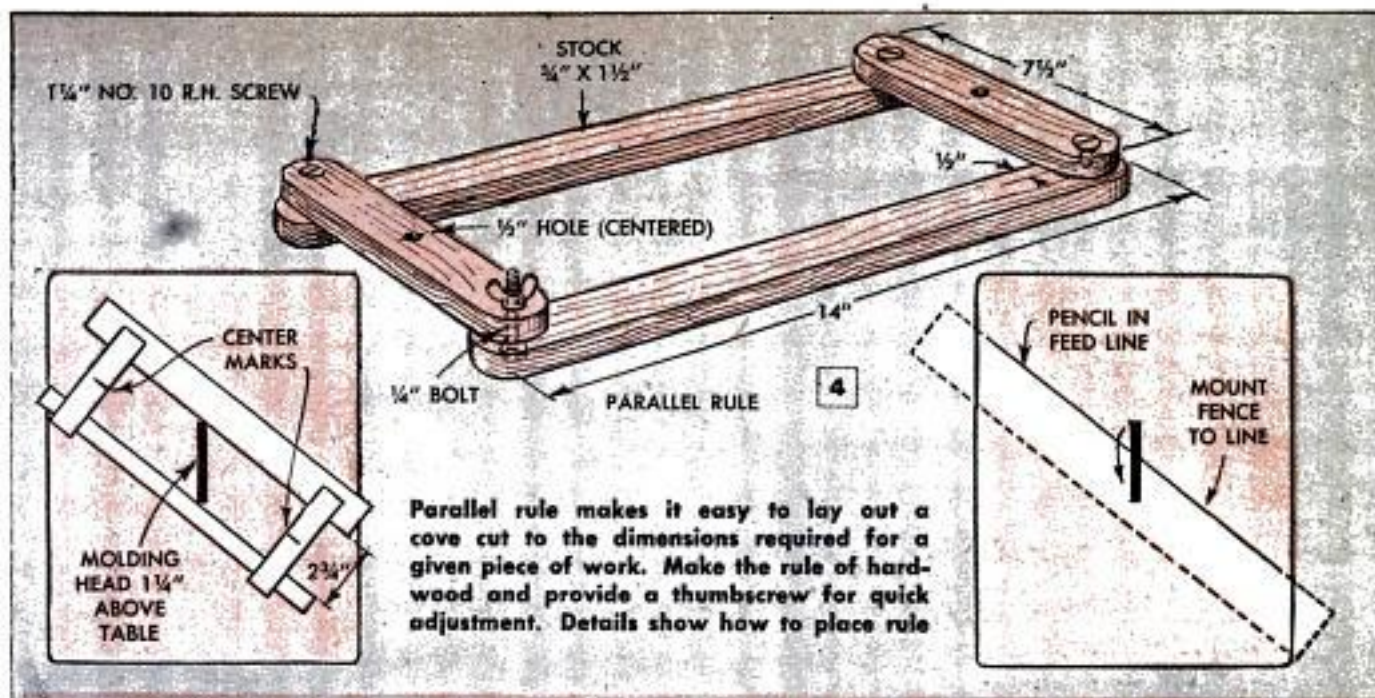

THE CIRCULAR SAW

projection of the cutter when doing this should be equal to the required depth of cove which, in Fig. 1, is 1 1/4 in. With the frame in position, it is a simple matter to make pencil marks to locate the feed line, shown in the detail, which is marked on the saw table. If you do much cove cutting, the parallel rule, Fig. 4, is useful as it can be set to any desired width. The 1/2-in. holes in the crossbars are always centered and will locate the feed line so that it is centered with the molding head.

The rest of the job is simply a matter of clamping a guide fence alongside the feed line and making the cut. Note that the fence must be held high enough to support the uncut portion of the work. Three or four passes will cut the full shape, with

the final cut being a light one for a smooth finish. Molding-head work requires no sanding. If desired, the cut can be made on the far side of the work, as is being done in Fig. 5. This is often advantageous, since it permits a low fence. When the feed line makes an angle greater than 30 deg. with the saw blade, the miter gauge fitted with a wood facing can be used as a guide fence, as in Fig. 6. This is the handiest setup and should be used when possible.

A half circle cut is set by placing the center line over the feed line, as in Fig. 7. When a cove cut is required on narrow end grain, the work should be supported with a backing block, as shown in Fig. 8, to assure a safe, smooth feed. Also, in common with the same operation done on other

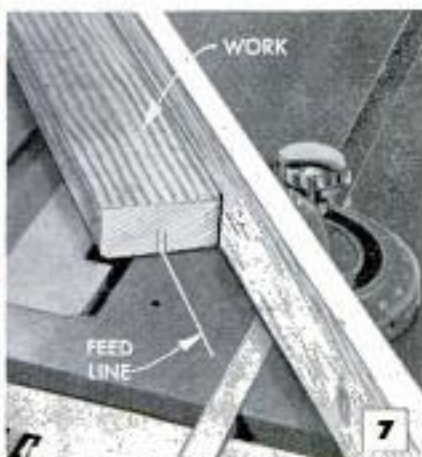
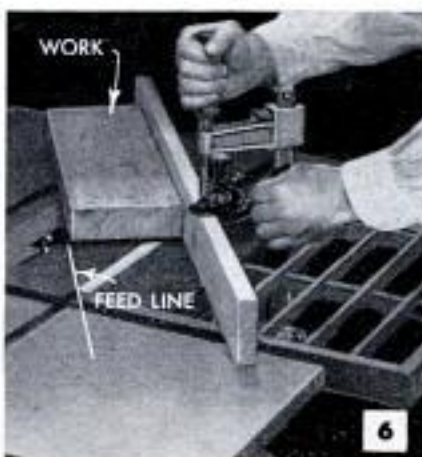

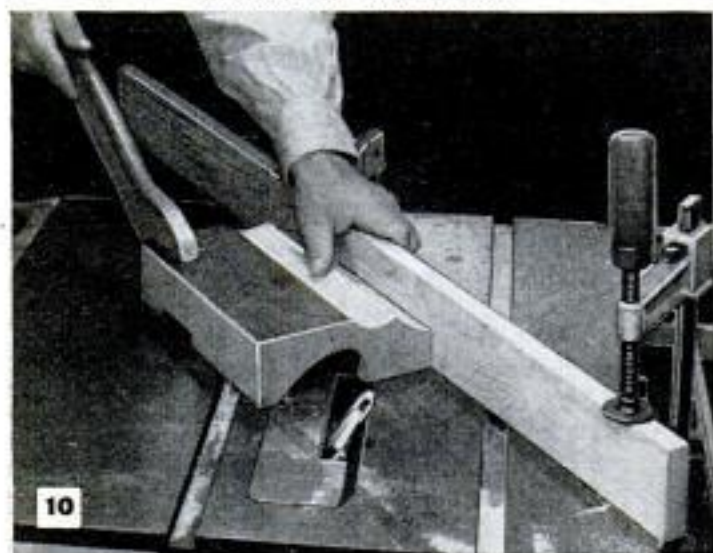
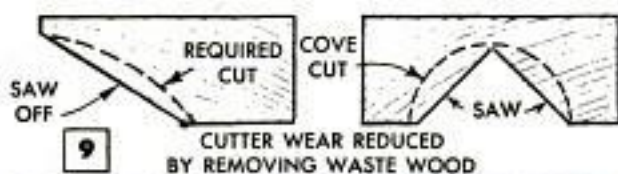
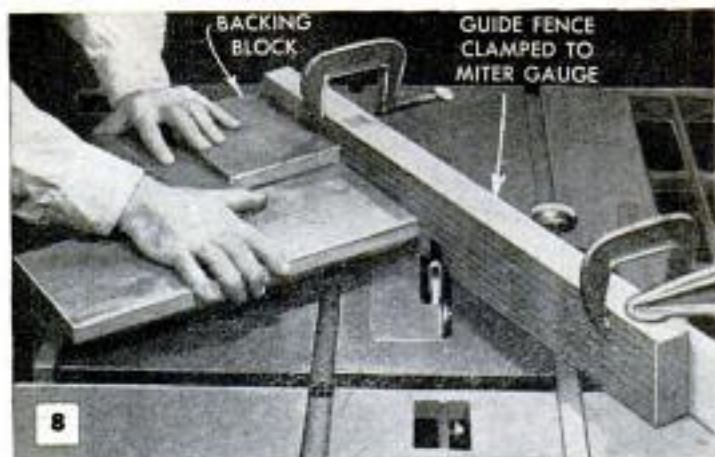

Cuts can be made with either the cutter or the table tilted. For angle cuts, sketch shape from diagram below on tracing paper and then draw the work shape over it at a suitable angle. The angle as drawn is the tilt angle, as shown to the right

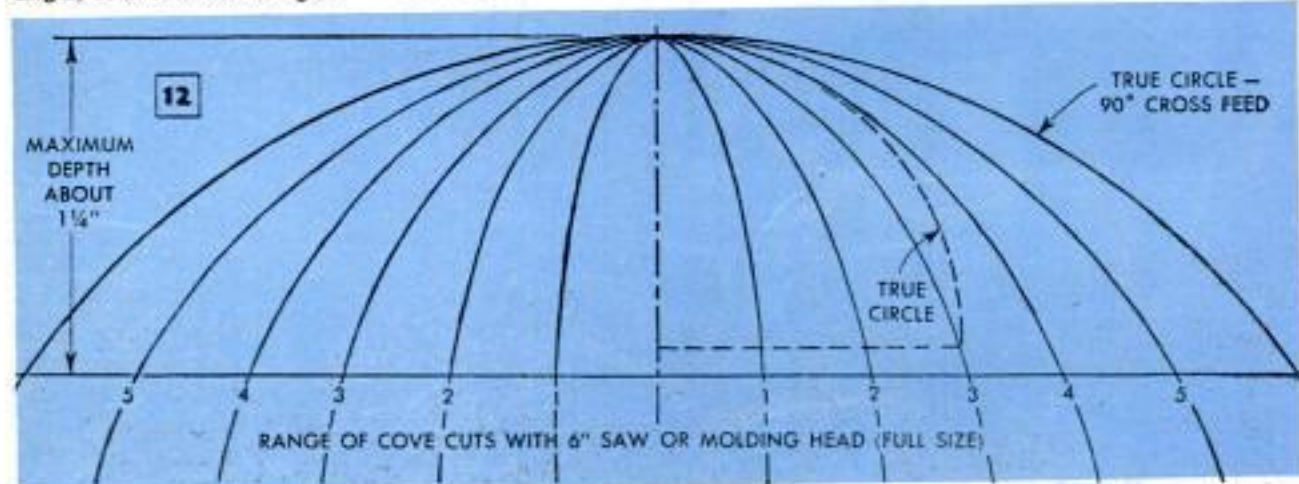
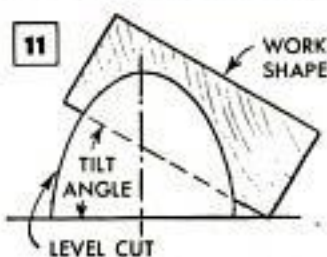

tools, the end-grain cuts should be made first so that slight grain tearing at the end of a cut will be cleaned by succeeding with-the-grain cuts. Smoother work with less cutter wear is possible if some of the surplus wood is sawed away, as illustrated in Fig. 9.

An angle cut, Fig. 11, is just as easy to make as a level cut. To determine a suitable shape, sketch on tracing paper any ellipse from the diagram in Fig. 12, and then draw the work shape over it at a suitable angle. The angle as drawn is the tilt angle. Setting-out is done in the same manner as for a level cut.

One of the most important uses of the cove cut is in making the inside round for round corner blocks. The external shape is worked by turning a four-square assembly in the lathe, Figs. 13 and 14, after which the inside cut is made by using oblique feed. If you want to cut a cove on circular work, determine the feed line as for a straight piece of work, and then locate a pivot point by drawing a line at right angles to the feed line, as shown in Fig. 15. The pivot arrangement itself can be any of several setups, the example in Fig. 16 being a wood block nailed to a wooden strip which is clamped to the wood facing of the miter gauge.

A unique job done with the oblique feed is the spiral cove. This is done by first sawing a spiral on the work, as in Figs. 17 and 18, letting the work rotate as it is pushed lightly along the guide fence. For this work, the saw blade is exposed $\frac{3}{16}$ in., with the miter gauge set at 73 deg. Then, with the miter gauge swung to the opposite side of center, the saw cut engages a guide pin to make the cove cut, Figs. 19 and 20. In the phantom view, Fig. 20, note the location of the pin in relation to the saw blade. ★ ★ ★

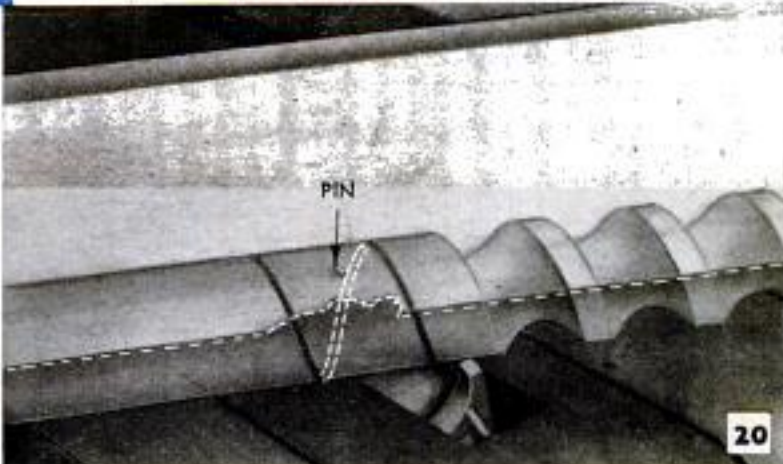
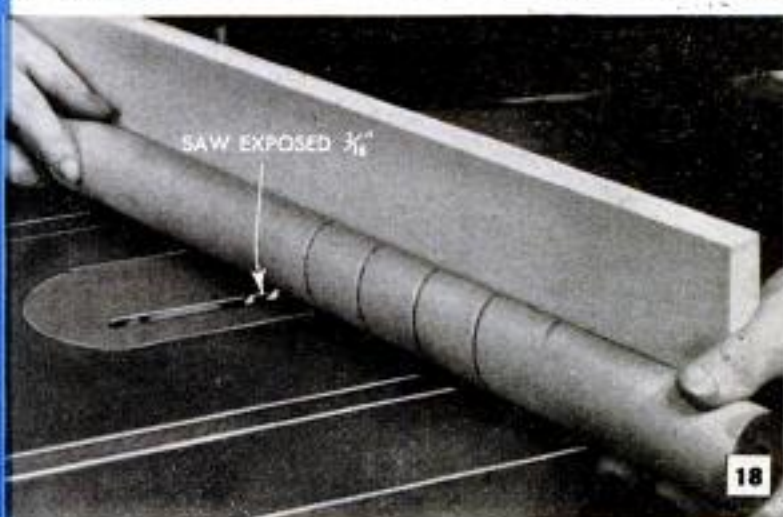
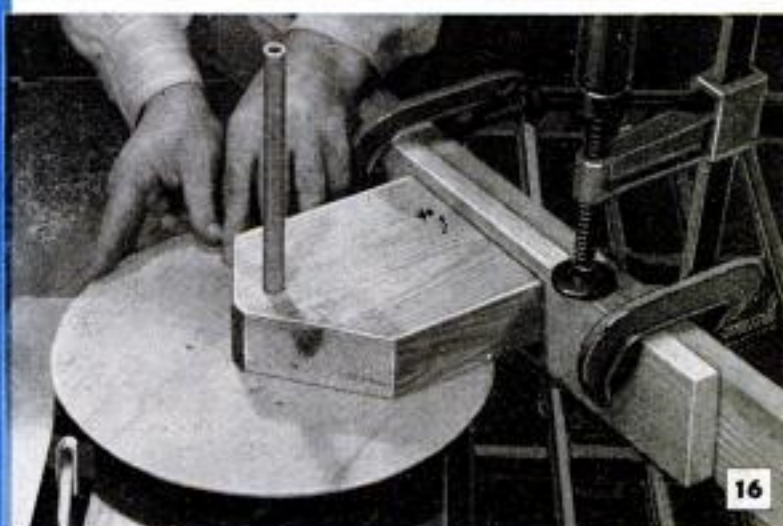
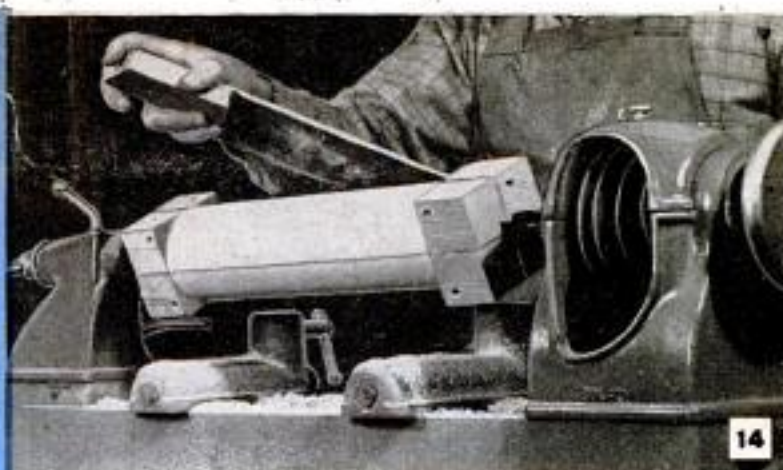
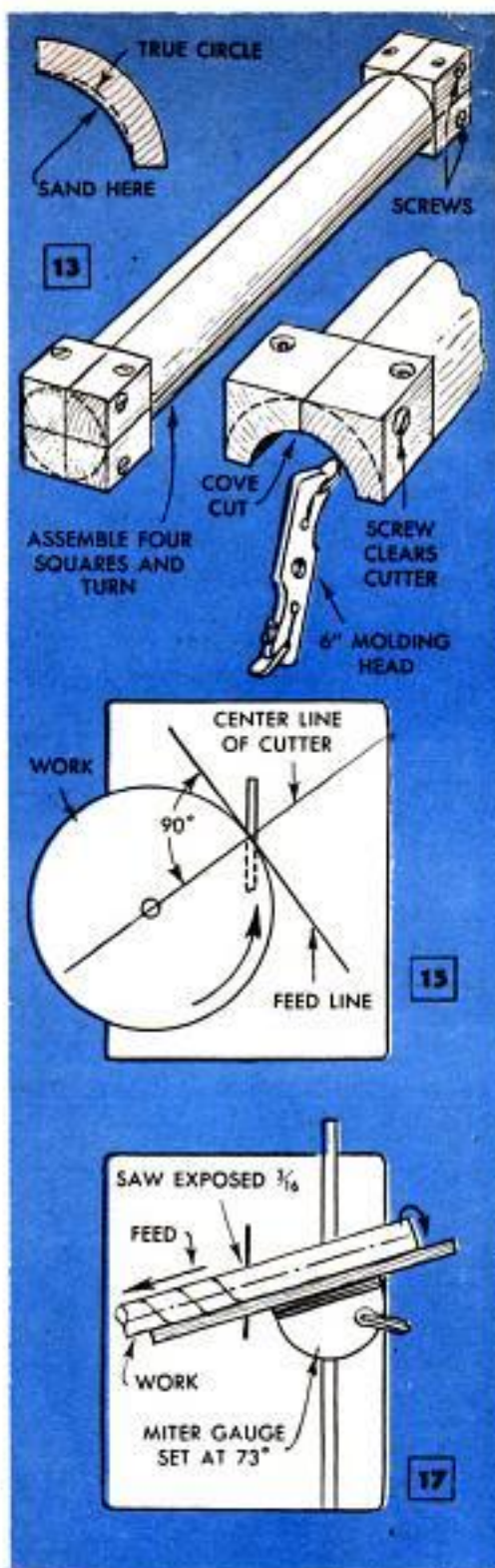



Intercom Between House and Barn

Because he spends at least 60 percent of his working time in the barn which is 200 ft. from the house, one dairy farmer has installed a two-way intercommunication system between the two buildings. Telephone calls and other information received at the house are immediately relayed to the barn via the system and are as quickly answered. The units of the system are battery-powered and connected by a two-wire cable.

Stop-Light Switch on Car Dash Provides Rear "Fog Light"

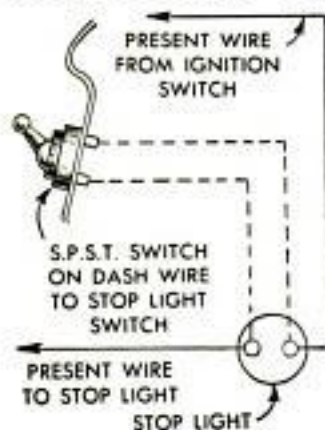

An extra-bright taillight, which will furnish a safety precaution when driving in heavy fog, can be provided by a switch that allows continuous burning of the stop-light bulb. A single-pole toggle switch is mounted on the dashboard and wired in parallel with the stop-light switch. When the switch is turned to the "on" position it will shunt out the regular stop-light switch and permit the one stop light to burn continuously. This idea is especially useful on older cars that have small, dim taillights. Note

that this idea should be used only on cars having two taillights. One stop light is wired to burn continuously while the other flashes on application of the brake.

Fred Lettino, Astoria, N. Y.

Ground Rod Reinforced by Pipe

To prevent a long electric ground rod from wavering and bending when driving it into hard or stony ground, first force a short pipe into the ground and insert the rod. When the rod has been driven in several feet, the pipe is removed and the job finished without further difficulty.

Faceplate-Center Indicator Speeds Job Setup

A faceplate-center indicator will aid in centering irregular-shaped work in the lathe when the center hole of the faceplate is hidden. The indicator is made according to the dimensions given in the detail, with the exception that the length of the support arm will vary according to the diameter of the faceplate being used. The pointer is shaped and ground from a length of drill rod while the rest of the indicator is cut from cold-rolled steel. To use the indicator, remove the faceplate from the lathe and place it flat on the bench. Hold the indicator against the edge of the faceplate, center the work and clamp it tightly. When the faceplate is remounted on the lathe, the work will require only a slight tap or two to run dead true.—C. W. Woodson, Chicago.

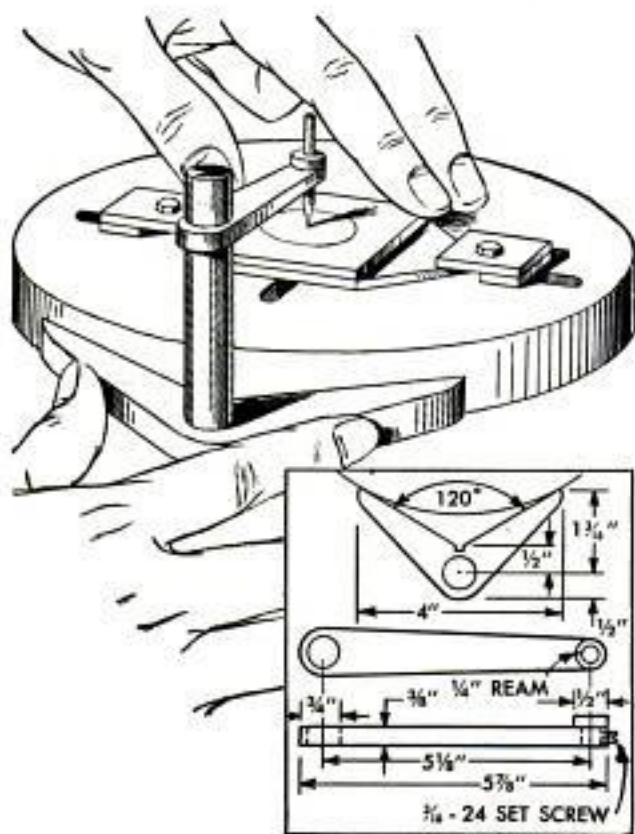

SN 56

selecting and using a

BENCH VISE

By E. R. Haan

WHEN SHAPING PARTS of wood or metal with ordinary hand tools it is impractical if not impossible to work without a bench vise. There are many types of vises, varying in size and application, but all are dual-purpose clamping and holding tools. Two of the most common, especially in the home workshop, are the clamp-on vise and the rapid-acting woodworking vise, both shown in Fig. 1. The first clamps to any table or bench top and comes in jaw sizes ranging from 1½ to 3 in. It is suitable for light work. The rapid-acting vise has full-depth jaws and a splined screw which permits the movable jaw to be drawn out to the full opening without turning the handle. The screw is engaged or released at any point within the full opening simply by turning the handle left or right. The full-depth jaws adapt this vise to clamping wood without denting or marring. It is also available in single-acting type having a continuous screw. Figs. 2 and 3 show several applications of the rapid-acting vise on a bench. Fig. 4 shows an underneath view of this vise and the manner of attaching it to the bench. Fig. 5 details a support which comes in handy for supporting long boards held in the bench vise for jointing. One end of the board rests on the pin, which can be inserted in holes drilled in the bench leg at different heights.

The right-angle vise, or clamp, shown in Fig. 6 is made especially for clamping the

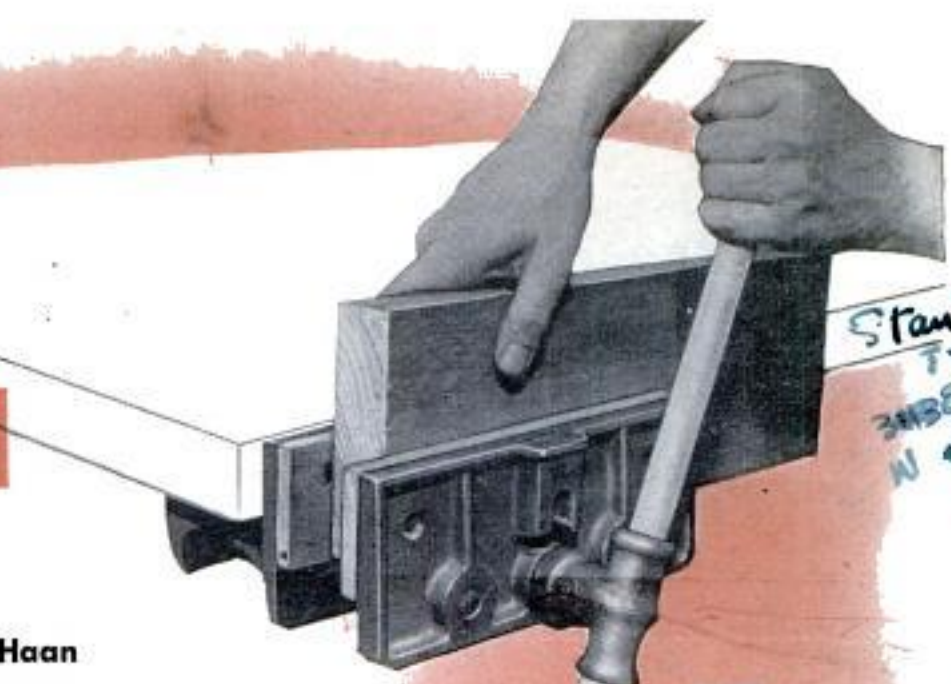

Stanley
Type
21821 m 56
N 4 1/2 in. jaw

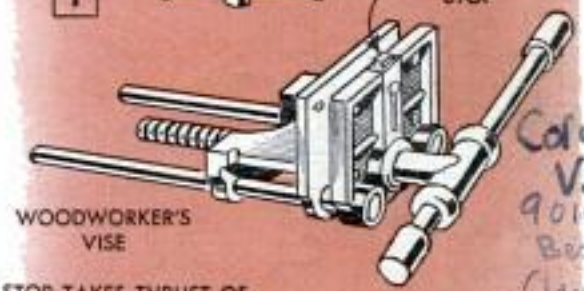
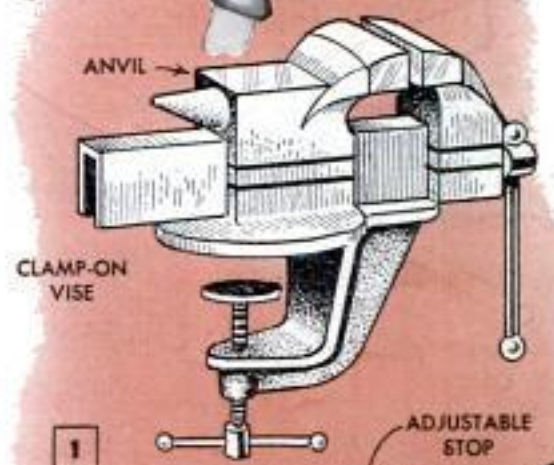

Columbia
Vise Co.
9015
Ber
Cle
O.V.M.

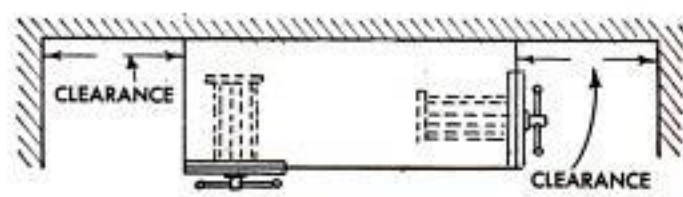
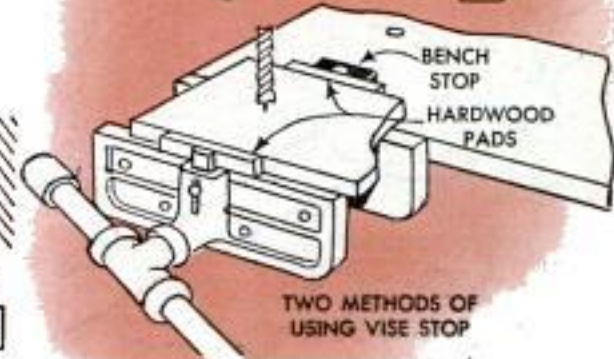

WOODWORKER'S VISES ARRANGED AT ENDS OF BENCH 3

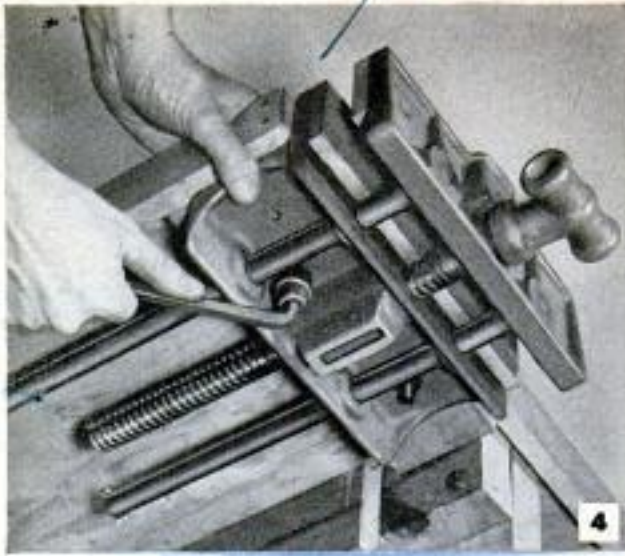

4

mitered corners of picture frames but is adapted to other operations requiring the clamping of mitered stock. The jaws open to approximately 3 in. and the unit tilts from the horizontal to the vertical position.

Fig. 7 pictures one general type of the machinist's vise, an indispensable bench tool in machine shops, tool rooms and experimental laboratories. Machinists' vises have swivel bases which permit the unit to be swung to any position convenient to the user when working from the front or end of the bench. Nearly all sizes are fitted with removable jaw inserts. Frames and jaws are exceptionally heavy and are designed to withstand extreme pressures. Nearly all sizes have a small built-in anvil or flat hardened surface for light hammering necessary when shaping or assembling small parts.

The drill-press vise is something special as you will see from Fig. 8. The sides of the frame are milled parallel and at right angles to the bottom. Both fixed and movable jaws are finished on the sides and faces. It is furnished as a plain unit with a separate V-block insert, also on a swivel base as pictured and in a universal type which provides both a swiveling and angular adjustment. The bases are slotted and finished smooth on the bottom for bolting to the drill-press table. Another type, quite commonly used in pairs, consists of a long bar on which are mounted fixed and movable jaws capable of a wide range of adjustment. It is especially useful on the drill-press table for holding wide, flat work for drilling at various points on the surface. When used either singly or in pairs the unit is easily attached to the drill-press table.

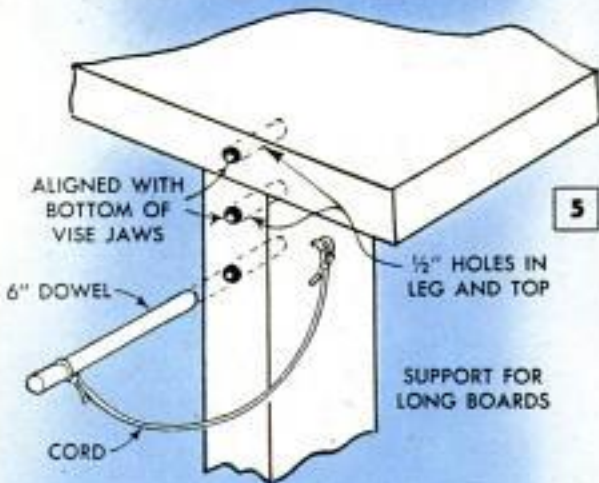

5

Stanley
E

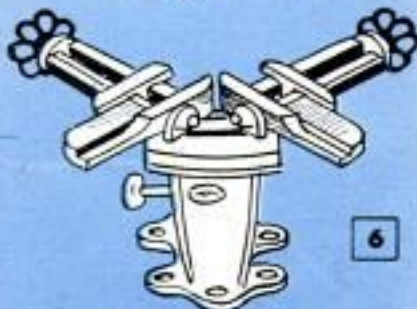

6

MITER VISE (FOR PICTURE FRAMING)

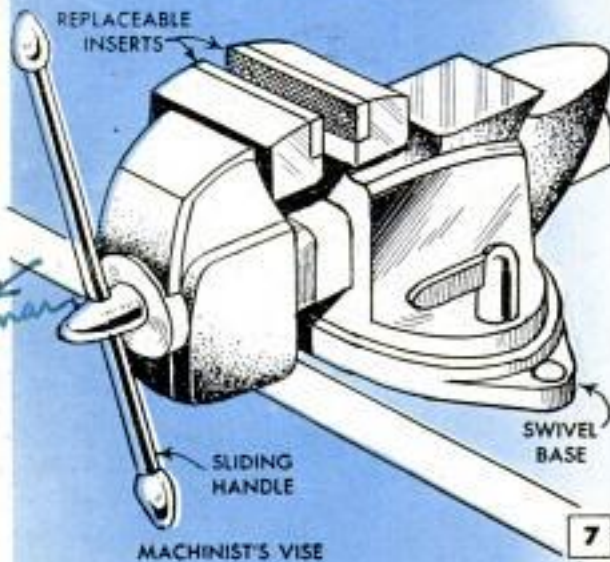

7

MACHINIST'S VISE

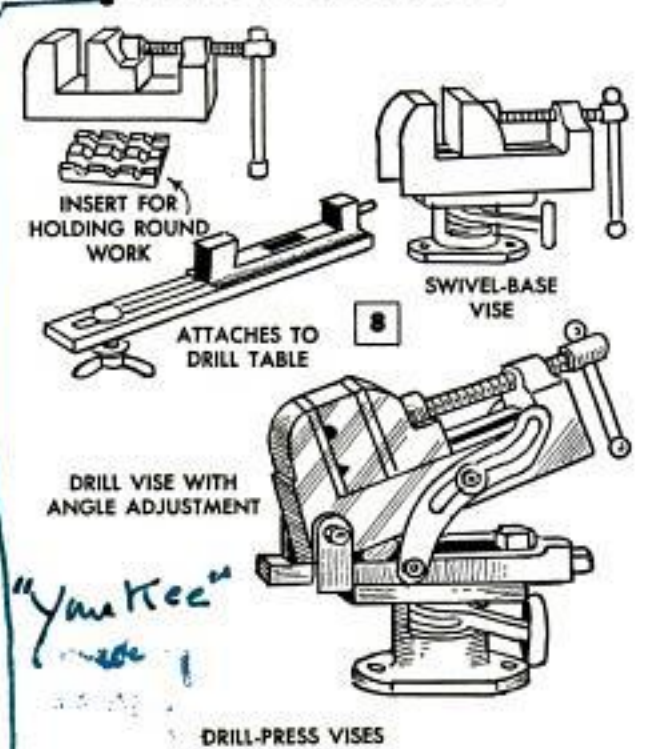

8

SWIVEL-BASE VISE

DRILL VISE WITH ANGLE ADJUSTMENT

"Yankee"
made

DRILL-PRESS VISES

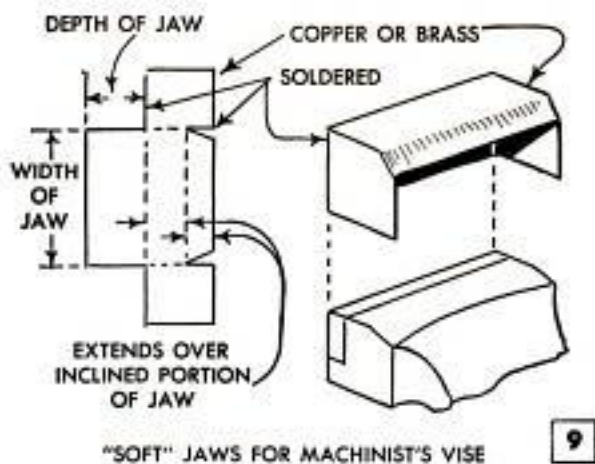

"SOFT" JAWS FOR MACHINIST'S VISE

When holding finished work in the vise for some final operation, machinists and diemakers often provide "soft" jaw faces to prevent defacing the work. These usually are made as in Fig. 9 from softer metals such as copper, brass or aluminum. They should fit the jaws snugly so that they will stay in place while in use, yet should be easily removable when not required.

Pipe jaws of both the removable and integral types are furnished with several types of bench vises, Fig. 10. These are especially useful in the home shop where limited use will not justify the purchase of the standard pipe vise. However, if your present vise does not have pipe jaws you can still make use of it as in Fig. 11. The setup is simple, utilizing a pipe wrench as the pipe jaws, the vise merely serving to hold the pipe in position. Two types of standard pipe vises are shown in Fig. 12, one the chain type familiar to all plumbers and the other the self-locking vise which is available in a variety of sizes.

One thing to remember when bending metal in any type of vise: Always make the bend against the stationary jaw as in Fig. 13, never against the movable jaw as you may damage the screw, especially if hammer blows are necessary in making the bend against the stationary jaw, never against the movable jaw as you may damage the screw, especially if hammer blows are necessary in making the bend. When you cut angle stock, such as angle steel, aluminum and brass in various sizes, lock it in the vise jaws as in Fig. 13 with the web of the angle over the stationary jaw as pictured. The point of cut should be as close as possible to the end of the jaw so that there is adequate support, as pressure of sawing is against the stationary jaw. In this position the saw can be started on the flat side of the web instead of the edge, making it easier to start the blade straight and at the same time avoiding any chance of breakage. Vise pictured is the machinist's type having a swiveling base. ★ ★ ★

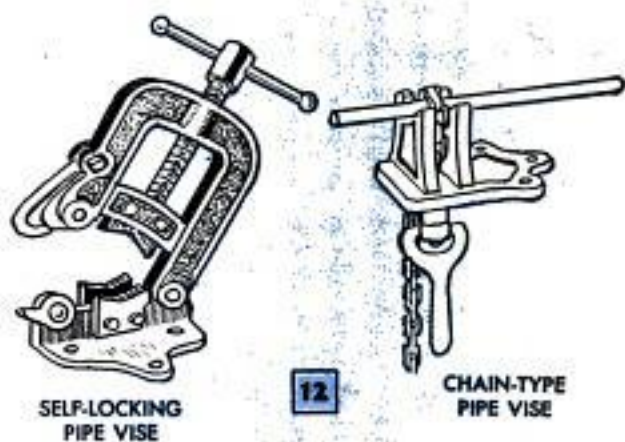
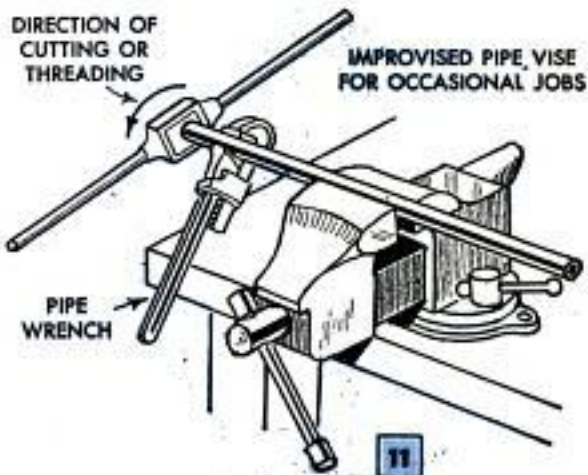
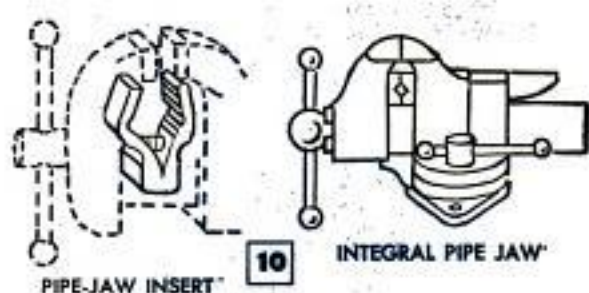

Automatic Cutoff on Water Pump Prevents Overfilling Tank



To permit a stock-watering tank to be filled to the desired level without attention, one farmer rigged an automatic shutoff for the gasoline engine that drove the pump. An insulated ground wire runs from the spark plug of the engine to an insulator fastened to the inside of the tank at the required depth. When the water rises in the tank and contacts the bare end of the wire, it shorts out the spark plug and the engine stops.

Push Stick for Bench Saw

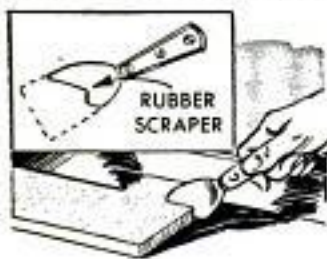

To avoid the problem of having a push stick used on a bench saw split or slip on the work, make one from a rubber plate scraper or mixing paddle. Cut

away the rubber blade as indicated in the detail. Be sure the handle is securely fastened to the blade with rivets or screws; the handles of some mixing paddles are merely forced into the blade and will pull out easily.

Replacing Broken Car-Hinge Pin

When a car door is out of line or has become loosened, a worn or broken hinge pin sometimes is indicated. One way of replacing the pin is to use the stem of an old engine valve. Just cut or grind off the head and then grind down the opposite end to a

shape similar to the common nailhead.—John H. Jacobsmeier, Jr., Holloman Air Force Base, N. Mex.

"Bumper" on Drill-Press Column Protects Operator Against Injury

A thick rubber washer bolted to the column of a drill press will prevent a possible broken toe or smashed foot caused by the drill-press table being dropped when the lockbolt is loosened. At a point a few inches above the floor,

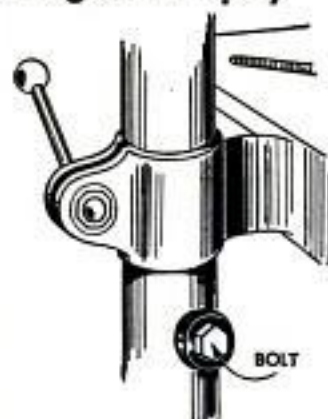

drill and tap a hole for a stud bolt to hold the washer in place. If the thickness of the wall of a hollow column does not permit threading, run the hole all the way through the column and use a bolt long enough to extend through the column. A rubber washer then is fitted under both the nut and the head of the bolt.—N. C. Dickey, Johannesburg, South Africa.

Concrete Apron of Machine Shed Used as Outdoor Workshop

A level concrete apron, the width of the machine shed, combines the advantages of providing an all-weather entry to the shed with an outdoor shop floor. Large machinery can be towed onto the concrete for emergency repairs, thus eliminating the necessity of dismantling the machinery and wheeling it into the shed. This leaves more room in the workshop for servicing operations and maintenance work.



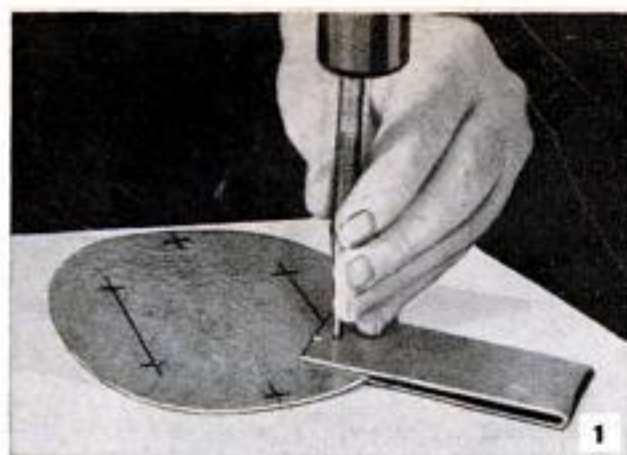

RIVET IT RIGHT

By Sam Brown

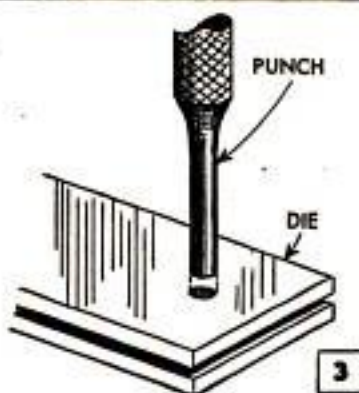

RIVETING IS ONE of the simplest and most practical methods of joining sheet metal and lightweight flat stock. In addition to forming a strong joint, riveting also provides a decorative feature which frequently adds to the appearance of the project.

Rivets: The size of rivet normally used in craftwork ranges from $\frac{1}{32}$ to $\frac{1}{8}$ in. in diameter and $\frac{1}{8}$ to $\frac{1}{2}$ in. in length. The single, most useful rivet for sheet-metal work is a roundheaded rivet, Fig. 6, which is $\frac{3}{32}$ in. long and $\frac{1}{4}$ in. in diameter. Also

handy to have around are $\frac{1}{16}$ and $\frac{1}{8}$ -in.-dia. rivets, the smaller ones being $\frac{1}{8}$ in. long. Rivet mixes, which probably are available from your local hardware dealer, include a wide variety of head shapes and solid, hollow, one-end hollow and split shanks.

Riveting: A flat-formed head, shown in Fig. 5, is the most common type of formed head, or upset. This is done with any hammer having a flat face and always with light hammer taps to get a true peening action without deforming the shank of the





7

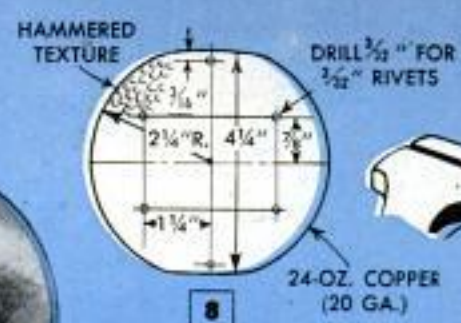

CIGARETTE SERVER

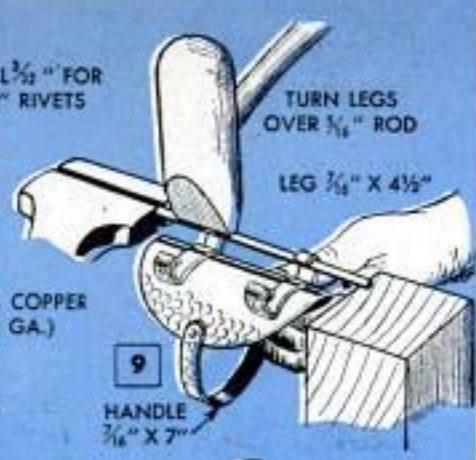

9

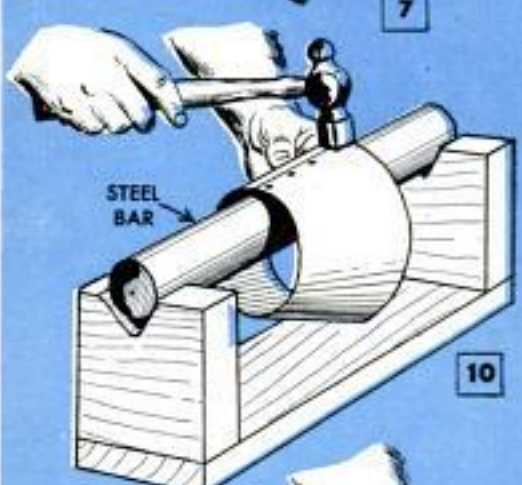

10

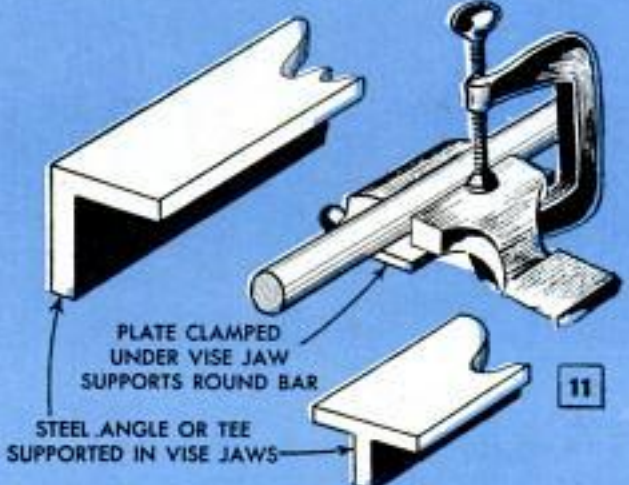

11

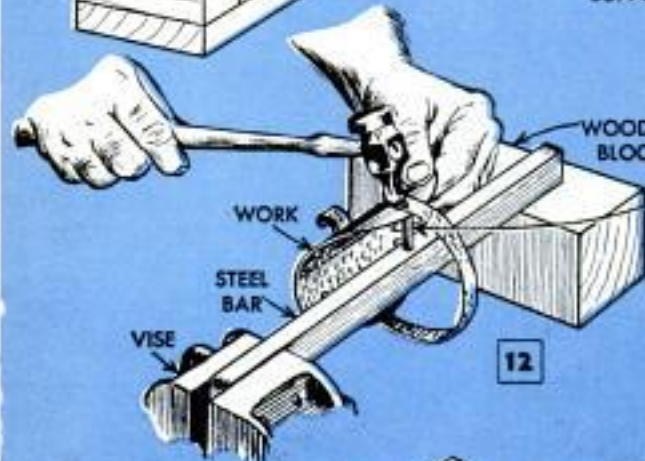

12

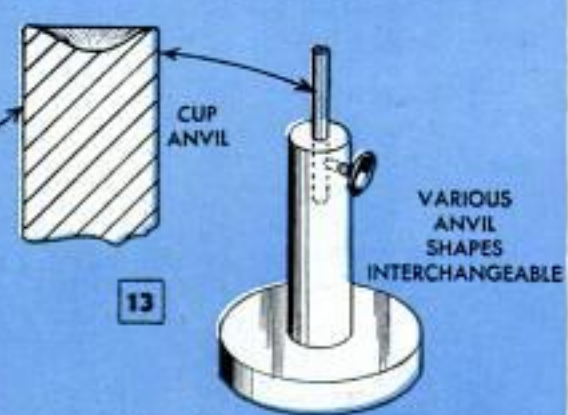

13

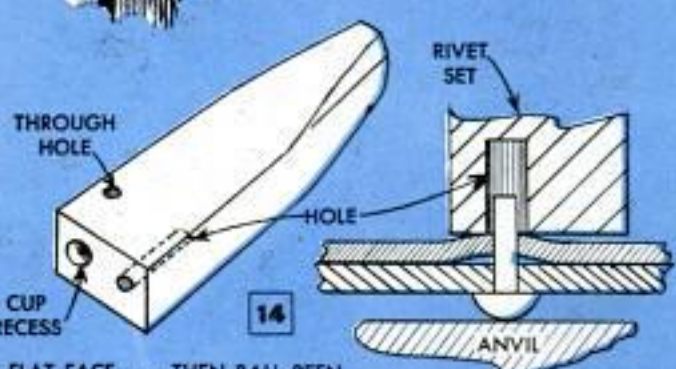

14

USE FLAT FACE . . . THEN BALL PEEN

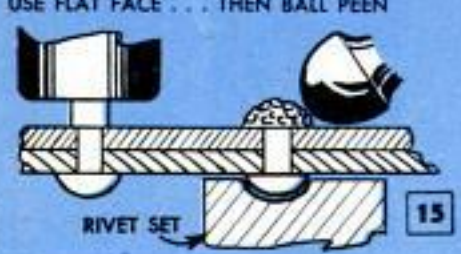

15



16

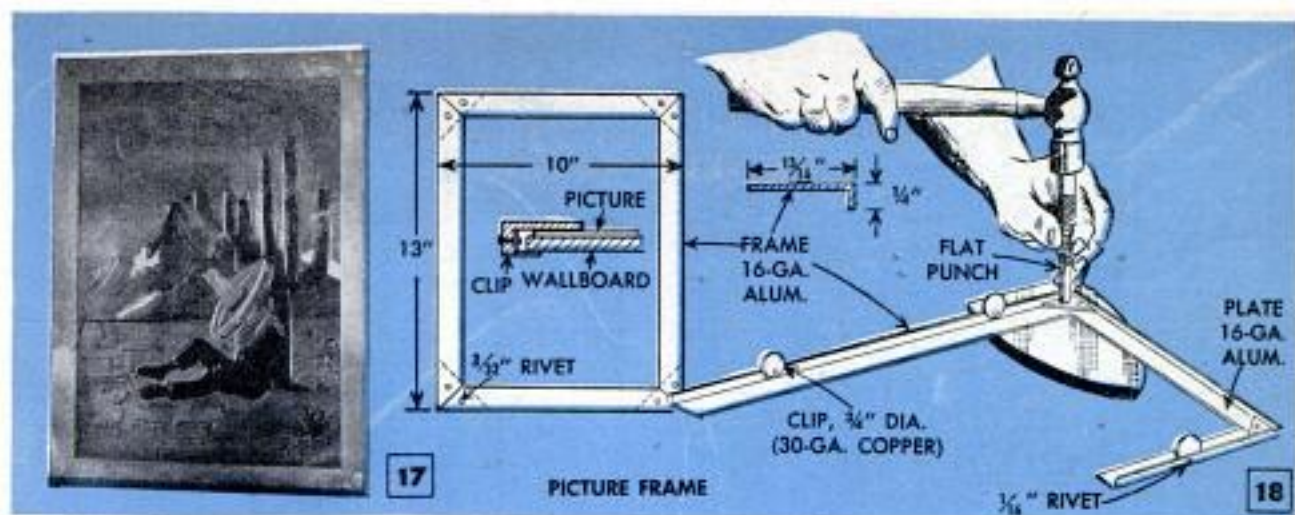

rivet. The hammer face should be well polished to impart a similar polish to the surface of the rivet head. If you want a round head, start by flattening the rivet slightly as in Fig. 15. Then strike the flattened rivet around the edges with a small ball-peen hammer. The surface on which riveting is done usually is a polished metal anvil. The sole plate from a discarded electric iron may be used for this purpose as in Fig. 18. The anvil will tend to flatten the round head of the rivet, but the effect is attractive. If you want to preserve the round head of the rivet, support it on a surface that is softer than the rivet but hard enough to keep the rivet from being driven back through the work. Use hardwood backing for aluminum, sheet aluminum over wood for copper and brass and solid aluminum or copper for iron rivets. Another way to preserve the round head is to use a cup anvil as shown in Fig. 13. The cup recess is one of the features of a rivet set, Fig. 14. Besides being used to support the rivet as an anvil, the rivet set can be

used to form a round head after rough hammering as in Fig. 6. The plain holes in the rivet set merely slip over the rivet to permit drawing the two parts tightly together before upsetting the rivet, as in Fig. 14. After this is done, the projecting shank of the rivet should be cut off with end-cutting nippers, shown in Fig. 5.

Work supports: Once you've started to do riveting work to any extent, it does not take long until you discover that special supports are needed for many jobs. However, the easily made fixtures shown in Figs. 9 to 13 inclusive and Fig. 16 will handle most jobs. You also can use most of these fixtures to support the work in the drill press when drilling rivet holes. But for burr-free work, nothing equals a clamp hold-down used in combination with a sheet of metal placed under the work as pictured in Fig. 2. In all cases, burring of the work can be minimized by using a drill which has a point of about 150-deg. included angle. Punching also results in burr-free holes and this can be done with

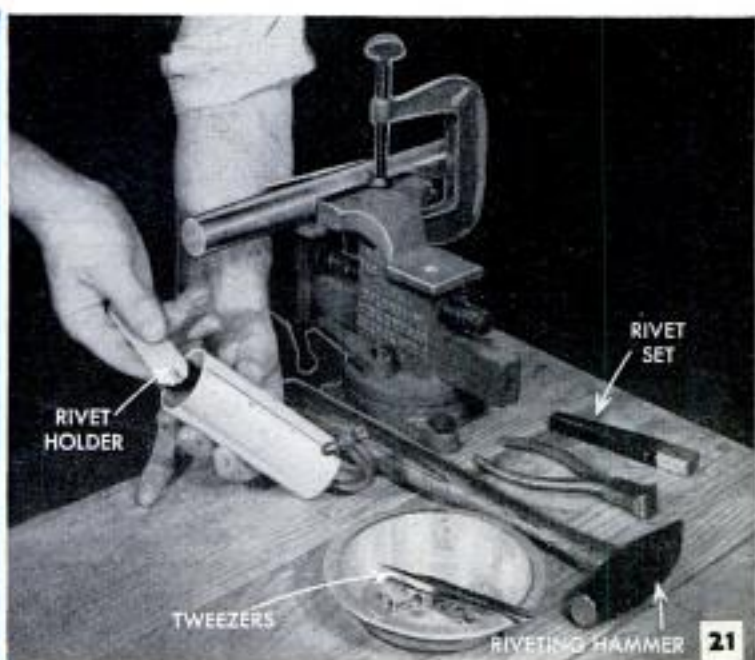
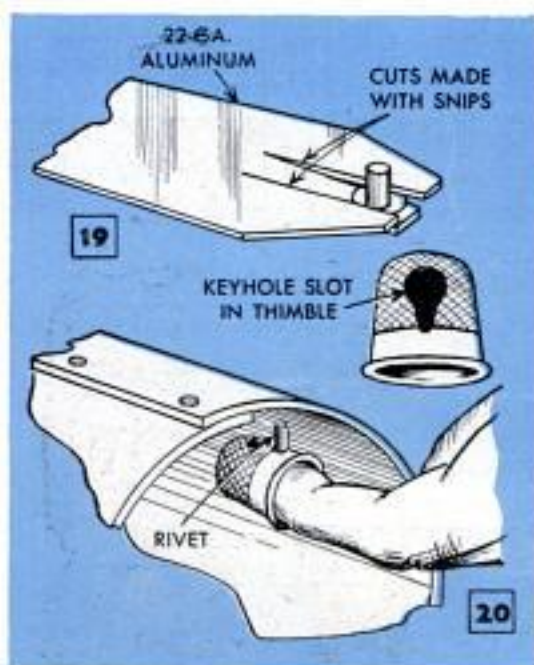

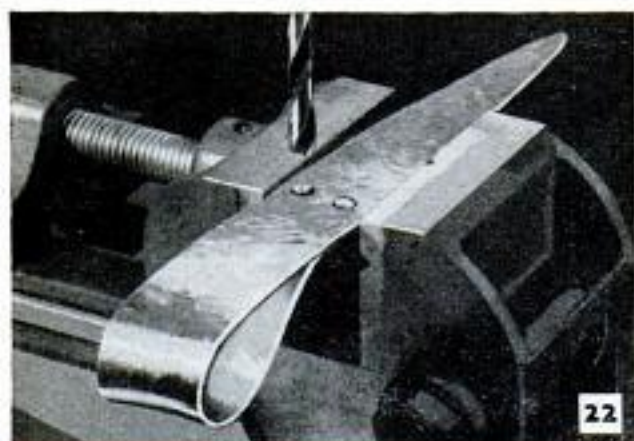

22

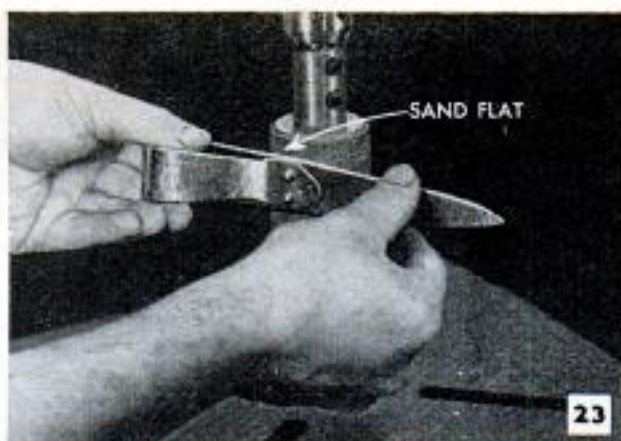

23

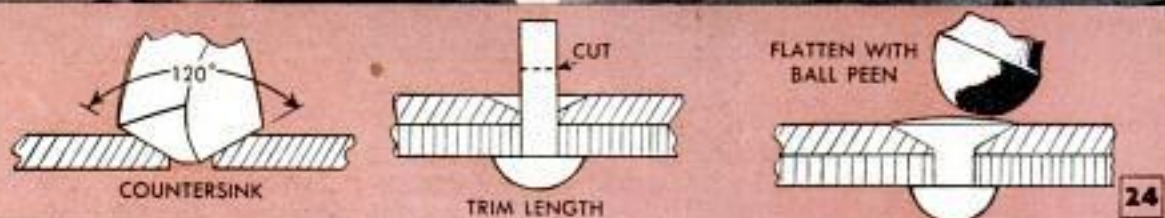

24

a bench punch or with the simple dies shown in Figs. 1 and 3. Fixtures for holding the rivet, Figs. 19 and 20, make it easier to insert the rivet in awkward locations. Fig. 21 shows the tools required for a simple riveting job:

Flush riveting: Flush riveting can be done either by countersinking or dimpling. Countersinking, which is the most common method, is done by using a drill somewhat larger than the rivet hole, as shown in Figs. 22 and 24. After the work is countersunk, the rivet head can be hammered nearly flat and then dressed flush with the surface, Fig. 23. The rivet also can be left crowned if desired. You will notice that projects like the cigarette tray, Figs. 4, 7 and 8, the letter knives, Fig. 25, and the anchor book ends, Figs. 28 to 31, require flush riveting. Another flush-riveting method is called dimpling and is used whenever the metal is too thin to be countersunk. To dimple sheet metal, a die having a countersunk

recess is located under the rivet hole as in Fig. 26. A countersunk-head rivet may be used as a dimpling tool, and this is driven through the work and into the die, countersinking the work as it is driven into place. Figs. 26 and 27 show the spinning method of forming dimples.

Making small rivets: To make a rivet from wire, just drill a hole of the required size through a piece of steel. Set the steel block on top of the vise, insert the wire through the block and clamp the lower end of the wire in the vise jaws, as in Fig. 29. Then peen over the upper end of the wire.

Projects: Of the four riveting projects pictured and detailed on these pages, all are finished bright except for the anchor book ends, Fig. 28, which are oxidized. The letter knife, Fig. 25, is a classic in riveting technique and general art-metal work. The picture frame, Fig. 17, is especially practical for mounting tooled-metal pictures.

★ ★ ★

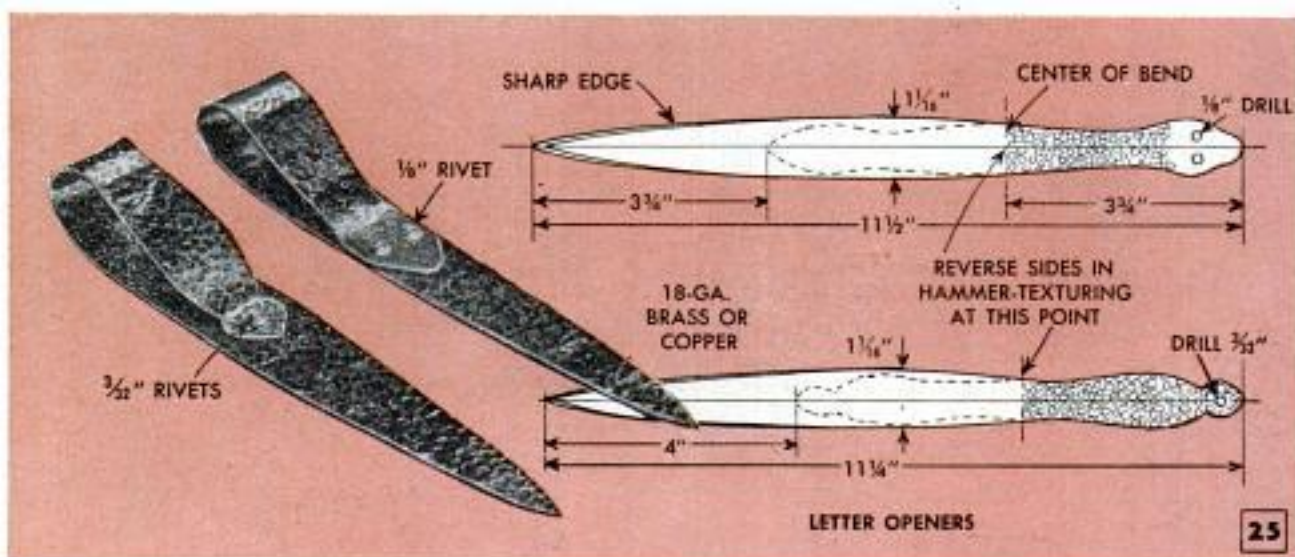

25

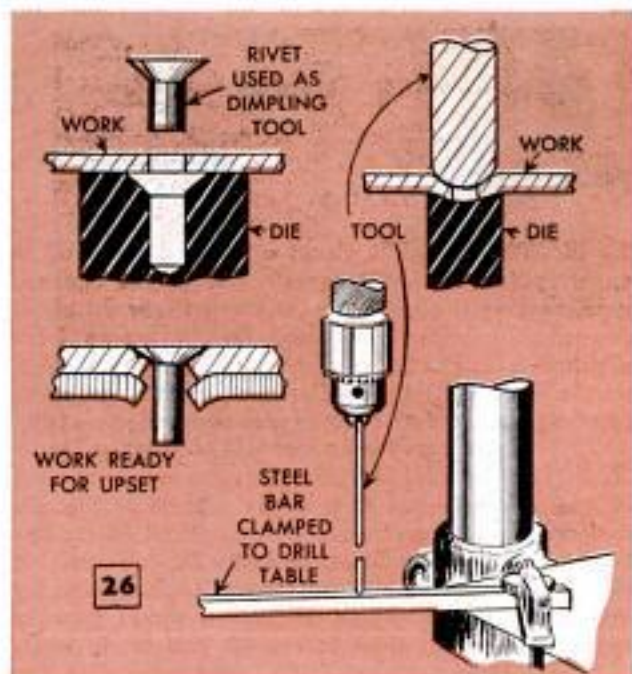

Above, flat-headed rivet can be used as countersink on light sheet metal. Right-hand detail shows alternate method, using round-end drill rod and hole in steel bar



Above, round-end drill rod is chucked in drill press and used to "dimple" rivet hole in light sheet metal. Beeswax is used as lubricant to prevent scoring metal



Photo above and detail and photo below show nautical book ends of riveted construction. Length of twisted wire provides "rope"

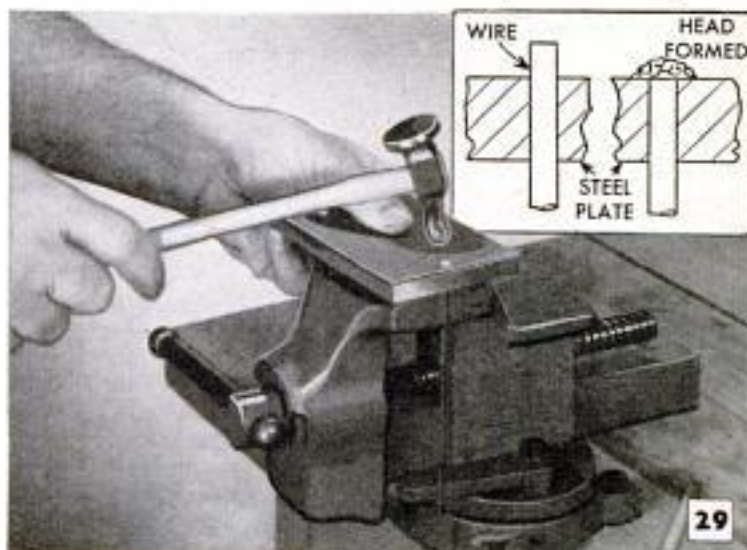

Above, an assortment of rivet wire will furnish rivets of odd lengths and sizes. Wire is clamped in vise and allowed to project through metal-faced wooden block to permit forming head

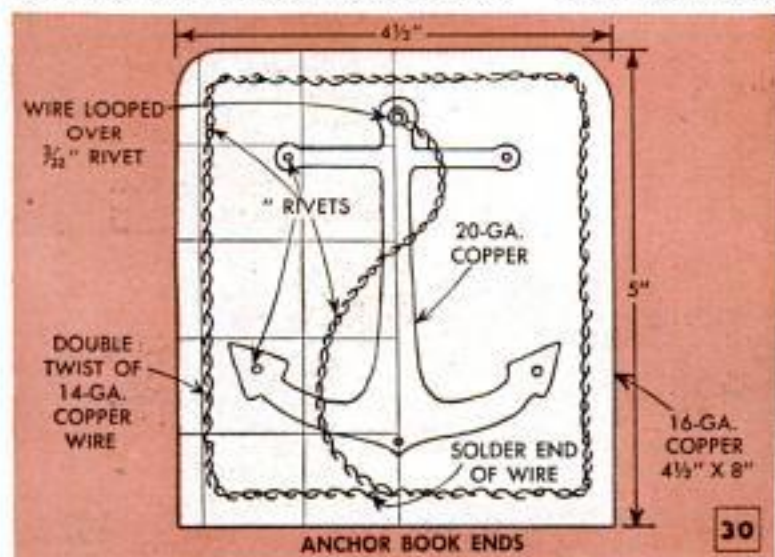

SHOPPING FOR



1



1. LEAKPROOF OILER places a single drop of oil in exact spot desired. Oil container is of the squeeze type, making it possible to control the amount of oil deposited. Lubricant is forced through valve from which it is conducted to the oil cup by means of a needlelike projection rigidly attached to the oiler. Fountain-pen size, oiler comes with cap and pocket clip

The Hughes Co., 8 West 40th St., New York City 18

2

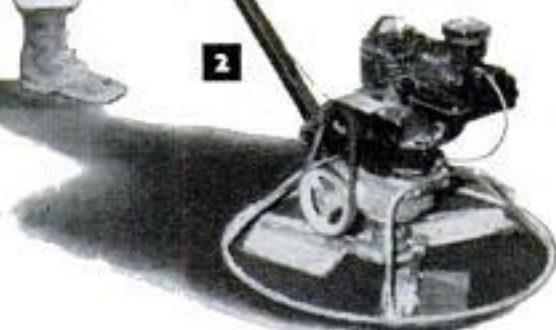

2. POWER-DRIVEN TROWEL takes the hard work out of concrete finishing. It is easily carried to the job and operated by one man. Weighs about 70 lb. Upswept blades cover 24 in. and can be adjusted for floating, smoothing or hard trowel finish. Driven by 1½-hp. air-cooled engine through a worm gear to the blades. Works close in corners and along walls

Master Vibrator Co., 1752 Stanley Ave., Dayton, Ohio

3



3. MOTOR MOUNT is exclusive feature of new line of power tools. It has a new pivoting device which locks automatically in position. Each tool to be motor driven is provided with a mounting bracket and belt-tension rack. Works in either vertical or horizontal position. In mounting, motor rail is slipped into tool bracket. Pivot pin snap-locks it in place

Duro Metal Products Co., 2561 N. Kildare Ave., Chicago 39

4. PORTABLE TREE SAW permits the operator to "walk" through thick underbrush and small trees in land-clearing operations on farms, ranches and nurseries. Cuts trees up to 6-in. dia. within 3 in. of the ground level. Blade can be swiveled to any desired angle for cutting vertically or horizontally. Driven by a 5-hp. air-cooled engine mounted on hand cart

Mall Tool Co., 7740 S. Chicago Ave., Chicago 19



5. PORTABLE ELECTRIC JIGSAW is fitted with a special handle which gives better control and easier operation on hard-to-cut materials such as plastics, hardboards and laminates. Built-in blower clears sawdust from guide line. Fitted with a quick-change blade chuck that holds blade securely when locked. Motor is controlled by a recessed switch. Weighs 6 lb.

Dalton Mfg. Co., 20 S. Central Ave., St. Louis (Clayton) 5, Mo.



4

5



TOOLS

6. BACK STAND is designed to support long stock behind circular saw, bandsaw or jointer. It is adjustable for height and sturdy column is fitted with a wide three-point support so that it stands firmly in any position on an uneven floor. Wide roller is of hardwood to prevent marring finished stock. Telescoping section of column locks at any point by means of a palm screw. For extra-long stock, use in pairs

Design Associates, 1924 Greendale Ave., Park Ridge, Ill.

7. HOLE CUTTER for installing electrical outlet boxes in dry walls eliminates plaster-patching openings after installation of boxes. Consists of a two-piece die, the outer half of which is snapped into the switch box before dry-wall sheet is nailed in place. Next, cut with a hole saw at approximate center of box. Two members of die are engaged through hole locking being automatic. Then close cutter handles

Hartmeister, Rm. 8, 2020 W. Barry Pl., Denver, Colo.

8. DOUBLE HACKSAW permits use of two blades on the same frame. This is especially useful when the work requires the use of blades of different tooth spacings. Handle is designed for a comfortable grip when using either blade. Tubular frame has a removable end cap so that tube can be utilized for storage of spare blades. A turnbuckle tensioning device maintains an equal tension on both blades while in use

Dreier Brothers, Inc., 5642 Lake Park Ave., Chicago 37

9. BENCH MILLING MACHINE is designed for milling operations on small precision parts at speeds up to 45,000 r.p.m. with carbide cutting tools. Universal head adjusts to any position through 360 deg. Work surface of table is 4 x 12 in. Table has standard 1/2-in. T-slot and is mounted on dovetail slides with an adjustable gib. Hand-lever feed is 5 in. and saddle travels 3 in. Micrometer-type feed screws are available

Precise Products Corp., 1328 Clark St., Racine, Wis.

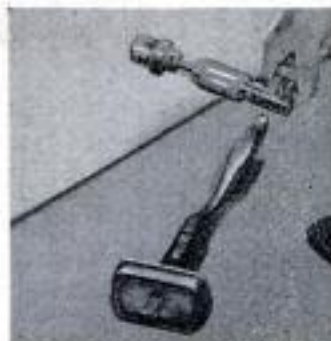

7

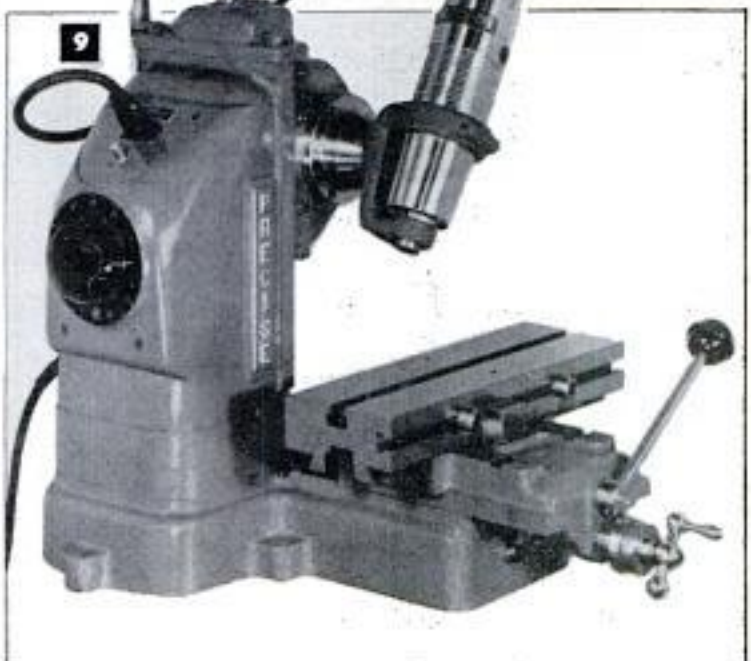



Fire Extinguisher on Farm Tractor Mounted Within Easy Reach

Taking no chances in the event of a fire while working in the field, one farmer mounted a small fire extinguisher within easy reach on his tractor. Clamped in a U-shaped bracket bolted to the steering post, the extinguisher is always close at hand during operations where the fire hazard is exceptionally high, as is the case, for instance, when using mounted corn pickers on dry, windy days.

A. M. Wettach, Mt. Pleasant, Iowa.

Tubing Cut in "Miter Block" Made From Hardwood Cube

SAW KERFS FOR HACKSAW

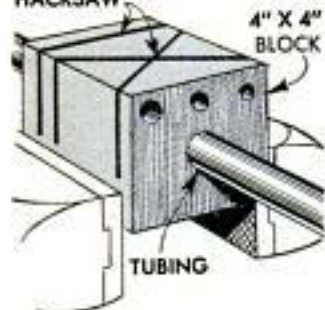

Having frequent need to cut tubing at a 45-deg. angle, one mechanic made a "miter block" from a 4-in. block of hardwood. Holes of a diameter to accept various sizes of tubing were drilled through the end

grain of the block, then 45-deg. and 90-deg. saw cuts were made in one face of the block to intersect the drilled holes. The miter block should be clamped in a vise when it is being used.

William B. Eagan, Louisville, Ky.

Chain Hooked to Out-of-Reach Eye With Aid of Hose Extension

Desiring to hook a hoist chain onto a ceiling eye without the use of a stool or a ladder, one mechanic slipped a length of radia-

tor hose over the chain just below the hook to serve as an extension handle. The hose proved sufficiently stiff to support the chain in an upright position, thus making it possible to reach the eye and hook the chain onto it with little difficulty.

Flaring Tool for Copper Tubing Improvised From Steel Rod

In an emergency when a regular flaring tool is not available, the ends of copper tubing can be flared by using a tool shaped from a nail or steel rod of the same diameter as the inside of the tubing. The rod is shaped to approximate the angle of the flare

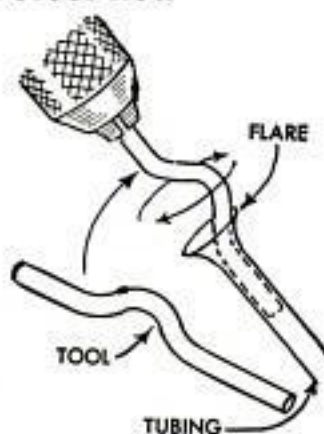

and chucked in a hand drill or brace. The tool is dipped in oil; then, while being turned, it is forced gradually into the tubing until the correct flare is obtained.

Tin Cans Fitted Over Jar Lids Provide Lathe-Chuck Storage

Ordinary tin cans, fitted over jar lids, may be used to provide dustproof containers for storing various kinds and sizes of lathe chucks. As shown in the illustration, the jar lids are screwed to a length of 1-in. stock, wide enough to hold the largest chuck. Tin cans, of a size to cover the various chucks, are fitted over the lids.

Hugh Botts, New York City.



Radio TELEVISION Electronics

COLOR-TV FIELD TESTS

ALTHOUGH most small-town and rural residents have seen very few color-television receivers or programs as yet, they may have watched in operation a truck which is responsible for some of the most advanced color-TV research going on in industry today.

Photos A, B and D show various views of the truck which contains the Motorola Mobile Television Laboratory that has been roaming the country testing and re-testing all aspects of color-TV engineering. This mobile laboratory is an invaluable tool for analyzing problems and new developments "on location." The complicated circuitry of color TV and the new problems it brings require such field testing. Simulating fringe or interference problems is a simple procedure with a mobile laboratory as it can move right into the trouble area for the desired check and correction of many difficulties never even suspected in plant laboratories. Photo A shows a receiver under test on location. Not only color, but all new developments in TV including antenna arrays can be tested. In photo B the engineers are raising a UHF array on the tower attached to the rear of the truck; this tower will extend to a height of 60 feet. Photo D shows an engineer testing UHF reception in a fringe area.

Partly as a result of the extensive testing, the manufacturer enters the color-TV market with one of the first large, 205-sq.-in. screen receivers, illustrated in photo C. An unusual feature of this model is placement of two 7-in. oval speakers above the picture tube, directing the sound to ear level.

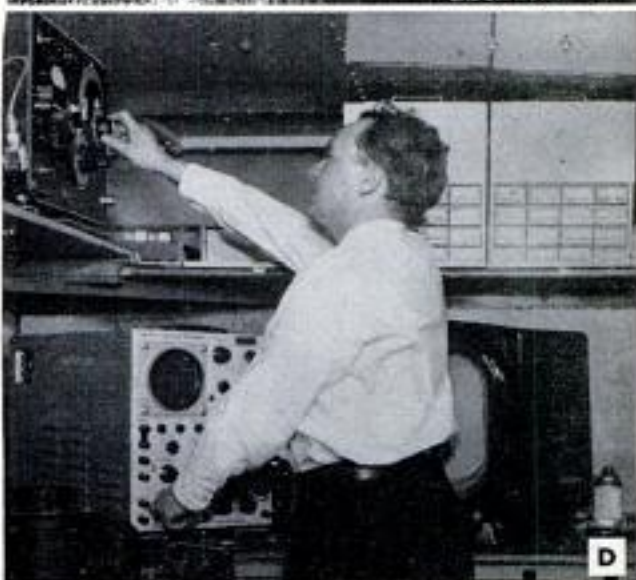
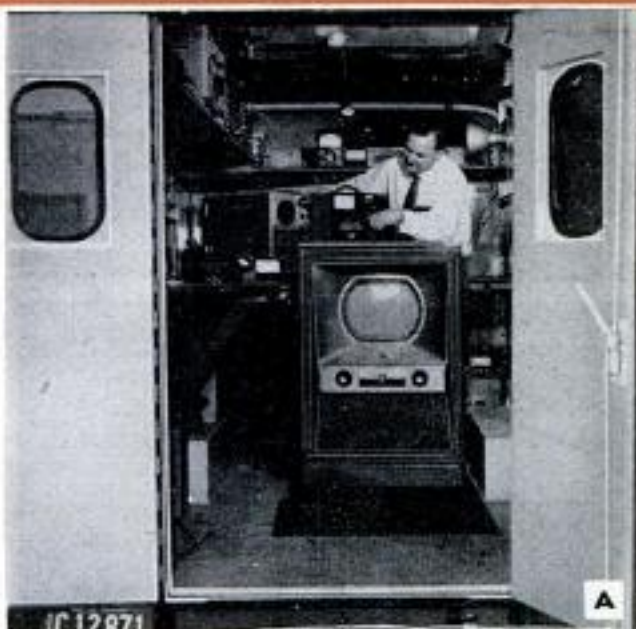

TWO LOW-COST HIGH-FIDELITY

By Dr. R. C. Hitchcock



A

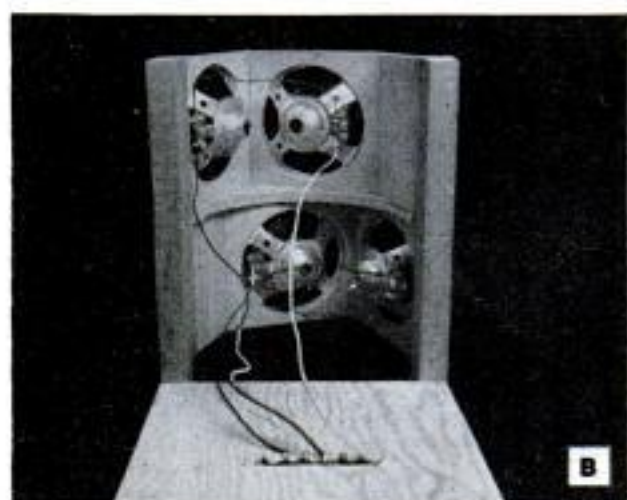

B



C

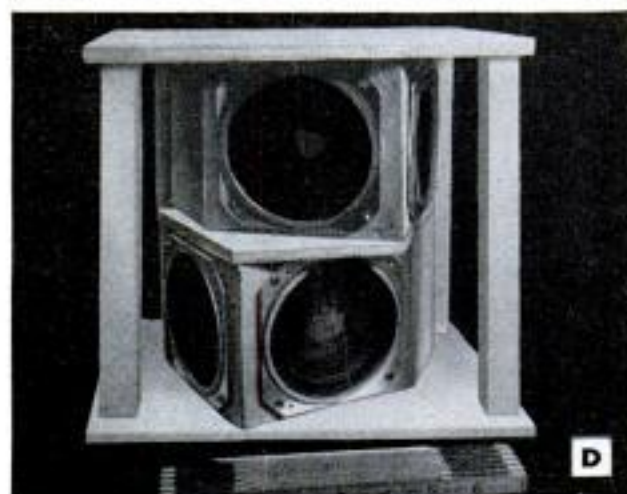

D

BASED ON *sound* principles, multiple-speaker systems are increasing in popularity. The reason for this is that several inexpensive permanent-magnet (PM) loudspeaker units can outperform a single expensive loudspeaker unit. Here are two up-to-date designs with superior performance and each uses four PM speakers.

Loudspeaker enclosures must not vibrate. These enclosures are sometimes made of heavy wood but, in the designs shown here, lightweight plywood, securely braced, is used as much as possible. In these designs the speakers are angled to spread the high tones in four adjacent overlapping beams of sound. No crossover networks are needed when all speakers are identical.

The infinite baffle unit illustrated in

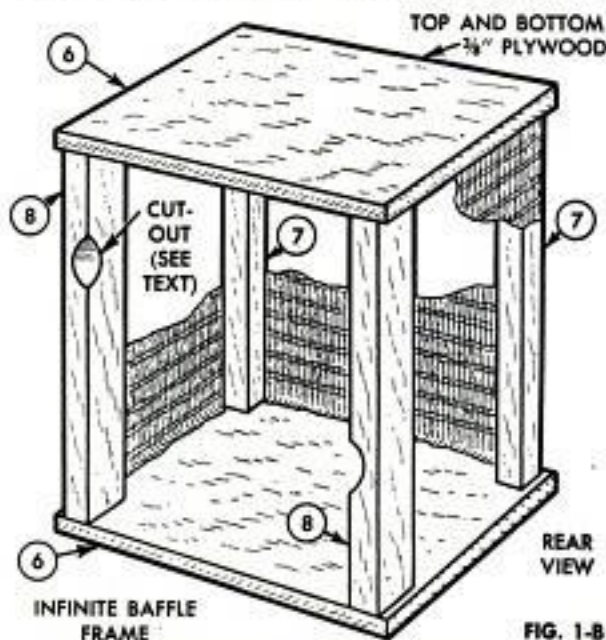
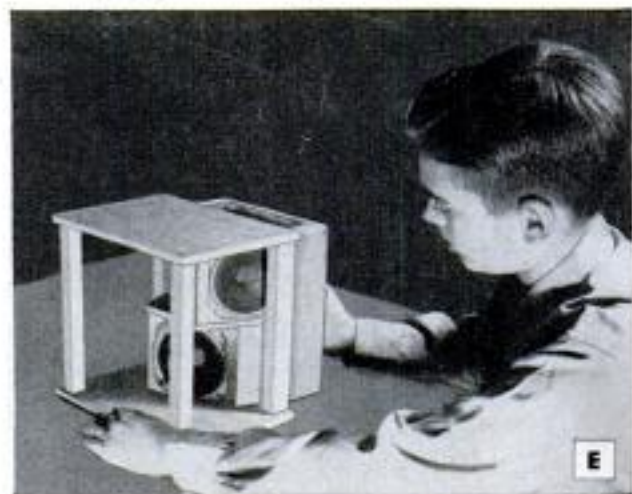

FIG. 1-B



E

MULTIPLE-SPEAKER ENCLOSURES

photos A, B, C, D and E is an ideal solution to the "second speaker" problem. Back-loading is not practical for a small unit so a completely enclosed box is provided. Construction details are shown in Figs. 1 and 1-B. A piece of glass fiber, $\frac{3}{4}$ x 13 x 9½ in., should be fastened to the inside of the back panel over the terminal strip, to absorb radiation from the speaker units. This unit has a maximum input of 3 watts, it employs four 4-in. PM speakers and weighs 4 pounds. It may be used as a main speaker for a table-model radio or as a remote speaker. A narrow cutout is made in the back panel (item 5) for the 6-terminal strip and the internal and external connections are made as shown in Fig. 1-A. Although the complete unit is small and light in weight, it will sound better than most radio speakers, even 8-in. ones. When used as the main speaker for a table radio, the connection should be 4 ohms. If used as a remote, or second speaker, it can be connected for 16 ohms, so as not to absorb too much energy from the main speaker. Use ordinary rubber-covered lamp cord for connecting cable to remote locations; do not use hookup wire or bell wire.

Multiple-speaker systems must have all speakers work in unison, that is, all cones must go out, and come in, at the same time. This is easily checked with a 1½-volt dry cell. Connect them all in series and com-

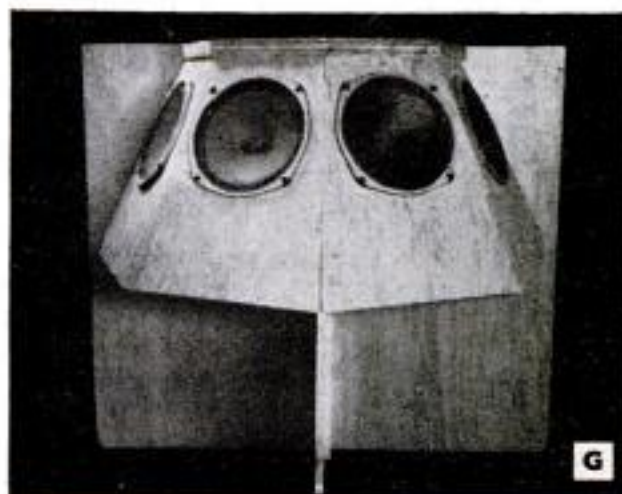
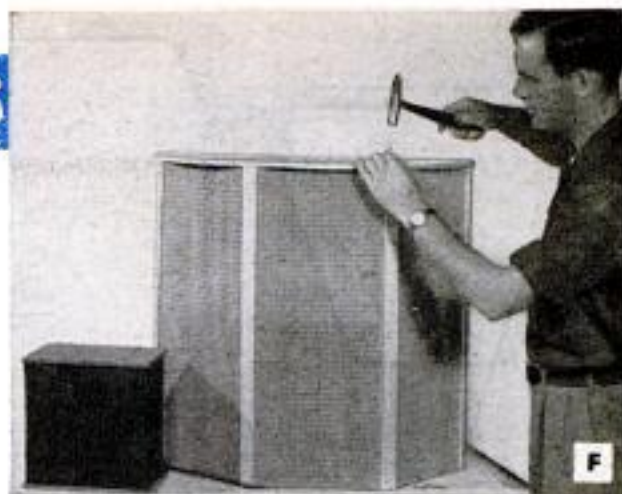
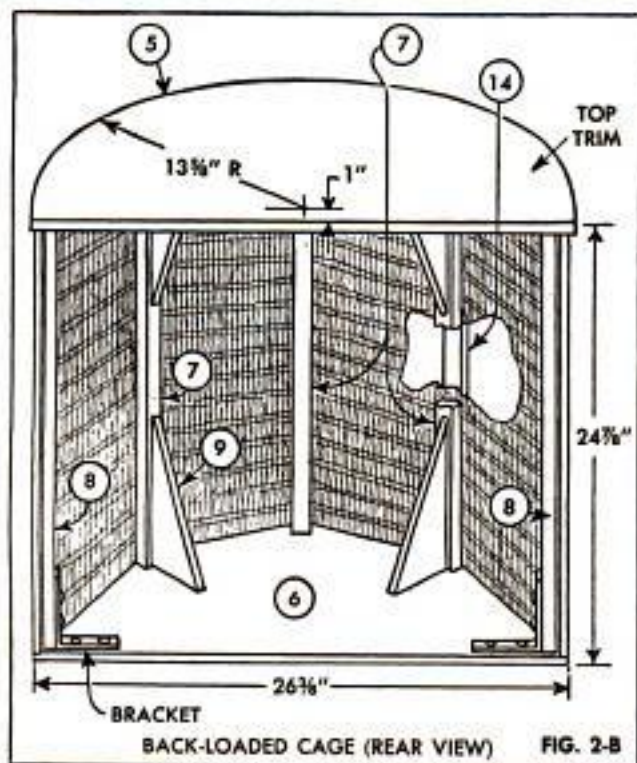

plete the circuit through the dry cell momentarily. If one of the speakers is not "in step" merely reverse its wires.

Use a good grade of glue, and headless brads for construction. Two notches in the back pillars of the infinite baffle are provided for insertion of a screwdriver to remove the tight-fitting speaker assembly from the baffle frame, see Fig. 1-B. Screws are used to fasten the back and also to hold the baffle unit to the frame; see sketch at upper left in Fig. 1.

The back-loaded system illustrated in photos F and G, and Figs. 2 and 2-B, has a maximum input of 15 watts; it employs four 6-in. PM speakers of the extended-range type and weighs 22 pounds. It is designed for use as a highly efficient speaker in high-fidelity phonograph systems where back-loading can be used to advantage. It may also be used in small auditoriums with PA systems. When a microphone is used the speakers must face away and be placed at least 10 ft. from the microphone. Complete construction details are illustrated in Figs. 2 and 2-B.

The d.p.d.t. switch and output-terminal connections are shown in Fig. 2-A. This switch, when thrown one way connects two speakers in series for 4 ohms; thrown

(Continued to page 352)

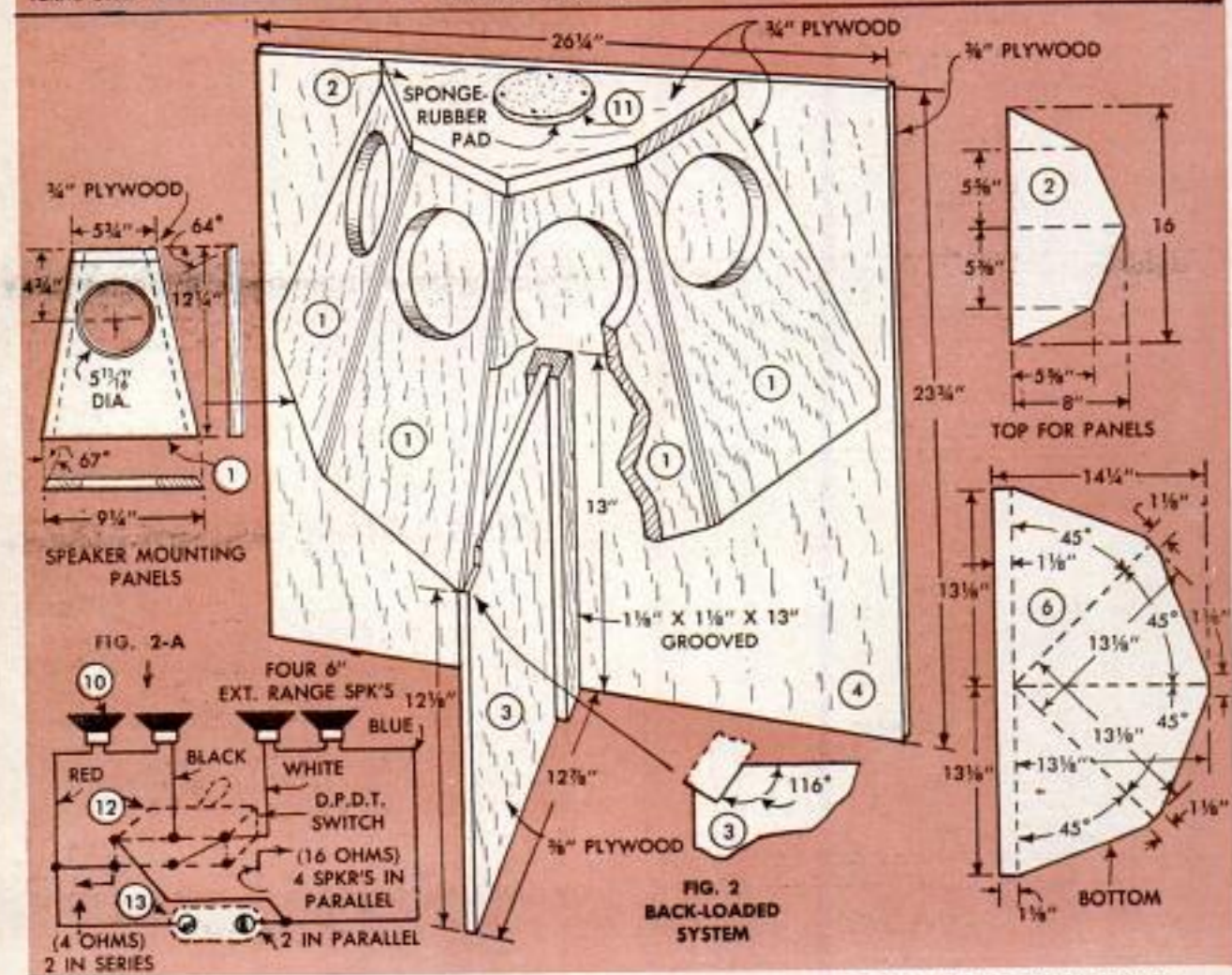
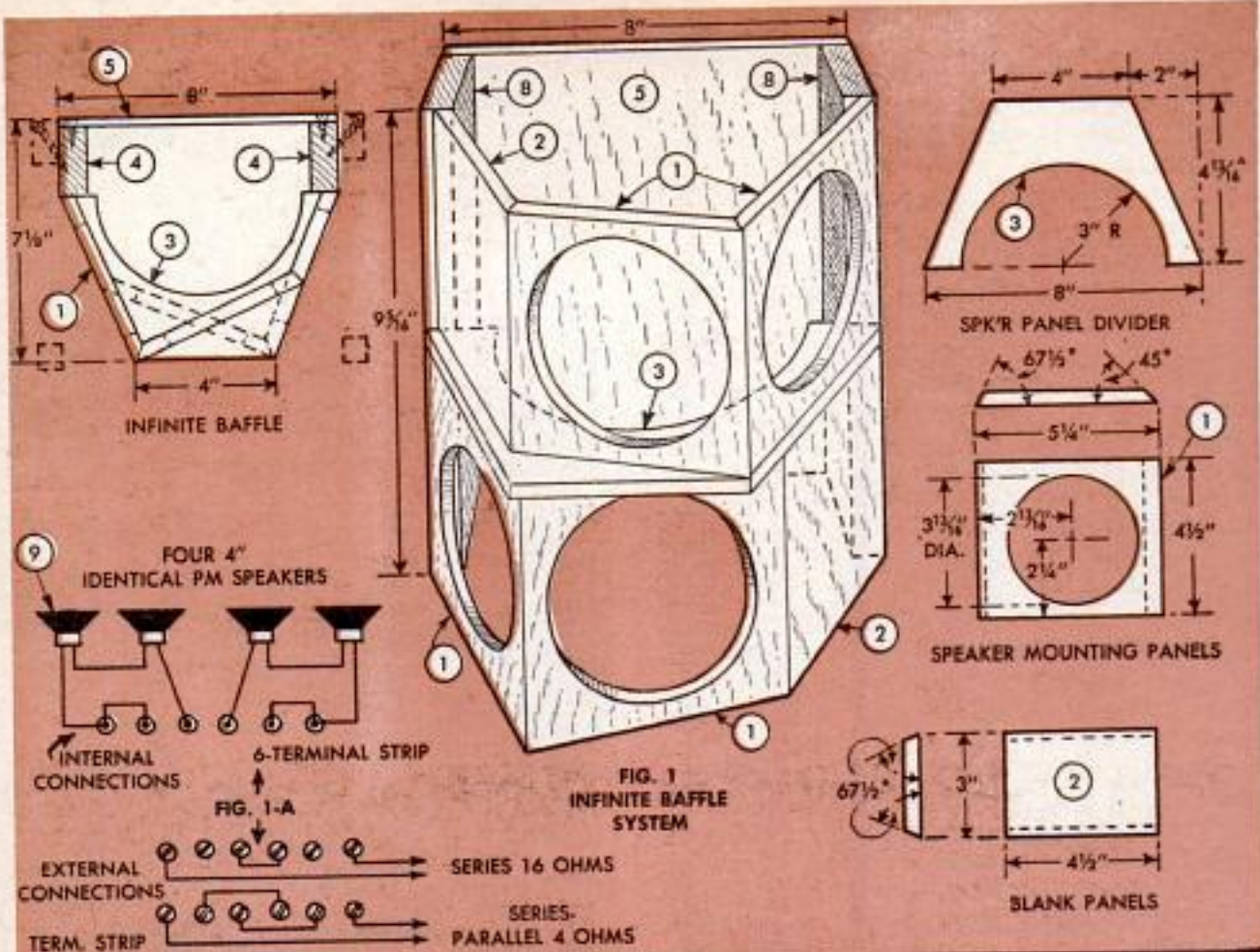



Fastest Fighter on Four Legs!

Hindus train the cheetah to hunt antelopes—but only because certain inborn qualities give it remarkable speed, power and fighting instinct.

In the same way, it is the inborn qualities of Macmillan Oil improved and enriched by an exclusive refining process that make it the finest performer among modern motor oils.

*It's the Nature of the Beast
... It's the Nature of the Oil!*

VALVE LIFTERS STICKING? Ping Trouble in Your Car?

BESIDES decreasing engine wear, Macmillan RING-FREE Xtra Heavy Duty Oil definitely reduces engine ping and prevents sticking of valves and hydraulic lifters.

Here is a motor oil that really whips the problems of today's higher compression engines—yet you still pay only the regular 45¢ per quart.

Macmillan backs these facts with an unconditional money-back guarantee.

Why is Macmillan able to make such a straightforward guarantee? The answer is that Macmillan selects its crude oil from one special area, where the oil has these *three great inborn qualities*:

1. Greater Natural Detergency
2. Higher Film Strength
3. Less Carbon Formation

All modern oils contain additives; and the Macmillan RING-FREE Xtra Heavy Duty Oil you buy already has special additives in just the right proportion to suit the qualities of the oil.

But it takes more than additives to make a great motor oil. For one thing, additives don't last. But Macmillan's great natural *inborn qualities* give better lubrication than other oils throughout the drain period.

* * *

Drain and refill with RING-FREE Xtra Heavy Duty. If it doesn't put a stop to sticking valves and excessive engine ping your dealer will return your money—in full. Macmillan Petroleum Corporation, 530 West Sixth Street, Los Angeles 14, California.

Why Pay a Premium?

LOOK FOR
THE BIG,
RED "M"

*...and pay only
45¢ per quart*



MACMILLAN RING-FREE XTRA HEAVY DUTY MOTOR OIL



Think of catching literally thousands of flash pictures like this on one battery!

You can—if you use low-cost B-C Flash

We don't have to tell you the beauty of taking pictures with flash. You carry your own sunlight around with you . . . put just the right amount of light right where you want it.

However—it's been found that, when the batteries in a flashholder become weak with age, they can be slow in firing the flash bulb. Consequently, you miss the picture. *That's where the new B-C (battery-condenser) Flash comes in.*

Here's how B-C works

A small 22.5-volt photoflash battery feeds power to a condenser which stores the power until needed. When you trip your shutter, the con-

denser, fully charged between shots, fires the lamp in a single surge *many times as strong* as the force of the usual 1.5-volt flashlight batteries.

Now you can see right away that the B-C method offers you some really important advantages. First of all, of course, is the fact that you get full voltage on every flash shot. Secondly, B-C assures positive and reliable timing even when the battery begins to weaken. Thirdly, the condenser charge is so powerful that it will fire several bulbs at once (instead of having to have an additional set of dry cells for each flashholder). And when the circuit is wired in series, all the bulbs fire at the same instant—no laggards. And to top it off, B-C is thrifty. It avoids failures and misfires that waste bulbs and film. Generally speaking, a single leak-proof battery is good for thousands of shots . . . does the job of several ordinary batteries.

On the opposite page there's a guide on how to choose just the right B-C Flash for your needs. Your photo dealer will be glad to help you select the equipment that's best for your camera.

Now here's how to choose the B-C Flash that's best for you

For simple flash photography, choose the KODAK B-C FLASHHOLDER

If you plan to use from one to three flash bulbs at a time, the sturdy, low-priced and popular Kodak B-C Flashholder will serve your needs very well indeed. It takes the inexpensive, readily available "midget" bulbs (SM, SF, No. 5 or 25). Its new Lumaclad reflector gives you 50% greater light output than matte-surfaced reflectors, has a handy exposure guide printed right on it. The quickly adjustable bracket fits most flash-shutter cameras, is easily removable for off-the-camera flash. Has transparent flashguard (for protection if a bulb should break) and "pop-out" type bulb ejector. A real value at \$9.95*. Flashholder also provides connections for one or two Extension Units for multiple lighting. Each unit, with 20-foot cord and cushioned, adjustable clamp, \$11.



If you're interested in advanced flash, you need the KODAK EKTALUX FLASHHOLDER

For advanced photoflash work you'll want the Kodak Ektalux Flashholder. B-C powered, it simultaneously fires up to 6 bulbs employing up to 120 feet of extension cable. Magnesium-constructed for durability and light weight, it fits most types of cameras. Features convenient, pistol-grip handle; removable, easy-to-pack reflector; quick load-eject sockets for both midget and medium-base bulbs. Addition of solenoid permits tripping shutter from Flashholder; a Synchro-Switch permits external synchronization if needed; Remote Release Cord permits exposure control up to 20 feet from camera. Brilliantly meets the most exacting tests of flash taking. From \$29.75*

Eastman Kodak Company
Rochester 4, N. Y.

If you already own a flashholder, the KODAK B-C FLASHPACK is for you

If your present flash equipment accepts two "C" type flashlight dry cells, end-to-end, you can convert it to dependable B-C flash at minimum cost. Just slip this low-cost Kodak B-C Flashpack and a 22½-volt photoflash battery into the dry-cell receptacle and you're ready to shoot! \$2.95*

*Batteries not included

*Prices subject to
change without
notice*

Kodak
TRADE-MARK

Care and Feeding of Engines



BY
S. P. CORP

EXCESSIVE USE OF OIL

Before you decide to correct oil consumption by installing Sealed Power KromeX Ring Sets consider these alternatives:

- 1. FAST DRIVING AFTER SLOW DRIVING.** If you have been driving slowly in town, condensation has probably diluted your oil. If you then go on a trip, with prolonged high speed driving, engine heat will evaporate the dilution, showing a lower oil level. This is normal and does not mean trouble.
- 2. CONTINUOUS HIGH SPEEDS** over 60 mph always cause engine to use more oil than lower speeds.
- 3. IMPROPER READING OF OIL STICK** will result if car is not level or stick is not pushed way down. Let engine be stopped a minute before checking oil, to let oil drain down into crankcase.
- 4. USING A LIGHTER OIL** than the specified grade for prevailing temperatures will increase oil use.

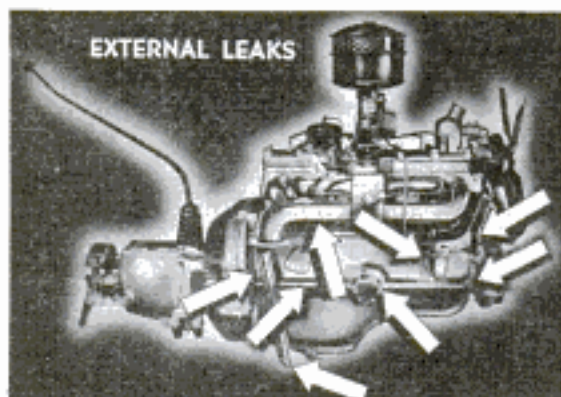

- 5. CHECK FOR OIL LEAKS** at the points indicated on the diagram. Replace any gaskets or oil seals which are found to be leaking.
- 6. VACUUM PUMP DIAPHRAGM** may be cracked which can cause oil burning. Replace diaphragm if damaged.
- 7. WORN VALVE GUIDES** may waste oil. Valve guide oil seals may correct this condition.

SEND FOR FREE MANUAL

BUT, if you have checked the above and still need an overhaul, be sure to re-ring with Sealed Power KromeX



Ring Sets—proved best for fighting heat, friction, corrosion and abrasion. Factory-seated for fast break-in and immediate oil control. A postal card will bring your free copy of the valuable manual, "MORE POWER, Less Gas, Less Oil." Address Sealed Power, Dept. G-10, Muskegon, Michigan.

Sealed Power

PISTON RINGS

Clinic for Homemakers



As a service to our readers in solving the hundreds of problems pertaining to a home—inside or out—the editors of *Popular Mechanics* invite you to present your problems to The Clinic Editor for help and advice. Address your questions to The Clinic Editor, *Popular Mechanics Magazine*, 200 East Ontario Street, Chicago 11, Ill.



Roof Decking

Q—I'm planning a new home with a studio living room in which the rafters will be exposed. My problem is what kind of roof boards and insulation to use on this type of roof. I'm told there are several methods. But what is applied over the rafters in order to obtain a smooth surface for finishing?—K.F., Colo.

A—There are, as you say, a number of methods of applying the roof decking over a studio room. One procedure that has become fairly common is the application of selected knotty-pine roof boards over the rafters. These are covered with aluminum foil and then the weather roof is applied over this. Such a combination of materials seems to prove quite satisfactory. However, regular procedures have been greatly simplified by the introduction of a new laminated roof decking, the underside of which provides a prefinished ceiling. It is suitable for use anywhere the roof decking is exposed in the room below, as in flat or pitched roofs of any type. The insulation is incorporated in the material itself, thus saving installation time for the builder. Also, the insulation is more efficient percentage-wise as the entire roof area is covered and not just the spaces between the rafters, as is the case in some installations.



Floor Over Slab

Q—I want to lay a hardwood floor over the concrete-slab floor. I have only lately decided to do this. The concrete floor was laid without any provision for attachment of furring strips. I would rather have oak flooring boards than any type of wooden flooring squares. Is it practical to attempt this job?—P.W., W. Va.

A—Yes, but it will require the expenditure of considerable time and labor if you want a top-notch job. We hesitate to recommend that you undertake it because of the labor and materials involved and also the fact that everything in the house must be moved out in order to carry out the procedure in detail. However, if you wish to go through with the process, the first step is to clean the floor thoroughly and make sure that it is dry. Effective protection against moisture from below,

(Continued to page 254)

FOR YOUR FAMILY...FOR YOURSELF

Can you budget each week ...\$2...\$4...\$6...?

FREE new booklet shows you
how to guarantee an income for
your family...and how to
plan for your retirement



Now at even LOWER
COST our NEW John
Hancock program can
meet your needs bet-
ter than ever.

If you were to die—if your pay envelope stopped—your family would be faced with the immediate problem of replacing your pay check—at least in part.

Perhaps your wife could eventually get a job. But do you want her to *have* to do this? It's pretty hard for a widow with young children to work at a job *and* at the same time give your children the proper care you'd want them to have.

Today there is a practical way you can meet this problem. If you make up your mind to budget just a few dollars a week, you can provide guaranteed protection for your family.

Write for our free new booklet called "Face the Facts." It will show you:

1. How to figure out the amount of money your family would need in case something happened to you.
 2. How much money you would have to budget for a plan that will give your family protection.
 3. How this plan also helps you provide future dollars for yourself.
- We'll mail you a copy of this booklet absolutely free and without obligation. Use coupon or a postcard.

John Hancock
MUTUAL LIFE INSURANCE COMPANY
BOSTON, MASSACHUSETTS

THE JOHN HANCOCK
200 Berkeley Street, Dept. K-1
Boston 17, Massachusetts

Please mail me a free copy of the new
booklet "Face the Facts."

Name _____

Address _____

City _____ State _____



DO-IT-YOURSELF and
Save Over 50%
 on Extruded Aluminum
COMBINATION WINDOWS
 and **DOORS**



Compare this quality, extruded aluminum Combination Window at just \$9.95, with any \$25.00 window. You make equal savings (over 50%) on all U-Fab-It-Urself "Home Comfortizing" Products—equal to the finest on the market—due to mass production and elimination of assembly costs, because you "do it yourself." Combination Screen - Storm Windows and Doors go up once and stay—forever.

KITS INCLUDE: All parts factory cut, drilled, mitered and hardware attached. The following Complete Line of U-Fab-It-Urself Kits engineered for easy assembly with household tools:

- COMBINATION WINDOWS
- PICTURE WINDOWS
- COMBINATION DOORS
- BASEMENT WINDOWS
- SCREEN DOORS—SCREENS
- CASEMENT WINDOWS

"Satisfaction Guaranteed"

Send for
FREE BOOK
 on Complete Line
 of Deluxe
 Combination
 Windows
 and Doors.

U-FAB-IT-URSELF, INC.
 Worthington, Ohio

Rush me your FREE Complete Line BOOK of Deluxe Combination Windows and Doors, PM1054.

Name

Address

City..... State.....

(Continued from page 252)

also against insects, is obtained by mopping on an asphalt-coated felt membrane with hot tar. Where possible, the membrane should be carried up the walls from 2 to 4 in., or to a point where it will be covered by the baseboard. Be careful not to get tar on the walls above the extension of the membrane. Instead of laying furring strips, it's a common practice to lay what are known as screeds to provide a nailing surface. These are short lengths of 2 x 4s, usually about 30 in. long, laid flat side down and embedded in asphaltic mastic with the ends lapping in the manner shown in the sketch. It's the usual practice to space the screeds on 12-in. centers. Spaced on 12-in. centers with the ends lapped past about 6 in. the screeds provide a solid nailing surface for the flooring. This offsets any tendency to springiness and prevents the development of squeaks. It's a good idea to dip or coat the screeds in a wood preservative before laying.



Locating Thermostat

Q—I'm installing my own forced-air heating system. I have five rooms with a large, square living room. Furnace is in the basement and directly under the center of the house. Where should I place the thermostat?

T.K., Ky.

A—You pose a question difficult to answer with certainty without knowing more about the relation of the various rooms, exposure to prevailing winter winds, location of the warm-air registers and placement of the cold-air returns. All these are determining factors, to a greater or lesser extent. Ordinarily, the thermostat should be located in the most lived-in room of the house, usually the living room in a small home. Most thermostats are extremely sensitive to changes in temperature; even the small hole in the plaster through which the wires are led to the terminals may admit sufficient cold or warm air to affect the operation of the unit. Avoid placing a thermostat where there may be currents of warm or cold air or on an outside wall which may become very cold during a period of severe winter weather. Be sure that the 'stat is not placed on a wall near a warm-air riser leading to an upstairs room, or opposite the kitchen range, or where a current of warm air from a register can strike it directly before being dissipated throughout the room. The thermostat should not be placed at any point on a wall where direct sunlight will strike it at any time during the day.

Bubbles in Varnish

Q—Recently I varnished an antique on which I had spent considerable time and effort in removal of the old finish and sanding of the wood. Although the varnish dried satisfactorily, the surface was very rough due to innumerable bubbles which appeared as it was spread. It seems impossible to sand or rub them out. Can you tell me the cause?

O.B., Vt.

A—Did you shake the container before applying the varnish? If you did, then there's one of the most common causes of trouble with bubbles in either varnish or shellac. This is especially true if the material has aged somewhat or has thickened slightly due to exposure to the air. It is permissible to stir varnish or shellac before applying, but this should be done very lightly and the container should be allowed to stand for a few minutes before the materials are applied. Of course, there are other causes, some more difficult to determine. Sometimes the brush used is at fault, or the manner of application. The brush may be contaminated with other materials which react with the oils in the varnish or the alcohol in shellac to produce the objectionable bubbles in the surface film after application. In some cases, quick, hard strokes of the brush will result in bubbles unevenly distributed over the surface of the work. In your case we would suggest that you remove the present finish back to the bare wood and begin over again with fresh finishing materials. We think it likely this will prove the surest remedy.

first,
compare
PRICE TAGS
... then ...

COMPARE



GIVE YOU FAR MORE
PER BUILDING DOLLAR because of

V TREMENDOUS LABOR SAVINGS



THE ALDRIDGE—1100 sq. ft. including garage—2 bedrooms—features economical floor plan, large rooms, low modern exterior. Designed for construction on a slab.



\$3,700⁰⁰

All prices shown are freight paid within 11 Midwestern States—slightly higher in other areas.

"Best Sellers" BY PAGEMASTER

Probably the biggest, most important purchase you'll ever make is your home. Don't buy the price tag until you *compare values!*

Pagemaster offers you many, many advantages and far more for your building dollar. Take advantage of our 50 years of building know-how, professional planning and modern engineering techniques that go into *every* Pagemaster home.

Only top quality materials and the best nationally advertised equipment are used. That is why Pagemaster homes set the quality standards for the entire home industry.

Our large quantity purchases result in great material savings. These savings are passed on to you. Besides, all materials are measured, cut and sub-assembled right at the factory, eliminating the possibility of costly, on-the-job errors. Whether you do it yourself or hire someone to help you, you'll build in less time, use less labor, with less waste and for *far less money.*

Build today the Pagemaster way and *save, save, save!* Enjoy the styling, the comforts, the quality that only Pagemaster can give you, and at a price you'll be glad to pay. Write for names and addresses of satisfied Pagemaster home owners everywhere. There may be one or more in your neighborhood. Buy Pagemaster and put the additional dollars in the bank!

PAGEMASTER HOMES come to you in one package ready to erect. Any plan can be modified to meet individual requirements. And this is important too—Pagemaster Homes are built to meet FHA and VA financing requirements.

WHETHER OR NOT YOU ARE PLANNING TO BUILD THIS YEAR, YOU'LL WANT THIS CATALOG! SEND 25c TODAY FOR THIS BEAUTIFUL, FULL-COLOR HOME BOOK.

300 PIERCE ST.
SHAKOPEE, MINNESOTA



\$3,400⁰⁰

THE FREMONT—24'x32'—2-bedroom beauty—lots of living at minimum cost.



\$3,400⁰⁰

THE DEAN—1194 sq. ft.—including garage, 3 bedrooms, compact kitchen, large closets.



\$3,400⁰⁰

THE KAYE—1146 sq. ft.—4 large bedrooms, U-shaped kitchen, sheltered entrance, hip roof—Deluxe throughout.

CLIP AND MAIL

**PAGEMASTER HOMES
SHAKOPEE, MINNESOTA**

Gentlemen: Send your full-color catalog of beautiful Pagemaster Homes. 25c in coin is enclosed.

NAME _____

ADDRESS _____

CITY _____ STATE _____

Looking for Something?



**FROM LAWN MOWERS
TO LUMBER
WHATEVER YOU NEED**

**LOOK IN THE
'YELLOW PAGES'**
OF YOUR TELEPHONE DIRECTORY

The House You Asked For

(Continued from page 150)

In regard to kitchen arrangement, 68.4 percent asked for a breakfast area. The dining-room situation was not so simple and presented Architect Matern with a problem. There was a 34.9, 34.8 and 31.3 vote on (1) combination living-dining room, (2) combination dining-kitchen and (3) separate dining room, respectively. Matern's solution was a provision for dining-room space that can be separated by a screen from the living room. Further privacy from the porch side could be provided by draperies to cover sliding glass doors.

In planning the house, Matern did not ignore minority preferences. "I tried to work in features that would make everybody happy," he explains. "For example, the 27.6 percent who wanted only two bedrooms could use the third bedroom as a den or television room. And the 7.6 percent who wanted a split-level house might be content with having the two rear bedrooms and bath three steps up from the main floor of the house. The flat-roof fans (13.2 percent) should like the treatment of the garage and porch. There were 28.1 percent who wanted frame. The garage and one small section around the rear entrance are frame. Although we are showing the house in brick, it could, of course, be built with wood siding."

Some 58.8 percent voted for the open-plan arrangement of rooms. Matern achieved a fine open sweep of space in the living-dining-foyer and porch areas. When the glass sliding doors to the porch are open there is a full sweep from the living-room fireplace to the wall of the garage on the far side of the porch. Matern points out that those desiring more open planning than shown in the plans could easily lower the walls of the den-bedroom or use sliding or folding partitions between this room and the hall and living room. He reserved a special treat and another outstanding feature of the house for those who wanted the dining-kitchen arrangement. The eating space in the kitchen far exceeds average requirements for breakfast. This area with skylight and windows facing the garden patio is one of the most interesting parts of the house.

Exactly 52 percent specified 1½ baths. Many readers asked that the half-bath be close to the kitchen. Matern placed it not only close to the kitchen but also the den-bedroom. The baths are back-to-back for the economical use of a single plumbing stack. A typical comment on this subject came from a Plymouth, Wis., reader: "I

(Continued to page 260)

UP GOES
HORSEPOWER



WITH
LIVELY NEW

If you've seen a horse travel by balloon before, don't bother to read any farther. You know what we're going to say! Actually, putting Sparky in a balloon is just our way of telling you that with new AC Spark Plugs in your car, "Up goes horsepower!" AC engineers have designed special features into a spark plug to handle today's lively engines and lively gasolines. And the results speak for themselves. *Up to 10% more power! Gas savings of as much as one gallon in ten!*

If your car has traveled 10,000 miles or more since your last plug change, go to your nearest Registered AC Dealer. Get a new set of lively ACs.

ENGINEERED
TO THE TEMPO
OF TODAY!

PATENTED
INSULATOR
MATERIAL

PATENTED
HEAT-SEALED
CONSTRUCTION

PATENTED
COPPER-
GLASS SEAL

Boosts Power...
Saves Gas!

The Exclusive AC
Petticoat Insulator Tip
This recessed thin tip skirts,
but does not touch, the center
wire. It heats up more quickly,
burns away oil and carbon de-
posits which are likely to foul
ordinary plugs.

AC

SPARK
PLUGS



AC SPARK PLUG DIVISION
GENERAL MOTORS CORPORATION

STANDARD FACTORY EQUIPMENT ON CHEVROLET • PONTIAC • OLDSMOBILE • BUICK • CADILLAC • GMC

SHOTGUN BLASTS? NO..

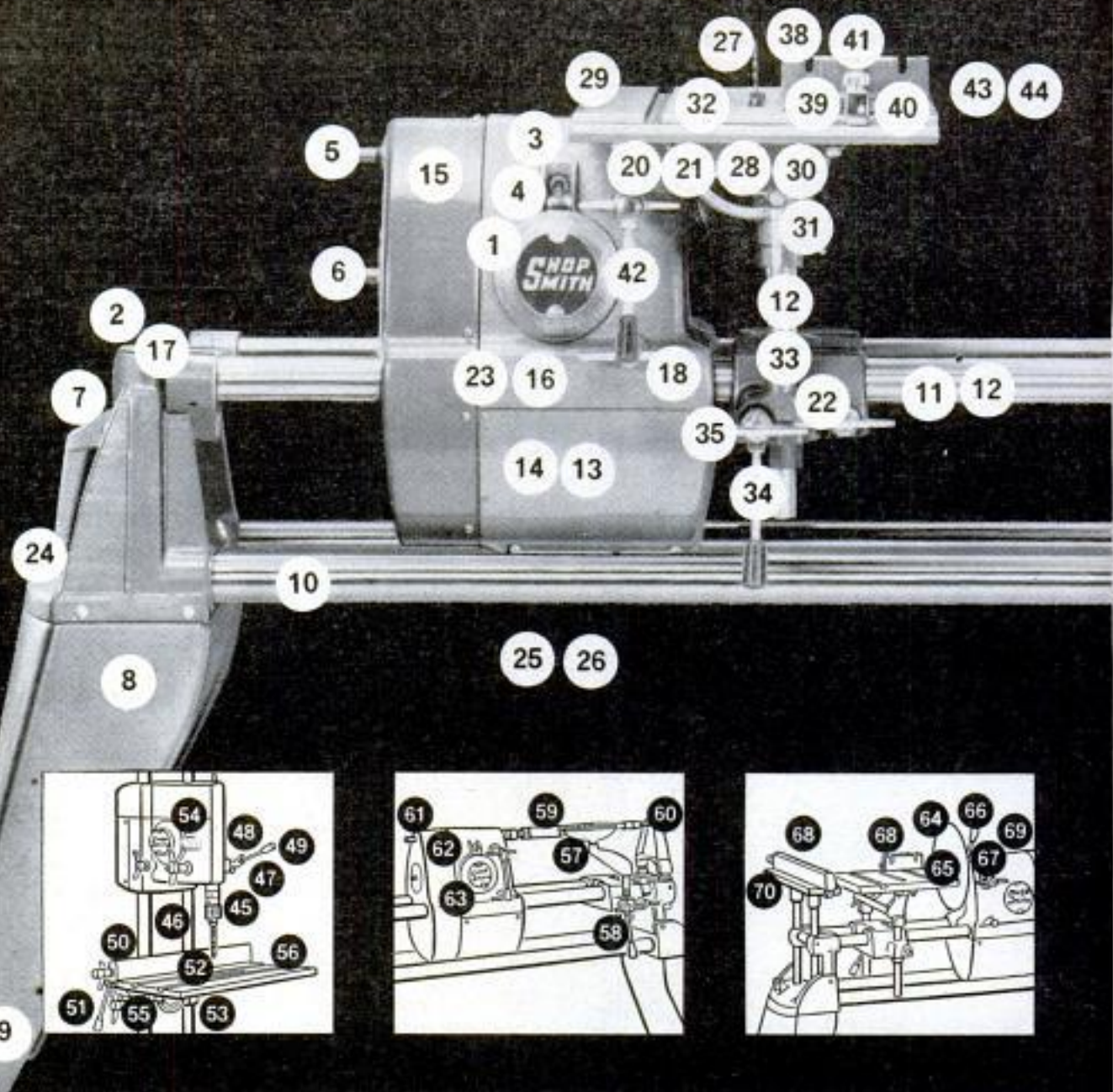

New SHOPSMITH as a Circular Saw

27. 9" All-purpose Saw Blade. 28. Quick-change Arbor— $1\frac{1}{4}$ " shank, centers blade over spindle. 29. 14" x 18 $\frac{3}{8}$ " Table—with precision surface, integral fence bar. 30. Calibrated Trunnion—guides table through tilt range, calibrated to 1° readings. 31. Auto-stops—adjustable Nylok set screws provide auto-stops at 0° and 45°. 32. Table Insert—coined and "bowed" for flush fit, two projections protect saw blade from hitting sides of insert. 33. Table Tubes—milled rack, chrome plated. 34. Table-height Lever—for extra-fast, hair-line adjustments. 35. Table-height Lock. 36. Self-squaring Rip Fence—one-knob control squares fence, locks it both on front and back of tables. 37. Depth-of-cut Scales—engraved on rip fence to provide positive accuracy regardless of variations in saw blade diameters. 38. Depth of Cut—up to 2 $\frac{1}{2}$ "; on 45° bevel, up to 2 $\frac{3}{8}$ ". 39. Calibrated Miter Gauge—calibrated to 1° readings. Glides on nylon inserts. 40. Miter Gauge Stops—at 45°, 90° and 45°. 41. Miter Gauge Lock—lets you lock miter gauge bar in table slots for accurate jiggling, rigid support. 42. Quill Micro-Feed—allows quick, precise blade-to-fence adjustments. 43. Blade-to-fence

Capacity—up to 48". 44. Effective Table Area—18 $\frac{3}{8}$ " x 56" with standard extension.

New SHOPSMITH as a Vertical Drill Press

45. Geared Jacobs Key Chuck—takes drills up to $\frac{1}{2}$ " shanks. 46. Large Capacity—drills to center of 1 $\frac{1}{2}$ " circle. 47. 4 $\frac{1}{4}$ " Quill Feed. 48. Depth Control Dial—no stop nuts, you just set the dial and lock it. 49. Right or Left Hand Feed Lever—lever detaches with a twist. 50. Ready-made Jigs—with miter gauge and rip fence. 51. Forward-feed Table—using table-raising lever, for light milling and fine adjustments. 52. Chuck-to-table Capacity—26" maximum. 53. Chuck-to-floor Capacity—58" maximum. 54. Speed-Dial—gives you proper speed for all drilling, mortising, routing and shaping operations. 55. Carriage Locking Knob. 56. Large Tilting Table—with rip fence to form V-block jig.

New SHOPSMITH as a Lathe

57. Universal Tool Rest—slides parallel to work, swings in full 360° arc. 58. Tool Rest Height Control—accurately adjusted through rack-and-pinion control. 59. Large Capacity

JUST THE NEW

FEATURES OF SHOPSMITH* Mark 5

It has the same famous SHOPS MITH® principle of 1 motor, 1 spindle, 1 table and 1 bench, but beyond that you'll barely recognize the all-new SHOPS MITH Mark 5. In fact, you can hardly touch the new SHOPS MITH without putting your finger on an exciting new feature! In many cases they're downright revolutionary developments... like the Speed-Dial or the Power-Mount. But to do justice to the NEW SHOPS MITH... and to your own hidden talents... you've actually got to see it *in action!* On display at leading hardware and department stores or any Montgomery Ward store. Five tool unit delivered complete, ready to plug in, for **\$269.50**

1. Speed-Dial—lets you select the correct speed for any job simply by turning a dial. Range: 700 to 5200 rpm. **2. Power-Mount**—for 10-second addition of auxiliary tools such as jig-saw or jointer. **3. Guarded ON-OFF Switch**—can't be knocked ON accidentally. **4. Speed-Dial Safety Catch**—automatically stops Speed-Dial at 3500 rpm... is spring-released for speeds above 3500 rpm. **5. Auxiliary Spindle No. 1**—lets you operate combination setups: jigsaw-sander, lathe-honing wheel, etc. **6. Auxiliary Spindle No. 2**—higher speed (1.7 to 1 ratio) for simultaneous saw-jointer operation. **7. Headrest Lock**. **8. Bench Ends**—made of rugged steel and included in price. **9. Pre-drilled Holes**—for mounting retractable casters. **10. Bench Tubes**—integral, rigid, corrosion-treated. **11. Tubular Ways**—centerless ground, heavy-duty twin tubes providing extreme rigidity, accuracy. **12. Rust-proofing**—tubes and columns are hard-chrome plated. **13. ¾-hp. Motor**—built-in, heavy-duty, ball-bearing capacitor-type. **14. Built-in Blower**—keeps motor temperature down. **15. Enclosed Belts and Pulleys**—an important safety feature. **16. Precision Cast Headstock**—made of aircraft quality aluminum alloy. **17. Hand Grip Locks**—one at each end for locking extension table, tailstock, accessories. **18. Headstock Lock**. **19. Extension Table**—fully adjustable to match height of saw table, mounts on either end of unit. **20. Ball-bearing Spindle**—lubricated for life. Spindle runout is less than .001". **21. Spindle Tip**—it's induction-hardened, has exclusive tapered safety flat. **22. Carriage Lock**—double wedge action locks and unlocks on both tubes. **23. Baked-enamel Finish**—two-tone, hammered effect. **24. Built-in Holder**—for chuck key and the one Allen wrench that controls all adjustments. **25. Overall Dimensions**—41½" high, 71" long, 19" wide. **26. Fully Assembled**—SHOPS MITH comes to you all ready to plug in.

—16½" swing, 34" between centers. **60. Eccentric Cup Center Mount**—easily offset up to ½" for turning 1" tapers over length of workpiece. **61. Extra Spindle**—for mounting honing wheel to sharpen chisels between cuts. **62. Movable Headstock**—slides to end of ways for easier faceplate turning. **63. Variable Speed Selection.**

New SHOPS MITH as a Sander

64. 12" Sanding Disc—statically and dynamically balanced. **65. Undercut Table Edge**—for 45° angle sanding without chatter. **66. Quill Feed**—allows sanding disc to be fed into work. **67. Quill Feed Stop**—for accurate duplicate sanding. **68. Miter Gauge and Rip Fence**—provide handy jigs. **69. Extra Spindle**—for mounting drum sander or another sanding disc. **70. Fence Offset Screw**—quickly offsets fence for accurate edge sanding and jointing of plywood.

New SHOPS MITH as a Horizontal Drill

71. Unlimited Work Length Capacity. **72. Miter Gauge and Rip Fence**—serve as accurate jigs. **73. Hairline Table Adjustment.** **74. 4¼" Quill Feed**—with depth control dial. **75. Variable Speeds**—from 700 to 5200 rpm. using Speed-Dial.

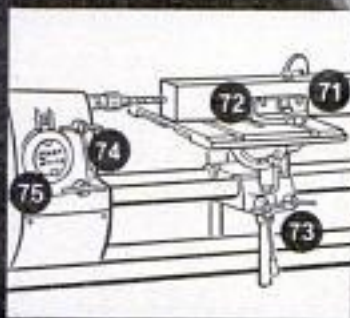

MAGNA ENGINEERING CORPORATION
Dept. 270-B, at factory nearest you
12819 Coit Rd., Cleveland 8, Ohio, OR
Menlo Park, California

I'm interested! Rush me your free 20-page catalog on the NEW SHOPS MITH. Also the name of my nearest dealer.

Name _____

Address _____

City _____ State _____

*Trademark Reg. U. S. Pat. Off. and in foreign countries.

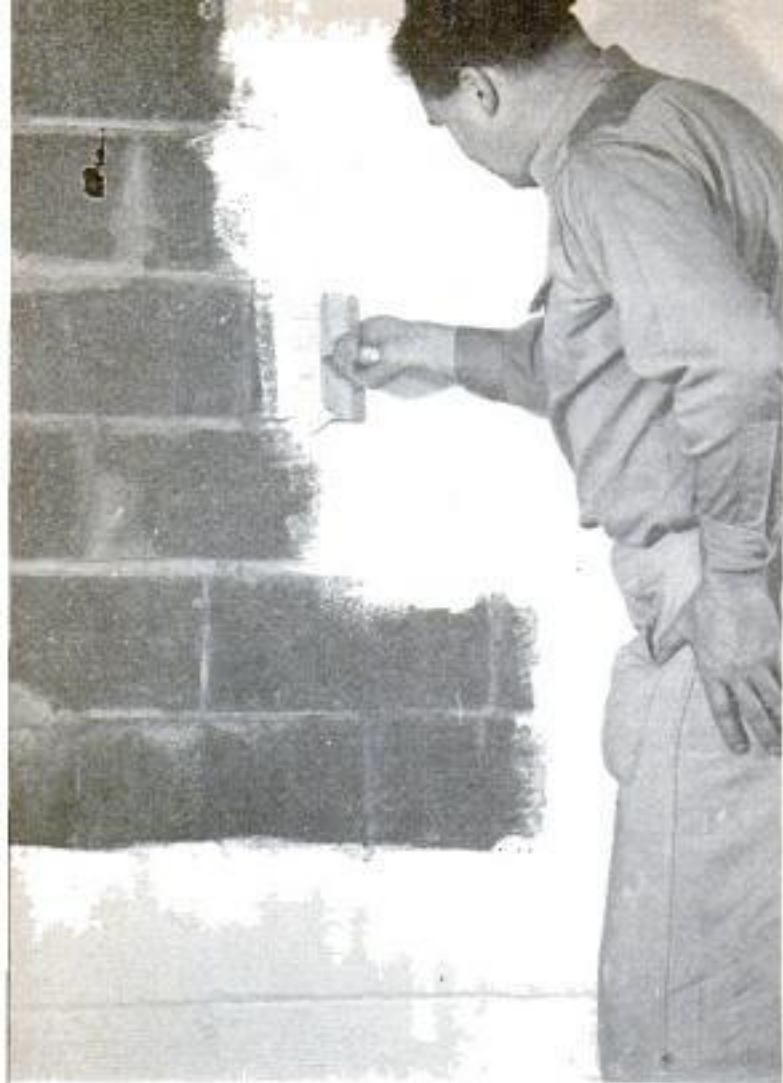

wet basement?

DURA-DRI it!

C E M E N T C O A T I N G

Now it's easy to dry up and brighten up a damp, dark basement with new DURA-DRI. You just apply this heavy bodied protective coating with a brush, right over any porous masonry. It actually becomes a part of the surface—controls water penetration . . . decorates in any one of four beautiful pastel colors.



DURA-STOP

COMPOUND—fills holes and cracks through which water flows

Use this new hydraulic cement when necessary, prior to the application of DURA-DRI. It sets in just three to five minutes; actually stops the flow of water.

For further information on these two TEXOLITE® paint products, see your TEXOLITE paint dealer, or write Dept. PM-10, 300 West Adams St., Chicago 6, Illinois. *T M. Reg. U. S. Pat. Off.



UNITED STATES GYPSUM

The Greatest Name in Building

would have a minimum of hall space with the bath close to the kitchen and arranged so you wouldn't go through the living room from the kitchen to go to the bath or the bedrooms." The architect's excellent solution for the handling of traffic to and from various rooms is quickly recognized by a glance at the plans.

A total of 33.2 percent requested a utility room (with space for washer and drier) adjoining the kitchen. Although the laundry is shown in the basement on these pages (in accordance with the majority preference) there is actually space in the kitchen for both washer and drier.

Bowing to the dictates of the 74.2 percent who asked for an outdoor living area, Matern has presented both garden patio and screened porch. During the warm months the porch functions as an extension of the living-dining area. The porch can be screened or not—depending on whether you live in the "mosquito belt."

Due to a vote of 48 percent, the house is shown on these pages with a brick-veneer exterior finish. If some kind of wood or shingle siding is used, Architect Matern urges uniformity of material across the front of the house. The structure would look much smaller, he points out, if the porch wall at the front were of different material.

A careful study of the house will show the tremendous possibilities for variations of the plan. It could be built with a carport or carporch in place of the screened porch and garage. These could be added later if the budget-conscious builder desires. Also, the house could be built without a basement. In this case the laundry would be moved to the kitchen and the garage workshop enlarged. The plans give the choice of a two-car garage or a one-car with additional storage space.

The price section of the questionnaire was presented with this admonition: "The home price you select should not be more than 2½ times your annual income, unless you have savings in addition to the minimum down payment. Your other selections should also take price into consideration. For example, a \$7000 home with three bedrooms would be very small and, unless you built it yourself, such items as a fireplace, air conditioning and two bathrooms would be out of range." The result was that 57.4 of the readers fixed the price they could pay, not including the lot, at between \$10,000 and \$15,000.

In designing the house with a floor area of 1275 square feet, Matern gave careful consideration to the survey. He was also influenced by the fact that 16.5 percent said

(Continued to page 274)

CRAFTSMAN

DIME/THIN

Cabinet Blades

save stock . . . saw more smoothly



Carpenters! Contractors! Home Craftsmen! Hobbyists! Now, at last, extra-thin cabinet making blades designed to give finest possible cuts from your power saw when used in hard or soft woods. Professional quality blades at regular prices with bodies actually thinner than an ordinary dime resulting in less material waste.

Just what every power saw user has been waiting for—a thinner cabinet blade for cutting Celotex, wallboard, fine grain dry materials, hard and soft woods, plywood, and even plastics with less splintering, more accuracy. Cuts made are so smooth that no further planing or sanding is necessary. See these blades today at Sears.

Fine Tooth Crosscut

CRAFTSMAN. An extra-thin crosscut saw blade designed to give smoothest possible cuts on trim work where fine work is desired. Gives extra smooth cuts for glue and miter joints with no further jointing required. Ideal for carpenters, contractors, and home handymen. Has 6½-in. diameter for CRAFTSMAN 6½ or 8-in. Electric Hand Saws and bench saws using blades with ½-in. round arbor holes. At Sears low, low price of only \$1.69, re-sharpening becomes impractical. Buy yours today.

Cabinet Combination

CRAFTSMAN. Now, a blade for use in cabinet making, model making, and pattern making, where fine work is absolutely essential. Amazingly thin (.030-in.), this blade is especially designed for extremely smooth finish rip, crosscut and miter cuts in hard or soft woods. Joints are cut with a minimum of waste—require no further jointing. Blade is 7 in. in diameter with either ½ or ⅝-in. round arbor hole for use on all 7 to 10-in. bench saws. Buy several of these blades at Sears low price of \$1.89.

Ply-tooth Blade

CRAFTSMAN. Cuts plywood with an absolute minimum of splintering. Also perfect for fine cabinet work, picture framing, pattern making, etc. Will cut thin plastic without chipping. Ideal for fine line sawing. Choice of 2 sizes: 4-in. diameter blade with ½-in. round arbor hole for use with CRAFTSMAN 6½ or 8 in. Electric Hand Saws, ½-in. electric drill attachments, and some bench saws; or the 7-in. diameter blade that fits 7, 8 or 10-in. bench saws and has either a ½-in. or ⅝-in. round arbor hole.
4-in. size . . . \$1.19 7-in. size . . . \$1.89

Tungsten Carbide-tipped Masonry Drills cut through concrete, brick or marble

Now, the hardest metal known to science has been used to tip these sensational CRAFTSMAN Drills. Now, you can drill up to three inches into concrete, brick, stone, marble, slate or wallboard . . . quickly and surely—much faster than using a star drill. Drills are spiral fluted for fast chip removal. Round shanks fit all ½-inch or larger electric drills or hand and breast drills. Sizes of drills include ¼-inch, 5/16-inch, ⅜-inch and ½-inch. Sold separately or in sets of four.

1/4-in. size . . . 85c 3/8-in. size . . . \$1.10
5/16-in. size . . . 89c 1/2-in. size . . . \$1.39
Save when you buy set of four for only \$3.98

\$3.98

Set of 4

Tungsten Carbide-tipped Drill for long, hard service



Full spiral shank for more accuracy, cleaner boring

Only SEARS, ROEBUCK and CO. sells CRAFTSMAN Tools

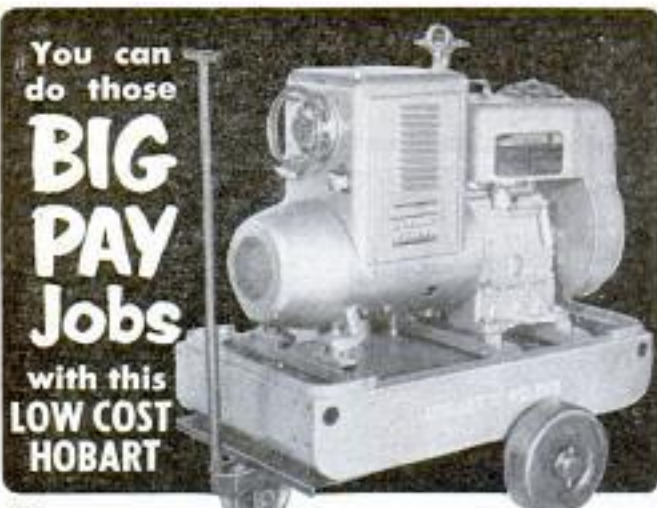

You can do those **BIG PAY Jobs** with this **LOW COST HOBART**

"Husky Boy" air-cooled engine drive arc welder

Welds Anywhere!

In or out of the shop, the "Husky Boy" can earn bigger profits for you. And you save more on the purchase cost. Lighter weight makes it ideal for using on small service truck for quick emergency calls. For use in the shop, wheels and handles are available at a slight additional cost.

Full 200 amps. (not skimped)

Specially built for smaller shops requiring lighter weight and lower investment, the "Bantam Champ" gives full 200 amp.

You can "Build Your Own"

You can save even more by "Building Your Own" with this Hobart generator. Just connect the "Build-Your-Own" to your own used auto engine . . . it's perfect for small operations which do not justify a complete, factory built outfit.

AC Welder with AC Power for tools

The AC-AC Welder and Power Unit lets you do numerous repair jobs where no power is available . . . also furnishes emergency power for electric lights and power tools. 200 or 300 amp. size plus 5KW AC power.

Welding Lessons \$1.00
Complete operator's training course. 200 pages fully illustrated.

AC Transformer type
For improved AC welding performance. Operates on single phase 220 power lines.

HOBART WELDING SCHOOL
Be your own boss! Learn profitable arc welding at the non-profit Hobart Trade School. Skilled instructors give you on-the-job training. Complete or partial courses with latest equipment, G. I. bill approved. Write for free booklet.

HOBART BROS. CO., BOX M-104, TROY, OHIO
"One of the world's largest builders of Arc Welders" Phone 21223

Check these **Low investment HOBART welders too!**



200 Ampere Bantam Champ



Generator for "Building Your Own"



Transformer Type AC Welder

Vest Pocket Guide FREE!

Hobart Brothers Co., Box M-104, Troy, Ohio
Please send additional data on items checked:

"Husky Boy" "Bantam Champ" Welders' Vest Pocket Guide

Transformer Type AC "Build Your Own"

Hobart Welding School

Welding Lessons, \$1.00

NAME _____

ADDRESS _____

CITY _____ STATE _____

Buffalo, Cattle—and now Oil

(Continued from page 109)

rolling hills. This is the country of the last big buffalo hunts in the eighties. The buffalo country gradually turned into range and wheatland. Now, high on a rocky knoll stood a half dozen palomino horses—looking across the valley at a cluster of oil wells.

Pulling up at a throbbing pump that was lifting "liquid gold" from deep in the earth, I asked young Ivan Kohlman how he liked his lonely pump-watching job.

"Fine," he said. "Used to work on a wheat farm, but this job has farming beat all hollow. Fourteen hours a day on the farm, eight at the pump."

The question that may develop into a serious one in the area: How you gonna keep 'em down on the farm—when there's oil or at least an oil job, to be had?

Oil has changed Glendive's way of life for the second time in the current century. Glendive used to be a roaring rendezvous for cattlemen. Cattle raising is still important, but early in the century major interest shifted to dirt farming. And now it has shifted to oil production.

"A trainload of oil pulls out of Glendive daily," reported A. O. Greenwood, retired freight conductor, at his hotel-corner observation post. "When I started working out of here in '17, sugar beets and grain made up the big loads. Since they struck oil here in '51, the population has gone from 4500 to 6000 and they say it'll be 25,000 within the next five years."

Billings is west of the Williston Basin proper but, because of its strategic shipping location, the city has become a major Western oil capital. Already in operation are two huge refineries. At a service station, I talked with attendant Don Nave.

"Got a lot of Texans and Oklahomans up here now," said Nave. "Take a look at the oil section in the business directory of the telephone book. You'll be amazed."

I was. Listed were more than a hundred oil firms. Wyoming and Colorado concerns even carry their long-distance numbers in the Billings directory.

Already, 5,000,000 barrels of oil have been taken out of the basin. That doesn't stack up with Texas production, but development in the Texas fields has been going on for over 50 years. And prospects in the Williston Basin are unusually good.

Ordinarily, oil companies figure that when they start sinking a well in a potentially potent area the odds for striking oil are only about one in eight. Strikes in the Williston Basin, however, have averaged better than one in two. Geologically, the

(Continued to page 264)

Revolutionary new heating system has individual control for each room

Outstanding comfort and economy. Same steam supplies heat and operates turbine-driven room heater fans



Room heating unit is recessed into wall, with only grille projecting. Can be painted to fit any color scheme. Above illustration shows 12,000 Btu unit.

Accurate control of temperature in *each individual room* has long been the goal of heating engineers. Now, with the Iron Fireman SelecTemp system, this is not only possible, but practical and economical. SelecTemp is a unique development in heating, now being enjoyed by thousands of people. Here are a few of the many SelecTemp advantages:

Thermostat in each room. Temperature of every room (including bathrooms) can be varied to fit the preferences of the occupants—and without affecting heat in other rooms. Desired warmth is maintained regardless of changes in outdoor temperature, wind direction or velocity, or of heat from sun or fireplace.

Continuous modulated heat. Each room unit automatically modulates its heat output, ranging from 100% down to 5% of capacity, maintaining a *continuous* flow of filtered warm air. Underheating and overheating, associated with "on-and-off" systems, are eliminated.

Low initial cost. No other system can be so easily and economically installed in new or existing homes or buildings. Costs no more than many systems with only one thermostat for entire house. Small flexible copper tubing (1/4 inch nominal I.D.) carries steam to each room unit. Return lines are 1/2 inch I.D. tubing. Unlike "hard" piping, long lengths of copper tubing, easily bent by hand, are snaked into the walls and around obstructions as readily as electric wiring, with a minimum of cutting and fitting. No electric wiring required for thermostats or fans.

Economical operation. Accurate heat control prevents fuel-wasting overheating. *Unnecessary* heating is eliminated. Rooms temporarily unused can be kept cool, but warmed again very quickly, at any time. Each unit automatically regulates its heat output to compensate for warmth from the sun, fireplace or cooking range.

Locate boiler anywhere. Automatically fired oil, gas or coal boiler can be installed in the most convenient place, and yet will supply the required heat to every room.

Compact, efficient room heaters. Room heater units are only 18 inches high. Three sizes: 6,000; 12,000 and 18,000 maximum Btu output. Each unit contains thermostat, copper

heat transfer core, spun glass air filter, and quiet aluminum circulating fan, powered by steam turbine. Turbine rotor and fans are mounted on the same stainless steel shaft, which turns on self-aligning Graphitar bearings, requiring no lubrication. Filtered air is continuously circulated, with both air volume and temperature automatically varied according to room needs.

Full information gladly sent.

You owe it to yourself to get full information on Iron Fireman SelecTemp heating before deciding on any heating system. Free 8-page illustrated catalog and technical data will be sent you. Just mail the coupon.

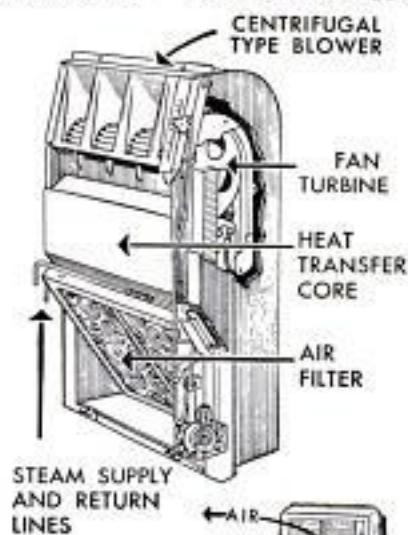

IRON FIREMAN
SelecTemp
TRADE MARK



MODULATING ZONE HEATING

Send for Free Catalog

IRON FIREMAN MANUFACTURING COMPANY
3233 West 106th Street, Cleveland 11, Ohio.
In Canada: 80 Ward Street, Toronto, Ontario.

Please send literature on Iron Fireman SelecTemp heating.

Name _____
Address _____
City _____ Zone _____ State _____



**Floor
Surfacing
Contractors
NEEDED!**

- ★ BIG PAY
- ★ FULL or PART TIME
- ★ AGE No Barrier
- ★ Minimum Investment

Highly Respected Profession Offers You Unusual Opportunity to BE YOUR OWN BOSS

Thousands of men of all ages have found financial security and happiness in a phase of the building and remodeling industry that has become as necessary as the hammer and nails. The pay scale is high for those who are willing to work; many earn \$50 a day and more. No great physical stamina required—men from 18 to 80, even with physical handicaps, enjoy this pleasant year 'round indoor work where earnings are limited only by the amount of time you devote to it. The American Floor Surfacing Machine Co., a 50-year-old pioneer firm and leader in the industry, shows you how to quickly make good in this stable business. No schooling, no special talent or skills required. Only small investment in sander gets you started. Send coupon for "money-making booklet" entitled "Opportunities in Floor Surfacing"—enclose 25c in coin or stamps to cover handling.



AMERICAN
FLOOR MACHINES

SEND 

The American Floor Surfacing Machine Co.
535 So. St. Clair St.
Toledo 3, Ohio

Here is 25c in stamps or coin for booklet "Opportunities in Floor Surfacing", telling me how I can start my own floor sanding business.

Name.....

Street.....

City..... State.....

basin is pretty much the same as oil-saturated Texas or Oklahoma.

"It will take many years and many more wells to explore adequately this tremendous territory," said John E. Swearingen, Standard's general manager of production. "The industry has only begun to scratch the surface."

Actually, the 50-odd oil companies operating in the basin still have several million dollars to go before they get their investments back. A major reason: Drilling in the United States' part of the basin has been deep, some wells going down almost 14,000 feet, which means an outlay of \$350,000 per well. Most wells—7000 to 10,000 feet—cost about \$150,000. In Canada, where oil is being struck around 3000 feet, the cost is only \$50,000.

The deep wells, however, are expected to pay off handsomely, and oil may soon be found in quantity at higher levels. Major oil companies are now pushing pipe-line construction to the big industrialized areas of the Midwest. Eventually it is expected that much of the oil will be used on the spot, giving rise to major centers of chemical and synthetic production.

More than 150 exploration crews are now working in the basin and drilling is going on continually. About 550 wells have been sunk in the United States portion of the basin to date. Of the 350 which have come alive with oil, about three fourths are in North Dakota and one fourth in Montana. Oil was also recently struck in the South Dakota section of the basin.

If you linger long in a basin oil town, you get more excited about possibilities than the natives. Matter of fact, most of the local people take the strikes calmly.

At Baker, Mont., another booming oil town, I talked with L. K. Lathrop, editor of the weekly *Fallon County Times*.

"Yes," he said, "they brought in another gusher on a farm near here yesterday. A few folk went out from town to have a look—but not many. Oil prospecting has been so good around here, it's almost bigger news when they hit a dry hole."

Leaving Baker and heading for Miles City, Mont., I noted beside Highway 10 a familiar cattle-branding scene.

I parked my car to watch. So did some people from Ohio. A woman got out and leaned over the barbed-wire fence.

"May we look?" she asked. "We've never seen branding except in the movies."

A cowboy stamped a hot Y Bar X brand on a calf and grinned:

"Sure, ma'am. Lookin' out here is free."
Oil indeed has changed the vast basin area, but not completely—yet. ★ ★ ★

**RELIEVES PAIN OF
HEADACHE · NEURALGIA
NEURITIS**

FAST

The way
thousands of
physicians
and dentists
recommend



Anacin® relieves headache, neuralgia, neuritis pain fast because Anacin is like a doctor's prescription—that is, Anacin contains not just one, but a combination of medically proven, active ingredients in easy-to-take tablet form. Thousands have been introduced to Anacin through their own dentist or physicians. If you have never used Anacin, try these tablets yourself for incredibly fast, long-lasting relief from pain. Don't wait. Buy Anacin today.

FREE BOAT KIT CATALOG

12 ft.
Runabout
Pictured.

- Assemble your own boat
- No experience necessary
- Save 1/2 to 2/3 "factory built" prices
- Prices include freight and paint



Marine
Hardware,
Fiberglass & Trailers

8' to 14' Models from \$39.25

LUGER INDUSTRIES Kit Division 3207 FREMONT AVE. SO. MINNEAPOLIS 8, MINN.

BUILD FINE GRANDFATHER CLOCK NOW
The simple sensible Red-Red-Way us thousands have — **SAVE HALF. SHOP TESTED PLANS "SPIRIT OF THE CENTURY"** Narrow waist 80" tall or stately straight side **"SPIRIT OF AMERICA."** **EASY-TO-FOLLOW** plans tell all—plus **BROCHURE** of heavy brass weight Westminster, tube chime movements, porcelain dials, 24" solid mahogany case kits. Send \$1.00 today — Both plans \$1.50 NOW. **KUEMPEL CHIME CLOCK CO., 27 Kuempel Bldg., Minneapolis 16, Minn.**

Wholesale! TOOLS! GUNS! CAMERAS!

BUY TOOLS, PHOTO EQUIPMENT, SPORTING GOODS, JEWELRY AND THOUSANDS OTHER. NATIONALLY ADVERTISED PRODUCTS AT BIG DISCOUNTS. SAVE ON OWN PURCHASES. BIG PROFITS SELLING TO OTHERS. POSTCARD BRINGS FREE COPY "THE WHOLESALE PLAN."

AMERICAN BUYERS SERVICE
629 Linden Ave., Dept. 15, Buffalo 16, N.Y.

Get up to **40% off**



EARN YOUR OWN KING MIDGET. We want rider agents to demonstrate and sell the World's Lowest Priced Automobile. Fully assembled or bolt together parts. If there is no dealer near you send 25¢ for detailed literature with agents proposition, or \$1 (refund first order) for this plus actual assembly book and service manual. **MIDGET MOTORS MANUFACTURING CO., ATHENS 1, OHIO**

FOR THE FASTEST "NEXT SHOT"
MARLIN 336

IS YOUR NUMBER!



Marlin Side Ejection throws spent cartridges out the side . . . out of harm's way, out of your line of sight . . . not up in front of eyes.



Lowest Center 'Scope Mounting. Marlin side-ejection design and low hammer spur permit lowest possible mounting of 'scope sights.



Marlin's Matchless Lever Action works as quick as you can flick your wrist . . . a major achievement in engineering design.

Write your own ticket! There's a Marlin 336 to meet your specifications. Calibers 30/30, .32 Spl. and .35 Rem. Rifle, carbine and sporting carbine models. Sold throughout Canada, too.

*Prices slightly higher west of Rockies.

THE NAME FOR GAME
Marlin
FINE GUNS SINCE 1870

VALUABLE COUPON — MAIL TODAY
The Marlin Firearms Co., Dept. 10-PM
New Haven, Conn.
Send me catalogue with information and photo-illustrations of Marlin Guns. Also send a pack of (please check) single or double edge Marlin Razor Blades. I enclose 10¢ for handling.

Name _____
Street _____
City _____ Zone _____
County _____ State _____

"All that oil in Texas

... and not a drop in my crankcase!"



Doctor drives over 200 miles with NO OIL in crankcase!

"Before driving from San Antonio, Texas to Nashville, Tenn.," writes Dr. W. F. Buckley of Marietta, Ohio, "I stopped for gas, an oil change and a grease job. That night, I drove hard to Dallas, over 200 miles away. My dashlights were off and, since the motor didn't overheat, I did not check my oil pressure. Imagine my surprise when I found the station attendant in San Antonio had drained all the old oil, but had not added any new! My car had been lubricated for 200 miles only by the thin, protective Pyroil film which had remained in the engine. And I can truthfully say that my engine was unhurt in any way — thanks to Pyroil!"*

This was a freak situation . . . in all probability, your engine will never have to undergo such a grueling test. Yet Dr. Buckley's experience does emphasize the fact that, herculean task or normal driving, Pyroil will keep your car running smoother longer, and for very little money. Use Pyroil "A" in the gasoline and Pyroil "B" in the crankcase.

World's First Additives, Always the World's Finest!

PYROIL "A"

Complete Upper Engine Lubrication *Only 25c*

PYROIL "B"

Complete Crankcase Treatment *Only 79c*



- Prevent pre-ignition and dry starting • Free hydraulic valve lifts • Protect against rust, friction, acid corrosion • Lubricate all vital engine parts • Save gasoline, cut maintenance costs • Increase compression, restore power • Clean out sludge, prolong engine life

IT PAYS TO PYROILIZE!

For summer-smooth driving all winter long . . .

New Winter FROSTFREE PYROIL "A" and "B"

40° Below Zero Protection!

★ Pyroil Frostfree "A" — gasoline anti-freeze and upper engine lubricant

★ Pyroil Frostfree "B" — crankcase super-lubricant plus anti-condensation

THE PERFECT PAIR FOR MOTOR CARE!

Sold by leading gasoline stations, garages and automotive stores in Canada, Cuba and most foreign countries.

Write for descriptive literature.

*This is just one of hundreds of testimonials on file at Pyroil's main offices and available for inspection.

PYROIL COMPANY, INC., 278 PYROIL BLDG., LA CROSSE, WISCONSIN

At Home, 2004 A.D.

(Continued from page 156)

result in three-level use of a lot—living below the surface, landing on it and doing most of our traveling above it."

Laszlo's theories are not to be taken lightly, because his background makes him highly qualified to forecast future trends. Born in Hungary, a member of a family of furniture manufacturers, he got an early start on a designing and decorating career. He opened his first office in Vienna in 1923 and, when he moved to Berlin shortly afterward, quickly established an enviable reputation as a creator of commercial buildings, residences, interiors and industrial products during the pre-Hitler period when Germany was a world center of modern architecture.

Emigrating to America in 1936, Laszlo continued to develop a design for living he had helped originate, one combining beauty, comfort and convenience, making use of relatively simple and inexpensive materials and expressing itself in one-story houses, informal plans and highly developed outdoor areas.

The majority of architects design homes as buildings—making the plans, outlining the details, getting a contractor to build them and leaving the interiors up to the owners. Laszlo does things differently. His houses are completely planned from construction site to lighting, furnishing, color and accessories, and he stays with each one until the last detail is completed.

He predicts that the highly organized society of his futuristic suburbia will prohibit individuality as far as selection of homesite is concerned, but that there will be much to compensate for this loss.

He sees the home of the future with a steel and concrete "mechanical core" roof, carrying a series of tubes to provide every possible utility, facility and service. This system will include telephone, water and sewer connections plus a supply of atomic energy for heating, lighting and power coming from a central source.

Concrete uprights are set around the Laszlo house of the future. The side walls are set at an angle and the interior is divided into two sections—one containing kitchen and dining facilities, the other bedrooms, baths and storage facilities. Between the two is a play area on the side near the main yard. Although maximum floor space will be fixed by the site, interior decoration will be individual except for some walls and service elements that will be prefabricated for economy. Individually designed partitions and furniture, as

(Continued to page 268)

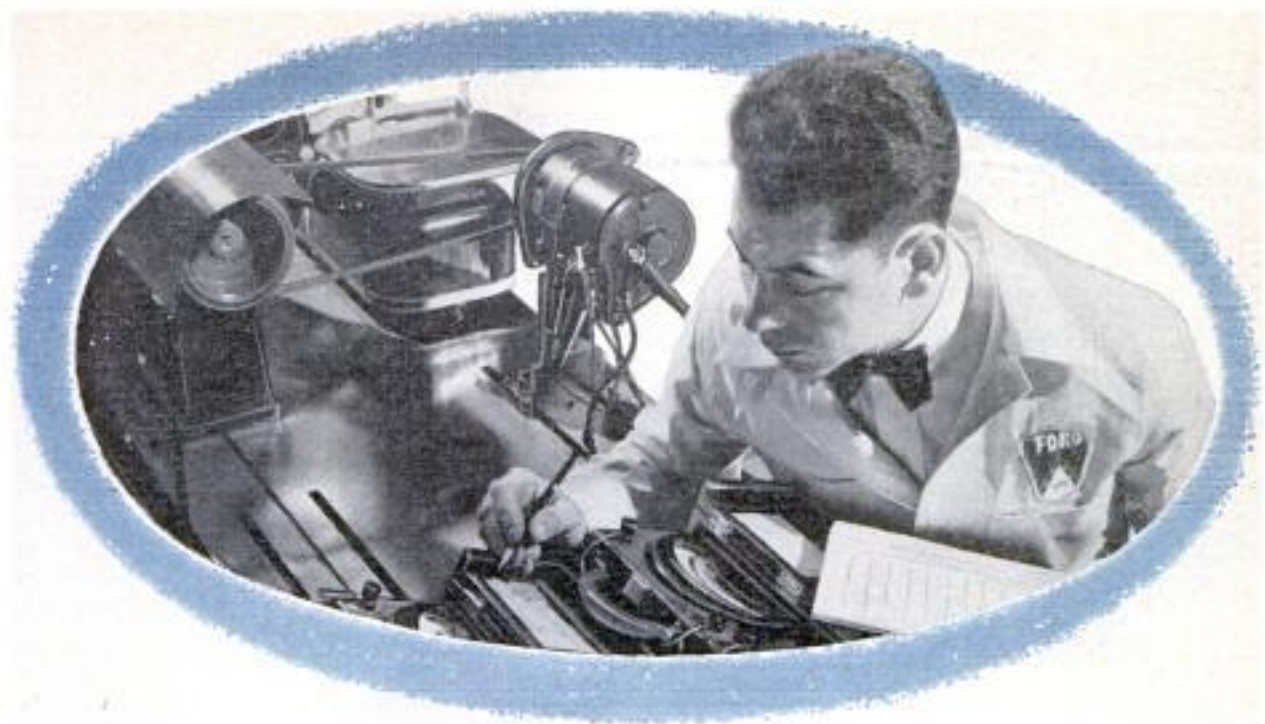

**Who puts
the "Genuine" in
Genuine Ford Parts?**

The same men who originally built your Ford set the specifications for Genuine Ford Parts. This means they're made right for your Ford, to fit right to last longer.

The way to keep your Ford running like new, even though replacement parts are called for, is to always get new parts that you *know* are made *especially* for Fords. This means *Genuine Ford Parts*. Every Genuine Ford Part is made to *exact* Ford specifications, and put through gruelling tests by Ford engineers, both in laboratories and test tracks, before they're approved for manufacture. That's why we say:

WHEREVER YOU GO, INSIST ON

OCTOBER 1954



2 new Starrett MICROMETERS

to help you do
a better job of
precision measuring



221

hi-precision
MICROMETER CALIPER

Reads direct in
ten-thousandths — no
Vernier to decipher.
Makes every measurement
with exactly the right
pressure — no relying on
"feel". Range 0-1" by
ten-thousandths.
Write for folder.

mul-t-anvil
MICROMETER
CALIPER



220

Permits quick, accurate
measuring of tubing,
cylindrical walls, from
notes or slots to an edge, as a
height gage, etc. Furnished with
interchangeable rod and flat
anvils. Range 0-1" by thousandths.
Write for folder.

an outstanding feature of
all STARRETT micrometers

balanced design

means every detail precisely right for better, faster precision measuring. Only Starrett Micrometer Calipers give you 12 big features all in perfect balance for (1) Easy Handling (2) Faster Measuring (3) Easy Reading (4) Lifetime Accuracy. Ask your industrial distributor to demonstrate the superiority of Starrett Micrometers.

FREE STARRETT CATALOG FEATURES NEW TOOLS

Catalog 26A contains new tools section plus 300 page display of the complete line of Starrett precision tools, dial indicators, steel tapes, hacksaws, band saws, band knives and precision ground flat stock. Write for it. Address Dept. AP



THE L. S. STARRETT COMPANY · ATHOL, MASS., U.S.A.



MECHANICS' HAND MEASURING TOOLS AND PRECISION INSTRUMENTS
DIAL INDICATORS • STEEL TAPES • PRECISION GROUND FLAT STOCK
HACKSAWS, BAND SAWS and BAND KNIVES

well as varied use of the overhead lighting and heating panel, will be matters of personal choice.

Automatic appliances plus advances in community child care will provide the housewife of the future with a great deal of spare time. Shopping will be simplified by selections being made from displays televised in color and 3-D. Deliveries will be made via a city-wide pneumatic tube system. Anything that can't be delivered or picked up pneumatically, such as clothing that has to be fitted or rugs and drapes that must be measured, will be handled through small stores on wheels.

Despite increased population, beaches will be less crowded than today. The bathroom as we know it will be a thing of the past, and bathing will have come out of the dark. Revived along ancient Roman lines, it will have become as refined and traditionalized as it is now in Finland and Japan. Americans in the atomic age will enjoy a bath in spacious, glass-enclosed areas open to the light, heat and health-giving rays of the sun, with adjacent outdoor pools.

Laszlo's home-of-the-future contains 1800 square feet. His house could be built today, exclusive of such innovations as atomic energy and pneumatic-tube connections, for about one third more than the cost of a conventional home. Fifty years from now it will cost much less.

"There's no doubt that prefabrication will become widely accepted," he asserts, "because it is the answer to the price problem. When building costs are high and attempts are made to build cheaply, the slums of the future are created. Today's big housing projects mark the beginning of a trend toward standardization which means steady progress in prefabrication. The privacy of a design such as mine eliminates one of the objectionable features of mass housing. Eventually, we'll have completely prefabricated communities."

Of course, Laszlo doesn't want to stick out his neck and say that he expects his forecast to bear fruit inside of 50 years, but there are good reasons to assume that it will. Those who regard it as fanciful should be reminded that 50 years ago much of what is commonplace today could be found only in science fiction. Certainly, scientific progress during the next half-century should be greatly accelerated by atomic research.

It's more than possible that Paul Laszlo's predictions are actually quite conservative, that they represent only a small part of what will have become reality by 2004. Science is now standing on the threshold of a new era. ★ ★ ★

Home "Fix-it" Tips



Plastic Wood permanently repairs furniture, replaces rotted wood, and fills knot holes and gouges. Apply it like putty—it hardens into real wood.

YOU NEED "PLASTIC WOOD"

Carpenters' NAILPULLER Pocket size!

Powerful, Easy to Use, Handy as a Hammer!

Satisfaction guaranteed up to tenpenny nails.

POSTPAID U.S. ONLY

\$174

No C.O.D. No Stamps.

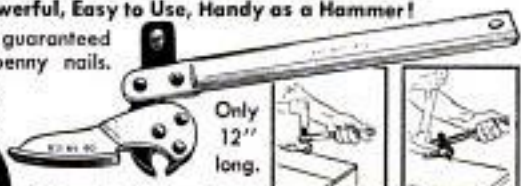

Carpenters' favorite. Convenient in tight places, carries in pocket. Tool steel counteracting jaws driven into wood under nailhead. Double leverage with hammer. All steel, rustproofed.

K-D Mfg. Co., 526 N. Plum St., Lancaster, Pa.

LAWN ORNAMENT-NOVELTY PATTERNS

28 Lawn Ornament Patterns, 25c. Other Patterns; 15-20" high; Dutch Girl, Dutch Boy, Pirate, Bull Terrier, Mexican Girl, Mexican Boy, Dwarf, Penguin, Flower Girl, 15c each. 25 Novelty Patterns, 30c. All 62 Full Size Patterns, \$1.00.

Strother Pattern Service, Dept. DR-8, Box 128, Belington, W. Va.

Treasure - Minerals - COINS

Easily located with new Light-weight M-Scope Detector. Superior performance, lowest price, monthly payment plan.

FREE LITERATURE
FISHER RESEARCH LAB., INC.
PALO ALTO CALIF.

make your own Gems 29.50

The Gem Maker comes complete with all necessary equipment, including a super-charged diamond blade for sawing, and all wheels for grinding, shaping and polishing; also complete instructions. The complete equipment as shown, less motor and belt, for only \$29.50, f.o.b., Burlington, Wisconsin. Write today for information and literature.

B&I MANUFACTURING CO.
Dept. S Burlington, Wis.

MAGNETS 225^{lb} PULL

GENUINE ALNICO - NEVER WEAKENS

AMAZING, PERMANENT MAGNETS—WILL NOT WEAKEN! NON-ELECTRIC Retriever guns, tackle, tools and other steel items from lake, river, plating tanks, drains or other hard-to-reach spots. Recover drills, tools, etc. from sweeping. Clear alley of harmful tanks, nails. Many other uses. Pays for itself quickly. GUARANTEED. Try any magnet one week. Money refunded if you are not well pleased.

No. M-725 (Weights 34 oz.) Has pull of 225 lbs. on steel block. \$15.00
No. M-675 (Weights 40 oz.) Has pull of 175 lbs. on steel block. \$10.50
No. M-650 (Weights 41 oz.) Has pull of 150 lbs. on steel block. \$ 8.50
No. M-500 (Weights 15 oz.) Has pull of 50 lbs. on steel block. \$ 4.00
No. M-30 Holistic assortment of six small magnets. \$ 1.50

Send Money Order or Check. We pay postage. No C.O.D.'s.
MIAMI MAGNET COMPANY, 3240 N. W. 27th Ave., Miami 42, Fla.

B.F. Goodrich RUBBER FLOOR TILE



MAKE THE TOUCH TEST

... feel how Super-Density — the exclusive feature of B. F. Goodrich Rubber Floor Tile — provides a smoother surface which eliminates dirt-catching pores, makes floors easy to clean and keep clean!

AND YOU'LL WANT TO DO THIS —



INSTALL IT YOURSELF

Use the special 80 gage thickness for homes . . . and the handy B. F. Goodrich Self-Installation Kit.

Send for FREE full color folder.



B. F. Goodrich Co., Dept. PM10, Flooring Div., Watertown 72, Mass.

NAME.....

ADDRESS.....

CITY.....STATE.....

YOU CAN START A

**\$40 A DAY
BUSINESS
IN YOUR SPARE TIME**



Andy Phillips says:
"MyBELSAW Sharp
Smith gives me big
profits at low ex-
pense — I can run
35 to 40 circular
saws in an 8-hour
day — that makes
me \$40 cash."

"I also get **BIG EXTRA PROFITS**... up to \$4 an hour... by grinding planer and jointer knives — there's always a demand for this kind of work."

You can start this **REPEAT CASH** business in your own home or garage while you are working at your regular job. Easy to operate, no experience needed. "Pays for itself from just 65 jobs." — *Harvey Jensen*

For as little as \$15 down payment, you can get your **BELSAW SHARP SMITH** rushed to you.

FREE book tells how

YOU can start making money the very day your **BELSAW SHARP SMITH** arrives. Earns \$4 to \$5 an hour in your **SPARE TIME** sharpening and setting circular saws for builders, lumber yards, factories... Plus **BIG EXTRA CASH**, precision grinding planer and jointer knives, plane irons, wood chisels and drill bits. Hundreds of jobs in your own neighborhood. No extra equipment needed, no canvassing. Send today for your Free copy of "Life-Time Security."



BELSAW MACHINERY CO

3706 Field Building

Kansas City 11, Mo.

send for **FREE CATALOG**

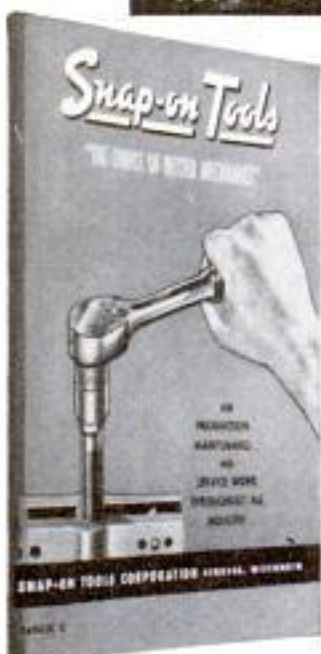

America's Foremost
money-making
**MECHANICS'
TOOLS**

It's easy to own the same "pay-off" tools used and endorsed by America's top-earning mechanics throughout the automotive, aviation and industrial fields! Snap-on tools help you handle every repair job faster, easier, better. And they **LAST**... pay for themselves over and over again! Start building your own tool set now with basic Snap-on units—add others any time. Genuine Snap-on tools are never sold in stores—direct to users only. Mail coupon for free catalog.



Snap-on Tools Corporation
8062-J 28th Ave., Kenosha, Wis.

Send me free catalog. Occupation _____

Name _____

Address _____

City _____ Zone _____ State _____

**Is the Old Homestead
Worth Saving?**

(Continued from page 176)

peeling of paint on a frame house may mean that there is excessive condensation of moisture on the walls.

This leaves the roof as the main structural element now to be examined. Sight along the slope for obvious sagging. Look for deterioration of roof covering and metal flashing, gutters and downspouts.

Floor plan. The floor plan is important in an old house, not so much for what it is as for what it can be. In the typical house used as an example by Martling, the floor plan was promising. Although badly arranged before remodeling, it was adaptable to changes which did not involve extensive structural alterations.

Easy access from the front entrance was developed, so that the living room could be used as an entertainment area rather than as a mere corridor between sleeping and eating areas.

First-floor powder-room facilities were located to give maximum convenience and utility, yet complete privacy from the main sections of the house.

Before remodeling, this typical house had a porch which served no useful function other than as an observation post to study the comings and goings of neighbors and passers-by. A new screened-in porch was placed to give maximum enjoyment of the family's private garden.

Economics of the remodeling. There are two approaches to the problem of whether it is economical to remodel a home. If remodeling is being considered by the present owners they must compute the dollar expenditure as follows: To the initial cost of the house, add the remodeling cost. Then take into consideration the dollar value of the use already obtained from the investment. Weigh carefully the desirable factors of congenial neighbors and good location. Balance these against the cost of obtaining a similar new house. In many cases, where a family has lived in a home for many years, it has already paid for itself by providing economical shelter at a reasonable cost per annum. The additional cost of remodeling is, in this case, much less than the cost of buying a new home, and it is therefore more sensible to remodel than to start fresh.

In a case where a family is considering buying an old home and remodeling it, the same reasoning applies, except that the initial cost is apt to be higher and there is no offsetting figure for value received.

(Continued to page 272)

GUIDE YOUR BOY TO SCIENCE WITH GIFTS ELECTRICAL

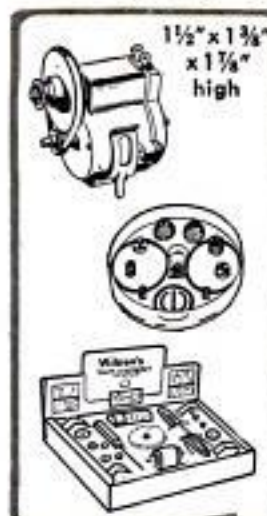

1½" x 1¾"
x 1¾"
high

It is not too early to think about the gift season ahead—to plan to give Wilson's battery-operated motors and accessories to your boy of any age. The interesting, instructive, character-molding gifts listed below are fully described in our catalog. Write for free copy today—plan now and save last minute disappointment.

- No. 3-100—Tiny Atom Motor, 1½-3 V. \$2.00
- For higher voltages \$2.50
- *No. 5002—2-speed metal motor \$3.00
- No. 96—Open steel frame motor with gear, pinions, pulley and worm \$4.00
- No. 3113—Tiny Atom motor assembly kit with many accessories \$3.00
- No. 1300—Small accessories kit \$1.00
- No. 3700—Large accessories kit \$3.00
- *No. 4000—Deluxe set, kit with motor \$5.00
- No. 700—Super-Power kit with motor, speed reducer, all accessories \$10.00
- *No. 88—Kit of 8 pulleys—2 belts \$2.00
- No. 3000—Variable speed gear unit \$4.00

All Wilson's motors have Permanent Aisco V Magnets. Catalog FREE on request.

Result with order and we pay postage in U.S.A. No C.O.D. Add 2% Sales Tax for delivery in Ohio. Write Dept. PM.

For quick delivery see your local dealer — or order direct



WILSON'S OF CLEVELAND

425 Lakeside Ave., N.W. • Cleveland 13, Ohio

IN THE GARAGE

Keep an extra can in the garage for oiling car doors, generator, distributor, etc. Highly penetrating 3-IN-ONE makes things run better—last longer.



"3-IN-ONE" OIL

VALUE
"PLUS"



Extra value is built into every Gerstner Chest. Ask the men who use them. Free Catalog.

GERSTNER TOOL CHESTS

454 Columbia St., Dayton 7, Ohio

Say You Saw It in Popular Mechanics

BURKS

SUPER TURBINE
PUMPS
LAST
LONGER

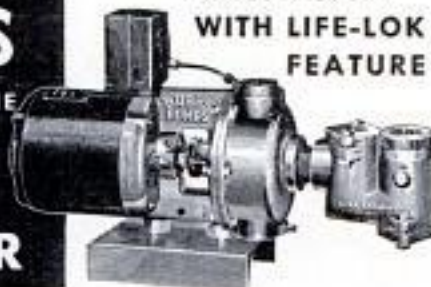

ONLY PUMP
WITH LIFE-LOK
FEATURE

Thanks to the LIFE-LOK feature, the BURKS Super Turbine Water System lasts up to 40% longer than any other kind, delivers more gallons per minute and provides "like-new" performance and efficiency when other types would be worn out. It's completely automatic—self-priming.

FREE BOOK PICTURES PUMP DETAILS

Send today for "The Story of Burks"—a 32-page book giving detail drawings, graphs, etc. See why BURKS is finest engineered system . . . why it delivers more water per hour . . . why it's the finest water system you can buy. Write to—

DECATUR PUMP CO., 61 Elk St., Decatur 70, Ill.

FREE

SEND FOR THE

1955

308-PAGE

value-packed **ALLIED**
TV & RADIO CATALOG
world's most complete
ELECTRONIC SUPPLY GUIDE



Everything for Experimenters,
Builders, Amateurs, Servicemen,
Engineers & Hi-Fi Specialists

Get ALLIED's big 308-page Catalog featuring the world's largest selections of latest top-quality electronic equipment at lowest, money-saving prices. See the newest in custom TV chassis, antennas and accessories; FM and AM tuners; High Fidelity systems and components; recorders and phono equipment; Amateur supplies; test instruments; builders' kits; industrial electronic supplies—plus thousands of parts, tubes, tools and books. Get everything, get more for your money—send today for your FREE 1955 ALLIED Catalog!

SAVE ON
EVERYTHING



WORLD'S
LARGEST
STOCKS

Ultra-modern facilities to
SERVE YOU BEST

Send
for FREE
Catalog

ALLIED RADIO

ALLIED RADIO CORP., Dept. 5-KK-4
100 N. Western Ave., Chicago 80, Illinois

Rush FREE 1955 ALLIED 308-Page Catalog.

Name _____

Address _____

City _____ Zone _____ State _____

Family needs and preferences. Just as in any planning, whether it is for a new or a remodeled house, the family needs must be analyzed.

Here are some of the points Martling considers in this phase of the planning: General standard of living, mode of living, work and play habits, age and family composition.

The growing scarcity of household help, the trend toward more home entertainment, the widespread preference for informal serving of meals all are having profound effects upon the architectural arrangements of new and rebuilt homes.

Esthetics of remodeling. The style of the remodeled home is influenced by several factors, Martling says. It may be possible to retain the same basic style, cleaning it up design-wise, and keeping costs to a minimum. It may be necessary to scrap the old style entirely, since many old houses have no particular design lines to follow. When this point is reached, it is wise then to consider family preferences. Do they have traditional furniture which is too good to be junked? Do they like only Early American furniture and architecture? Or do they admire sleek, contemporary lines? If their preferences run along the modern design line, does this style fit into the neighborhood?

Martling states that the test of a successful remodeling is this: Is it possible to determine where the new work starts and the old leaves off? The entire house should have a look of unity.

Another test for a good remodeling is: Will the style be as pleasing 10 or 15 years from now as it is at the present time?

Martling warned against fads in architecture. The efforts of a few years back to squeeze human beings into homes that were "machines for living" showed up in some cold and now-dated architecture. Enormous picture windows placed awkwardly, where they showed a view of nothing perhaps but the neighbor's picture window, porch or garbage cans, were a good example of such a fad. All-glass walls, all-in-line architecture, flat roofs and other trick devices may bring down the resale value of a remodeled home.

Martling also stressed the desirability of planning the remodeling as a whole, even if you intend to do only part of the work now. This may save you great expense at a later date when you might otherwise have to "alter alterations." Families sometimes try to skimp on construction in order to buy home furnishings. This may not be a wise decision. Over-all planning of the remodeling will help you to decide. ★ ★ ★

**"R" IS FOR
REMOVABLE!**



R.O.W. windows were the first removable windows to be widely accepted. The patented, trouble-free mechanism, plus quality construction, has been responsible for R.O.W. windows' remaining America's favorite. Insist on genuine R.O.W. windows.



Look
for
the
cups!

See your local lumber dealer or write R. O. W. SALES CO., 1340-80 ACADEMY AVENUE • FERNDALE 20, MICHIGAN

R.O.W. is the registered trade-mark of the R.O.W. Sales Co.



THE HEAD CAN'T FLY OFF! Estwing "Unbreakable" hammers and hatchets are forged in one piece from tough tool steel. Grip is genuine leather, proven most comfortable and durable. Used by the carpenters for 30 years. Ax \$4.50, hammer \$3.65. At all leading hardware stores. Write for FREE catalog. **ESTWING MFG. CO** Dept. P, Rockford, Ill.

WORLD'S BEST SMALL TRENCHERS



Portable DITCH-WITCH digs 2" to 6" clean, even ditches to 36" depth in all types of soil. Complete unit—self propelled—outdigs 8 men. Four rugged models.

Write for illustrated literature. **CHARLES MACHINE WORKS** THE 620 B Street Perry, Oklahoma

BREAKS THE GRIP OF RUST



KROIL, the amazing chemical lubricant, creeps into millionth inch spaces and loosens frozen metal parts when all others fail. Used by 12,000 leading industrial shops.

Try KROIL on money back basis—gallon \$3.85 FOB factory—or send \$1.50 for two 8 oz. spout cans—Postpaid.

KANO LABS.

1032 THOMPSON LANE
NASHVILLE 11, TENNESSEE

MAKE BIG MONEY

Sharpening Lawn Mowers...

SPARE OR FULL TIME

Mr. C. E. Hardy of Missouri says, "I am doing a fine business with the Universal Grinder. One Customer sends another. I spent 40c for a newspaper ad and have done nearly \$500 worth of business." G.E. of Ark. says, "I have had my Universal Grinder 2 months and made a net profit of \$227."



ONLY ON THE UNIVERSAL LAWN MOWER GRINDER

... can the inside face and edge of the stationary blade, as well as the reel blades, be ground to proper clearance **ALL IN ONE SET-UP**, without removing any blade from either hand or power mower. **Send Today for Free Details.** **ROGERS MFG. CO.** Dept. M-104 **LINDSEY, OHIO**

the **ONE**
shock absorber
that makes
EVERY car
RIDE BETTER
DRIVE SAFER

DISCOVER THE THRILL

... of driving at today's high speeds down a super highway smoothly, steadily—without the annoyance of wander or side-sway.

... of taking sharp curves easily, safely even though you come upon them unexpectedly.

... of gliding over rough spots or washboard sections without the bounce and wheel-fighting that often leads to loss of control.

... of settling down quickly after crossing railroad tracks or ruts.

... of being sure of better control on soft shoulders—and even in the event of a blow-out.

... of being able to stop suddenly without lurches.

... of driving mile after mile, hour after hour without strain—sure of control.

The one Shock Absorber that meets both Heavy-Duty and normal driving requirements in one unit.

Learn the facts about this new Shock Absorber principle...

Write for Free Booklet **HECKETHORN MFG. & SUPPLY CO.** Dept. PM-2—242 W. Main Littleton, Colorado



COLUMBUS
Luxury-ride SHOCK ABSORBER

HECKETHORN

LICENSED BY HE. CARRON

Available at **BETTER AUTO PARTS DEALERS EVERYWHERE**

IT'S SO EASY TO INSTALL SHATTERPROOF



TRANSLUCENT BUILDING PANELS



Strong, shatterproof Corrugulux can be quickly sawed, drilled and nailed to light-weight framing with ordinary tools. Corrugulux gives your garage glamour and cheerful light. It's weather resistant—long lasting.



FOR PATIO PORCH

Corrugated Corrugulux makes a lightweight, strong roof for your patio or porch. Corrugulux softens harsh direct sun rays without darkening inside rooms. Each panel is reinforced with fiber glass.



Add translucent beauty with a Corrugulux wall partition, movable screen, or bath enclosure. Thirteen colors, corrugated or flat sheets. Economical. Easy to clean. It's shatterproof—so important with children.

SEND
10c FOR
CORRULUX
DO IT
YOURSELF
PLANS KIT

Corrugulux Division
Libbey • Owens • Ford • Glass Co.
P. O. Box 20026
Department PM 10-54
Houston 25, Texas

Gentlemen:
Send Do It Yourself Plans Kit
with instruction details for
Patio Roof Room Partitions
Carpents Skylights
Breezeways Sidelights
Enclosed is 10c to cover cost.

Name _____
Address _____
City _____ State _____

they expected to build the house completely themselves; 22.7 percent said they would contract for the foundation, plumbing, heating and electrical work and would build the balance themselves; 21.6 percent said they would have a contractor build the shell and finish the interior themselves. This represents a total of 60.8 percent who would do all or part of the work themselves. The cost of materials for this house in the Chicago area (one of the highest-priced regions in the nation) is estimated at approximately \$9000. To have the house built by a contractor in the same area is estimated at \$23,350, not including lot.

Of course, the cost of the house will vary with local labor costs, the type of fixtures used, quality and prices of many materials and whether one-car garage or two. In the Long Island-New Jersey area the contractor's price for this same house is estimated at \$17,000. In some sections, particularly in the South, the house can no doubt be contracted for even less.

The Chicago-area cost figures are presented merely as a guide. In fixing the amount to be spent on the house, the architect and the editors of this magazine were influenced by the fact that the majority of those answering the survey indicated they would like to do some work on it themselves. For example, if a family can afford to spend \$12,000 and the materials cost \$9000 they would be able to spend \$3000 on outside labor and must do the balance of the work themselves. A reader of South Bend, Ind., wrote: "I would be able to invest around \$10,000 which I figure would be comparable to a house costing \$18,000 to \$20,000 built by a contractor." As revealed by the percentage chart, 39.2 percent would have the house completely built by a contractor. This, of course, would make it a much more expensive home.

The wall-to-wall closets and sliding doors reflect the wishes of many readers.

A man from Sundance, Wyo., wrote: "An attached garage should not open directly into the house, but should connect by a short, protected path outside." This demand was repeated by many others, including a man from Kirkland, Wash., who said: "The garage must be connected to the house by an overhead cover." Matern not only provided this in the plan, but a "rainy day" entrance to the porch from the front of the garage.

For every detail of this house, both architect and editors have been ruled by the results of the survey. Otherwise, what we have presented might have been an "architect's house" or an "editor's dream" instead of "the house you asked for."

Like it?

★ ★ ★

CLAMP FIXTURE No. 600



Fits 3/4" pipe, can be applied to any length. Easy to assemble. Hardened steel cam holds tight, releases easily. Made of best malleable. Also wood bar and 1/2" pipe clamp fixtures available.

At Hardware Dealers Everywhere. Write for Catalog of Complete Line



HARGRAVE

1987 WAVERLY AVENUE
CINCINNATI 12, OHIO

The Cincinnati Tool Co.

Erect it yourself and **SAVE!**



- Easily assembled
 - Steel or Aluminum
 - Garages & Bldgs. for all purposes
 - Shipped Anywhere
- \$279 UP**

Write for Folder

JOHN COOPER CO., 306 2nd St., HACKENSACK, N. J.

NEW WAY TO CUT PERFECT GROOVES WITH CIRCLE SAW!



Just dial any of 40 cuts. Parallel, clean, no sanding! Leave on saw for regular cuts. For 1/2, 3/4, 3/8 and 1" arbors. At dealer's or order direct!

Only **\$495**
Per Set

WARREN DADO WASHERS CO.

Dept. #30 P.O. Box 98, Detroit 2, Mich.

\$6.95 DRAINS cellars, cisterns, wash tubs; **IRRIGATES - CIRCULATES - SPRAYS**



1,001 USES—HOUSE, GARDEN, FARM
Original All-Purpose Pump has 2500 GPH capacity, 360 GPH 75' high; or 1500 GPH from 25' well. Use any 1/6 to 1/2 HP motor. Stainless steel shaft, 1" inlet, 3/4" outlet. Motor coupling included.

DOES NOT CLOG OR RUST!
Postpaid if sent with order. (West of Miss. add 50c.) **MONEY BACK GUARANTEE.** Larger Centrifugal Pumps, and Gear Pumps in all sizes.
LABAWCO PUMPS, Belle Mead 7, N. J.

\$495
less battery

FLOODLIGHT!

It shoots a brilliant, 800-ft. spotlight—a widespread floodlight! It's sturdy, it's economical, it's so very handy! Don't be without one. Uses 6 V. battery. See your dealer.

DELTA ELECTRIC CO.
Marion, Indiana



SPOTLIGHT!

Delta Powerlite
2-LITE ELECTRIC LANTERN



WARNING!

Insure now against Anti-freeze loss and engine overheating

1. CLEAN OUT RUST AND SCALE WITH NEW IMPROVED DU PONT COOLING SYSTEM CLEANSER

To prevent costly spill-over and boil-away, clean out your radiator *before* adding anti-freeze. Du Pont Cooling System Cleanser gets rid of rust, scale and grease quickly, safely, surely. No reverse flushing necessary.



2. PREVENT LEAKS AND SEEPAGE WITH DU PONT COOLING SYSTEM SEALER

Your cooling system may *seem* watertight, yet still have tiny pinholes through which permanent anti-freeze can "creep." To eliminate the threat of this wasteful seepage, simply pour Du Pont Cooling System Sealer into your radiator. It finds and closes the holes... can't clog or harm hose or metal parts.



ASK ABOUT THE COMPLETE DU PONT PRE-ANTI-FREEZE SERVICE
at your service station or car dealer today
and assure trouble-free driving this winter.

DU PONT No. 7. PRODUCTS
From Chemical Research... For Easier Car Care

DU PONT

BETTER THINGS FOR BETTER LIVING... THROUGH CHEMISTRY

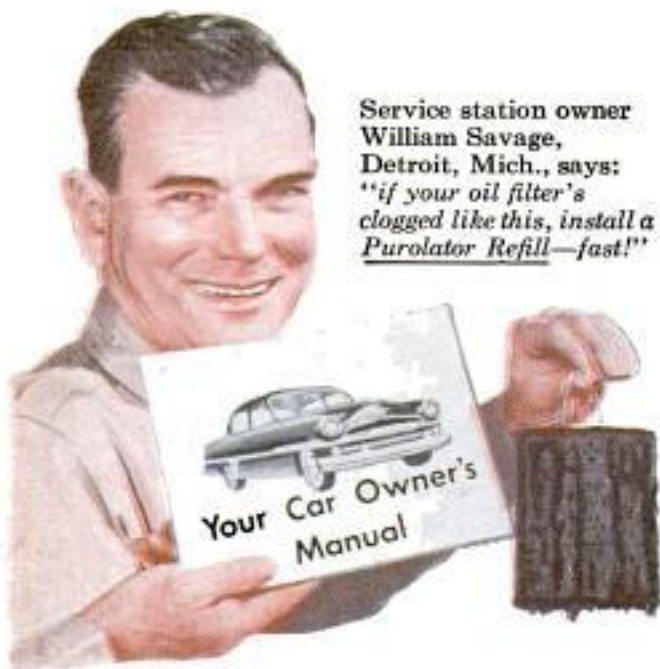

Service station owner William Savage, Detroit, Mich., says: "if your oil filter's clogged like this, install a Purolator Refill—fast!"

"Look, the book that came with your car* says—

Change your Oil Filter every 5,000 miles"

***17 out of 18 leading car makers recommend oil filter changes at least every 5,000 miles, on the average, depending on driving conditions.**

Grit and sludge in the oil can ruin your engine . . . run up expensive repair bills. Stop them from damaging delicate engine parts by putting in new Purolator Oil Filter Refills regularly.

If you've driven 5,000 miles since changing your oil filter, it's probably clogged. Install a new Purolator Micronic Refill—right away! Costs as little as \$1.60. *More car makers specify Purolator than any other oil filter.*

PurOlator

World's finest **OIL FILTER**

"We use Purolators for all the cars we service," says Mr. Savage.

IT PAYS TO CHECK YOUR OIL FILTER EVERY TIME YOU CHANGE YOUR OIL



*Purolator,[®] "Micronic"[®] Reg., U. S. Pat. Off. Purolator Products, Inc., Rahway, N. J.; Toronto, Canada

Would You Build It Yourself Again?

(Continued from page 164)

on it was catch-as-catch can. I didn't stick to the plans. I put in two fireplaces that weren't there and consequently had to change the basement stairs. In fact, they're going to be a little steeper than normal. If it is possible to get plans that suit you, I'd say you should stick to them.

Q: How did you handle the foundation?

O'NEIL: We had the basement dug and did most of the rest ourselves. I have a friend who is a mason and he set all of my corners, two blocks high, for the concrete-block walls. From there on it was just a matter of filling in between the blocks he'd set and keeping them plumb all the way. My wife helped me in setting the blocks. In fact, she beat me. She set about 90 one day. She only weighs a hundred pounds and the blocks weigh 40 or 50 pounds. Here's a tip for two people laying block on the same job: It's better if one person lays an entire row.

SCHILDT: I was the laborer with my dad's help on the foundation. I had a fellow come in with a bulldozer and dig out the cellar. Unfortunately we hit rock. That was the first place where I should have deviated from my plans, but didn't, and it cost me an extra \$100 in blasting. My foundation footings went in very nicely. We mixed all our own concrete, rented a mixer for \$16 for six months. I did all my own cement work except the laying of the block. A friend of mine built a house and it took him three months to lay the block, doing it alone.

O'NEIL: Mine took approximately two months, for 1800 block.

LINDBLOM: I used a concrete-slab foundation. I rented a bulldozer for the excavating and used it myself. I raised the foundation grade about a foot at the low end for perfect drainage. My only cost was \$10 for using the machinery. After that I put in my own forms and had a cement contractor do the pouring. It took two men one day to pour the entire foundation. I used 24½ yards of ready-mixed concrete in the 24 by 40-foot slab.

O'NEIL: I would have been better off if I had had the basement done by a regular contractor.

LINDBLOM: I used three inches of crushed rock for good drainage and had a waterproofing compound added to the cement to keep the moisture from going through.

Q: How did you waterproof your basement walls?

SCHILDT: Stucco and mastic.

O'NEIL: I had mine done for only \$25.

(Continued to page 278)

SAWING IS EASY WITH THESE TWO FAMOUS "DO-IT-YOURSELF" POWER TOOLS



"ARCO-SAW"

the only circular saw attachment guaranteed to whiz thru 2x4's in one cut or your money back! No need to pay 3 to 5 times as much for saws that do the same work. Accurate, fast adjusting

Depth, Bevel, Rip Gages are foolproof—give your projects professional-looking results. Convert your basement or attic 8-times faster than handsawing—build modern kitchen cabinets, bookcases—and save plenty! Simply attach "ARCO-SAW" to any 1/4" electric drill by tightening strong **Safety-Yoke & Clamp** around drill and run thru heavy lumber. You'll find "ARCO-SAW" with its tough steel gears practically indestructible.

BLADES—5" Safcut, Rip, Crosscut, or Comb... \$1.75

No. 455 "ARCO-SAW" \$12.50 with blade

90-DAY FACTORY GUARANTEE

"ARCO JIG-SAW"

Does work of Jig, Keyhole, Coping, Rip, Band and Hacksaw! EXCLUSIVE "AIR-JET" BLOWS AWAY SAWDUST.

You would expect to pay \$50 or more for a portable jig saw that has the same capacity, cutting speed & precision as "ARCO JIG-SAW." But here, for the first time, is a versatile, rugged saw that attaches in 1 minute to any 1/4" electric drill—eliminates expensive built-in motor—saves you the difference! **Gum**—anchors to cut intricate patterns, circles—no matter how large—in eels—no matter how large—in plywood, wallboard, plastics, metals

No. 401 "ARCO STAND".....\$2.75
G Blades for wood, metals, etc.....\$1.95



No. 500 "ARCO JIG-SAW" \$10.95 with blade.

AT BETTER HARDWARE STORES EVERYWHERE

BUY THE BEST—see your hardware dealer now! If not available, try "ARCO" Tools on our 10-DAY MONEY BACK GUARANTEE. Send us check or M.O. (Postpaid). C.O.D.'s—postage extra.

ARROW METAL PRODUCTS CO. Dept. PM-10, 140 WEST BROADWAY, NEW YORK 13, N. Y.



ELECTRIC WELDER AC or DC 110 Volts

The "Little Marvel" all-metal welder. 5-year written guarantee. Welds 1/8" metal or money back. Repairs tanks, tools, fenders, machine parts, etc. Complete with everything—rods, unit, eye shield, directions.

\$6.45 plus 50c postage. Flame torch accessory for soldering, cutting, brazing \$3.95 complete with carbons, brass rods, flux. Sorry no C.O.D. Buy direct and save.

ESSAY MFG. CO., Dept. 51, Quincy 69, Mass.

\$6.45 Complete

IDEAL LAWNMOWER SHARPENER



BOOST YOUR INCOME

You can earn extra cash with the Model 300 Ideal Lawnmower Sharpener. Used and recommended by leading manufacturers and service shops, the Ideal has everything you need, nothing else to buy. Grinds reel and bed knife, also reconditions. Get started now in this highly profitable business. Write for catalog today.

The Fate-Root-Heath Co. Dept. PM-10, Plymouth, Ohio

DO IT YOURSELF - save up to 50%

READY-TO-ASSEMBLE beautiful solid Ash bedroom furniture. Single dresser shown \$39.95 without mirror, plus shipping. SEND FOR CATALOG... 25 cents

Show-off

Box 333P Jamestown, N. Y.



PUNCH PRESS

1 Ton Power Bench Type Make Your Shop Complete Powerful—Dependable—Economical Easily make your own dies for light stampings, forming, riveting etc. Ideal for production or experimental work. Replaces more expensive presses. Uses 1/2 to 1/2 H.P. motor. Weight 105 lbs. Fully guaranteed. Only \$97.50 less motor. Write for free circular.

ALVA F. ALLEN Dept. PM, Clinton, Missouri

ALSO CHILD'S 2 PASS. MOTOR CAR Write For Free Literature

ESHELMAN HOLDS 1 ADULT

AUTO WITH MOTOR

LOWEST PRICE 70 Miles Per Gal. Gas 25 Miles Per Hour

Eshelman

DEPT. CM-810 109 Light St. Balto 2, Md.

333 N. Michigan Ave. Chicago 1, Ill. 7070 Hollywood Blvd., L. A. 28, Cal.



Write For Free Literature

SWIFT

HAS A HOME...

FOR EVERYONE!

ONE TO FIVE BEDROOMS!

\$1595 to \$3795

BUILD YOUR OWN SWIFT HOME AND SAVE THOUSANDS

MANY MODELS TO CHOOSE FROM THREE ROOF STYLES

NUMEROUS FLOOR PLANS

SEE YOUR LOCAL DEALER TODAY

SWIFT HOMES, INC., ELIZABETH, PA.

*DEALER FRANCHISES AVAILABLE IN MANY EXCLUSIVE TERRITORIES



SEND 25c FOR COLORFUL CATALOGUE

Now You Can Do It Yourself

CONFINE DESTRUCTIVE
COOKING HEAT,
GREASE and STEAM
TO YOUR STOVE

It's the Most Important
Protection You Can Give Your
Expensive Decorations and Furnishings!

Anyone who can use a keyhole saw, hammer and screw-driver can easily install a Vent-A-Hood. Work a miracle in your home! The cooking odors you smell drifting throughout your home are hot, buoyant animal fats or vegetable oils cooling and settling to become a rancid, ruinous film on woodwork, walls and furnishings. Vent-A-Hood consumes Summer's stifling cooking heat and Winter's steamy, greasy cooking vapors before they can touch your home... providing real home comfort and saving money year after year. Vent-A-Hood traps cabbage odors which wall or ceiling fans cannot. Vent-A-Hood is complete with simple-to-follow step-by-step instructions.

Write Today! Money Back Guarantee!

Write for free Cooking Ventilation Folder, order blank and Vent-A-Hood's detailed, no risk, money back guarantee.

Vent-A-Hood

191 PLANTATION ROAD DALLAS, TEXAS

HOME COOKING VENTILATION SPECIALISTS



New "PULL-GEAR" SPEED-REDUCING PULLEY



Provides Correct Speed and
Power to Drill Up to 1 3/8"
with 1/2 H.P. Motor

Amazing new internally geared speed reducer doubles drill press capacity. Greater power, greater efficiency, greater productivity.

Provides the correct speed and power for larger drilling, reaming, tapping and boring on light presses. Easily installed in five minutes. Adaptable to all type machines. Spindle speed range approx. 45 to 3000 RPM. Made in 3 motor shaft sizes: 1/2" — 5/8" — 3/4". Write for literature.

WRITE
FOR
LITERATURE

THE PULL-GEAR CO.

25427 Mound Road
Center Line, Mich.

It would have taken me two or three days and they did it in 15 minutes.

SCHILDT: A number of good waterproof products are available to put on the inside.

O'NEIL: I had a bad experience with my wall that anybody should guard against. It cracked. I think this was due to pressure from the floor joists because I put them in too tight. I had to use a hammer on some.

Q: How did you handle the framing?

O'NEIL: We had a set of plans with the framing all figured out, but decided we wanted the windows in different places. When we put them in we had to change all the studding positions. I'd advise anybody to follow his plans and not make changes like we did.

SCHILDT: Our house is two-story on one side with an exposed basement wall. I had to make sure my windows lined up with the ones below. They worked out fine. When I put the lath up for plastering, everything fit perfectly, very little patchwork. I did deviate from the plans on my room sizes. I made some mistakes when I drew the plans. I had my cellar stairs coming up the middle of the hallway—got a wrong measurement there someplace. I have a slight pitch on the roof, about four inches to the foot. Having my closets back to back and right down the center of the house, I had a perfect place to brace my ridgeboard by putting 2 by 4s straight down. I did not use trusses partly because I wanted to use the attic for storage space. We put in a folding stairway and have only a four-foot clearance in the attic.

LINDBLOM: I used roof trusses and cut all my material for them at one time. I timed myself in putting the trusses together on the floor. I found I could build one in 20 minutes after having the jig set up. I set them up on 16-inch centers.

Q: How about the sidewalls?

LINDBLOM: I built the studding on the concrete slab and raised it up. Worked wonderfully.

SCHILDT: I have a suggestion for home-builders. When you are putting up your studding, nail your sill down first, mark off your 16-inch centers all the way around your house, and lay your top plate right next to the sill. Mark off the same lines. Put an X on one side of the line so you know which side your studs are going to be standing on. Then nail them first to the single plate. Then nail the second plate and stand them up as complete units instead of doing as I started out, putting them in one at a time.

O'NEIL: Another important thing in laying your floor or ceiling joists is to have that crown, or warp, up. I didn't and had a lot of trouble.

(Continued to page 280)

A "Must" Book for Boys of All Ages and
the Greatest Gift Book of All Time!

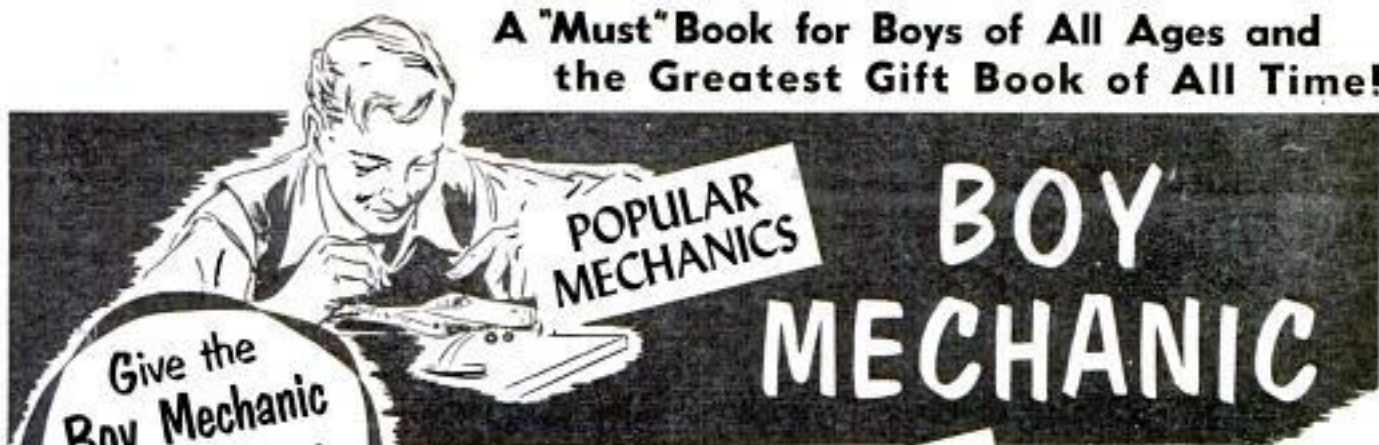

Give the
Boy Mechanic
for Christmas
and other Gift
Occasions

FREE Any Name Stamped
in Gold on Cover

Any name you wish will be stamped in gold on the
cloth bound front cover FREE if you remit with order

NEW!

Fascinating! Educational!

How to Make Things That Work and Go!

This is it, fellows! Here's the exciting book you have been waiting for. Get the brand new Popular Mechanics **BOY MECHANIC** for yourself or be sure you get it soon for a gift. You know it's the fellow who can do things—make things that "work" and "go" who is the kingpin in every school and neighborhood. Enjoy this popularity yourself. Learn what to do—what to make—how to make it—with the **BOY MECHANIC**. Have fun with outdoor projects and gadgets; models of every type; your own scientific experiments and instruments; all kinds of craft work with wood, metals, plastic, etc; easy to make toys for yourself and others.

Something for Every Place, Time and Season

Think of it! More than 500 wonderful ideas you can use, selected by Popular Mechanics editors. Projects for the home workshop; in camp; on land and water and in the air. Projects for summer and winter and in between. More than 1100 pictures and diagrams show you exactly what to do and how to do it. It's a big, fascinating and helpful book that will give you hours and hours of fun and show you how to make so many of the things you have always wanted.

A Grand Big Book!

**Beautifully Bound
in Library Cloth and
Personalized With
Your Name in Gold
on the Cover**



308 Pages

Packed with fascinating pictures and practical how-to-do-it information on outdoor projects, models and model making, spare time crafts, workshop fun, simplified science, toys, etc.

1100 Pictures

Photographs, Drawings, Diagrams, Plans and Construction Details. The most elaborately illustrated "What to Make" book ever printed.

**Rush Coupon
Today!**

Be the first in your neighborhood to get the **BOY MECHANIC** by mailing the coupon today. Only \$2.95 postpaid. And we'll stamp your name (or any other name if a gift) on the cloth bound cover in gold FREE if remittance accompanies order. Be sure to **PRINT** name for gold stamping and mail order today.



Model Airplanes, Railroads,
Ships, in Model Section



Fascinating Tin Craft,
from Indoor Crafts

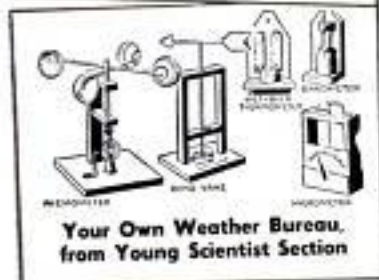

Your Own Weather Bureau,
from Young Scientist Section

**Some of More Than 500
Articles in Boy Mechanic**

Build a Soap Box Derby Racer — Coasting in a Sidewalk Jeep — Aero Driven Ice Boat — Eight Repair Kinks for Your Bicycle — Sea Scout Dinghy — Control Line Flying Model Planes — Model Racing Yacht — Model Railway Small-Space Track Layout — Leathercraft — Tin Can Craft — Useful Articles from Hammered Copper — Jackknife Animal Carving — Easy to Make Hand Puppets — Art With the Typewriter — Dog Quonset Hut — Bird Houses and Cages — Home Laboratory Short Cuts — Your Own Weather Bureau — Toy Electric Motors You Can Make — Fun With Common Gases — 100 Power Microscope — Six-in-One Puzzle — Magnetic Theatre — Turkey Hunt Dart Game. And hundreds of others.

**POPULAR MECHANICS PRESS, Dept. 111
200 E. Ontario Street, Chicago 11, Ill.**

Send me at once _____ copies of the **BOY MECHANIC** at \$2.95 each.

- Remittance enclosed. Stamp name in gold and send postpaid.
- Send COD. I will pay postman plus delivery charges.

Name _____

Address _____

City _____ State _____

Print name on this line for gold stamping. Use margin for additional names.



Get Good Performance the Way Big Fleets Do...

Consolidated Freightways Uses Federal-Mogul Engine Bearings

Good engine performance is vital to the big truck fleets who move the nation's merchandise on its way to market.

Take a tip from the big fleets! For example, Consolidated Freightways, with headquarters in Portland, Oregon. They make wide use, in many of their engine applications, of Federal-Mogul oil-control bearings.

Federal-Mogul engine bearings can restore dependable engine performance for you, in your driving for business or pleasure. They have led in the replacement field for 30 years . . . because of quality! Ask your mechanic! FEDERAL-MOGUL SERVICE, Division Federal-Mogul Corporation, Detroit 13, Michigan.

for New Power . . .

FEDERAL-MOGUL

Oil-Control Bearings

BEARING
MANUFACTURERS
TO THE
AUTOMOTIVE
INDUSTRY
SINCE 1899



Q: Any pointers on windows?

O'NEIL: I got mine pre-cut from a mail-order house.

SCHILDT: I made my awning-type windows at night in my dad's cellar.

LINDBLOM: I ordered my windows and door frames. Had a man come in and measure them. I put them in myself. My frames cost me \$150. Windows were another \$100.

Q: Did you lay up your own chimneys and fireplaces?

O'NEIL: I hired the dining-room fireplace built. For the living-room fireplace, I put the base in and ran the hearth two feet above the floor. Not knowing anything about brick work, I had a mason put in the firebox up through the throat to where the chimney started. I filled in around the outside with brick and put the chimney in all by myself.

SCHILDT: I also have two fireplaces. I put one in the basement myself, a Heatilator type. I had a mason do the one upstairs, also the chimney.

LINDBLOM: I had my fireplace installed by a contractor. It cost me \$350.

Q: What kind of siding did you use?

LINDBLOM: First, I inquired about the cost of redwood and found it would run me \$225 per thousand feet. This siding is cut diagonally out of a 2 by 12-inch piece of lumber. You get two pieces out of one. Then it is laid for overlap. That's what we used—redwood. A thousand feet did the house.

SCHILDT: I used a striated plywood that comes in sheets 4 by 12 feet. It is very reasonable in cost. Incidentally, when the lumberyard delivers any kind of lumber, lay it flat so it doesn't warp.

O'NEIL: Mr. Lindblom, did you stain your siding, or use some sort of protective coating?

LINDBLOM: I have two coats of boiled linseed oil on it, which I applied over a period of time. I gave it a good chance to dry in and six months later put on a coat of bear oil. It's like a varnish.

Q: How did you handle the insulation?

O'NEIL: We are using the batting-type insulation in the house, with the pellet type in the ceiling between the joists.

SCHILDT: I used four-inch batting in my walls, and loose rock wool in the attic.

LINDBLOM: I used the pellet type in the attic. It's easy to handle.

Q: How did you finish the interior walls?

LINDBLOM: I used plaster with the exception of where I have a birch-faced plywood wall between the kitchen and the living room.

SCHILDT: I had my house plastered. It cost \$2.30 a square yard.

LINDBLOM: How much for the job?

(Continued to page 346)



new, quiet **Evinrudes!** *smooth as sailing...*
horsepower with a **hush!**

A RIDE you will always remember—your first fabulous ride with a new *Whispering Power* Evinrude! So quiet . . . so blissfully quiet you hear the swish of the bow wave above the motor's hum!

But *quiet* is not all. You quickly sense that this ride is different from any before. There's a luxurious feeling of utter smoothness. Motor vibration and "boat shake" are magically gone! The wind in your face, the streaming wake, the whisking shoreline, all tell you you're going fast. But your ride is smooth as the

glide of a sailboat in a kindly breeze.

You will know that here, beyond question, is the *future* in boating fun . . . a new standard of performance that plainly charts outboard development for years to come. But all the wonderful pleasure of it can be yours *right now!*

SEE YOUR EVINRUDE DEALER—look for his name in the yellow pages of your phone book under "Outboard Motors." Choose from a complete range of 1955 models—3, 7½, 15 and 25 horsepower. The 25 HP Big Twin *Aquasonic* is offered in

both electric starting and standard models. Prices are no higher than you'd pay for ordinary motors. Time payments available. Your old motor brings top trade-in right now! For free catalog, write **EVINRUDE MOTORS**, Division of Outboard, Marine & Manufacturing Company, 4496 North 27th Street, Milwaukee 16, Wisconsin.

In Canada: Mfd. by Evinrude Motors, Peterborough.

Evinrude
quiet *Outboard Motors*



1

Replace thermostat every year for maximum heater efficiency and better cooling system performance. Quality built original equipment replacement. Rust-proof. Easy to install. Either Alcohol type or Permanent Anti-freeze type for all popular cars from.....\$1.28 to \$2.10



2

Wizard fuel pumps, guaranteed for long, dependable service. Original equipment replacement. Diecast body; precision machined surfaces and parts; fully tested for correct pressure. Diaphragm of extra high quality for longer life, top performance. For all popular cars (887291)\$1.75



3

"Minit-On" Tire Chains—so revolutionary you can put them on in just *one* minute. Install anywhere—in snow, on ice, or on a hill. Not "snap-ons", but complete, patented chains with adjusters. Tough, wear-resisting links. Plastic coat sleeve protectors included. Pair from \$13.95

New Power...New Beauty...

New Safety For Your Car At **Western Auto**

STORES AND ASSOCIATE STORES

NOTE: Western Auto Associate Dealers own their stores and set their own prices, terms and conditions. Prices may vary due to differences in local conditions. (PM 134)



4

Don't be stranded by a worn-out fan belt. Replace now with a Western Auto extra-quality fan belt. Inner core of endless cable cords. Tough rubber cushion reduces heat, assures long life, cooler-running performance. Can't warp, slip, or stretch. Guaranteed fit. (789105).....98¢



5

Easy to change tires at night, spot street signs, house numbers with this all-purpose spotlight. Plugs into lighter socket, or dash socket which is included. Beautiful die-cast chrome-trimmed handle and rim with blue enamel back. On-off switch, GE bulb, 10' cord. 6-volt. (216116)\$5.19

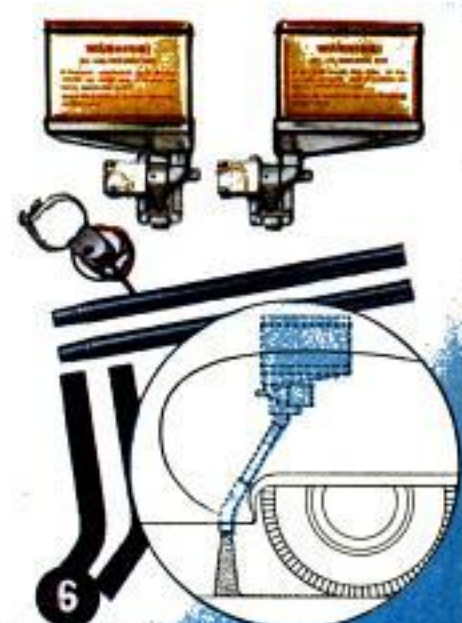

6

"Grip King" Electric Road Sander mounts in car trunk. At touch of electronic control switch on the steering post, instantly discharges grit in front of rear wheels for non-slip starting, stopping on icy hills, packed snow, slick curves. Easy to install. Less grit. \$23.95 Non-freezing grit. 50 lbs. \$1.59

FREE: Mail post card today for folder explaining how to get more horsepower from your car. Write Western Auto, Dept. 2007, 2107 Grand, Kansas City, Mo.

Copyrighted material

POPULAR MECHANICS DO-IT-YOURSELF WEEK SPECIAL SECTION

As the world's accepted source of do-it-yourself ideas for over a half century, it is appropriate for Popular Mechanics to join the many retail hardware and lumber dealers who are celebrating October 3rd through 9th as "Do It Yourself Week." Accordingly, Popular Mechanics presents this Special Section of do-it-yourself hints and projects plus the advertisements of many famous manufacturers of do-it-yourself tools and materials.

Do-It-Yourself . . .

"DO-IT-YOURSELF" is not a fad, as is sometimes suggested. Rather, it is the American way of life asserting itself, and actually stems from the founding days of this nation, when rich and poor alike were proud to do things for themselves.

It was not until after World War II that it became a byword and was recognized for what it is—a multibillion-dollar industry touching virtually every home in the land.

Continually rising tax and real-estate costs and labor shortages were contributing factors. The returning GI and his bride, seeking a home of their own, found their slender purse often insufficient to complete their dream house. Having purchased the basic structure, they had to maintain it themselves and do their own job of expanding, such as adding rooms in the attic or building a garage.

Businesses that for years catered to the professional artisan, suddenly discovered a great new market, and homeowners who had scarcely dared to touch hammer to nails, unexpectedly found they could paper their own walls or tile bathrooms with

products developed especially by these manufacturers for do-it-yourselfers.

In addition to saving money, men and women everywhere suddenly discovered they were having fun. They found a new friend and adviser in the friendly, helpful, hardware and lumber dealer.

For more than a half century, *Popular Mechanics*, the original do-it-yourself magazine, has published thousands of articles showing its readers how to do and make things themselves. It has served as an authority for the professional. It has helped the amateur approach professional status. It has offered advice and counsel to the hobbyist and home craftsman, who is now engulfed in the inclusive title of "Do-It-Yourself."

This month hardware stores and lumberyards are promoting the do-it-yourself movement with an organized campaign. We congratulate them and suggest that our do-it-yourself readers, and those who have not yet experienced the pleasure and economy of doing things themselves, consult these merchants.

New
Porter-Cable
Homemaster
1/4" Drill

Now, just in time for Christmas, a new Porter-Cable 1/4" drill . . . plus a complete 12 piece drill accessory set . . . all for the special introductory price of only \$29.95.

Show this ad to your wife. Or buy one as a gift for yourself. You can't miss. New Homemaster Drill stands way out in front both in features and value: Gear chuck, trigger switch, ball bearing on spindle, polished finish, 2 amp. motor. Kit includes rough sanding and finish sanding discs, polisher-buffer, back-up pad and attachment, three twist drills, 1/4", 3/8", 1/2", polished metal carrying case, etc. See your dealer or drop postcard for name of nearest Porter-Cable Homemaster Store. Porter-Cable Machine Co., 2450 N. Salina St., Syracuse 8, N. Y.

Plus
12 Piece Accessory Kit
in Special
INTRODUCTORY OFFER
Special
Combination
Price **29.95**
Drill Alone **24.95**
12 piece kit
included in
introductory
offer, . . . **ONLY 5.00**

POPULAR MECHANICS

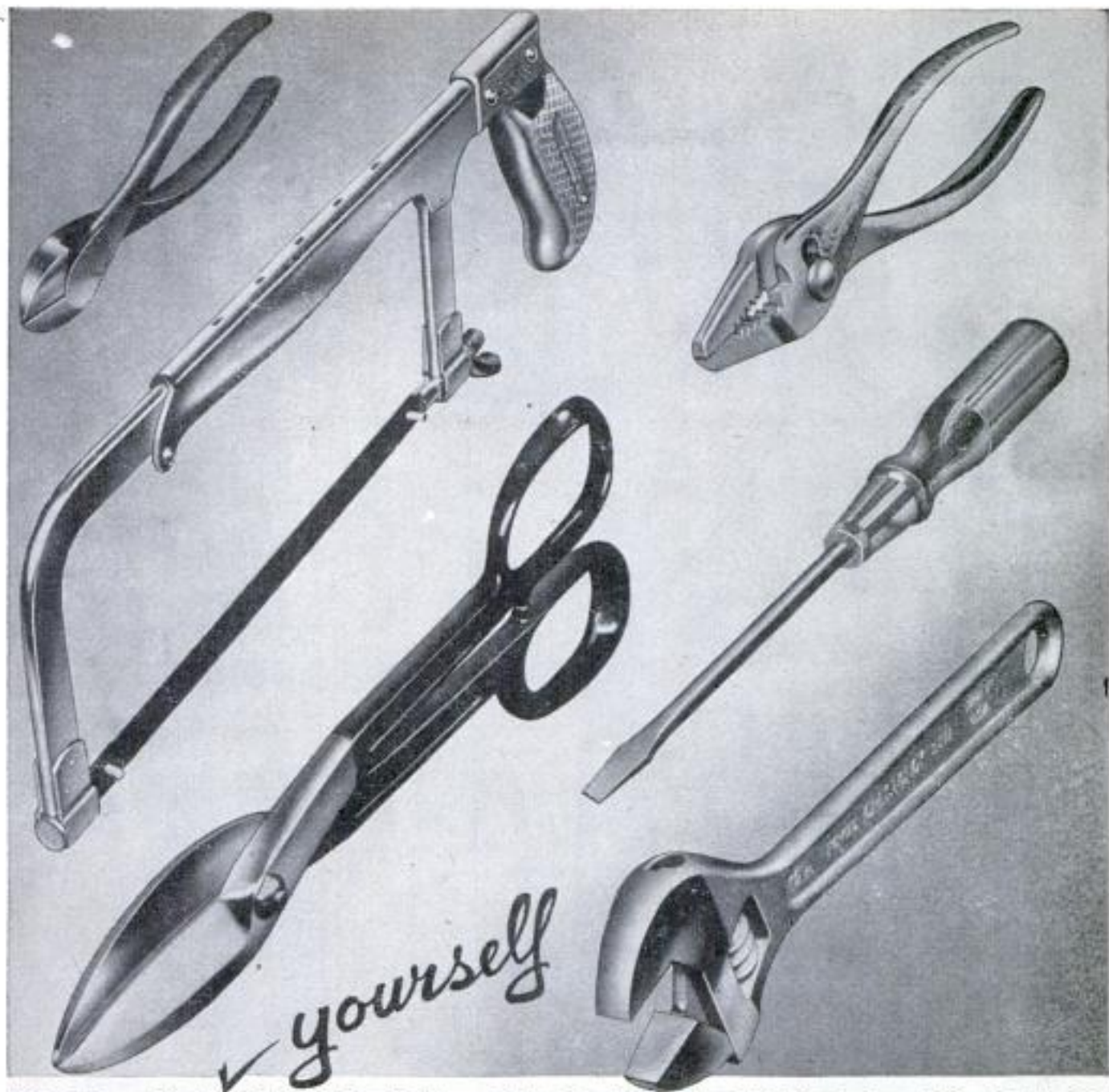

DO IT WITH CRESCENT TOOLS

Good Tools help get the job done quicker and better whether in the hands of amateur or professional mechanic. Crescent has been making nothing but fine Tools for nearly half a century. For well-balanced, easy-working tools that last longer and perform better, insist on CRESCENT or CRESTOLOY.

Sold by Hardware Dealers and Industrial Distributors everywhere.

CRESCENT TOOLS

Give Wings to Work

*Sign of the Artisan
Symbol of Excellence*

®

Crescent is our trade-mark, registered in the United States and abroad, for wrenches and other tools. Sold by leading distributors and retailers everywhere and made only by
CRESCENT TOOL COMPANY, JAMESTOWN, NEW YORK

for the first time
a modern power tool
 as simple to run as a
modern appliance

It's

TAKE IT



- ★ **NO MOTOR TO BUY!**
- ★ **NO V-BELTS TO BUY!**
- ★ **NO PULLEYS TO BUY!**
- ★ **NO POWER LOSS!**

What rugged construction!

As simple to run as a toaster!

Can be kept in a closet!

Look at the big Control Panel that's so easy to see!

An Amazing Value at Only . . .

\$99⁵⁰

OTHER FAMOUS SHOPMASTER TOOLS

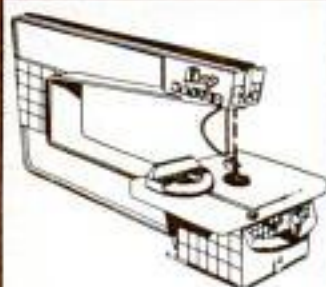

20" JIG SAW Built-in motor. Blade turns to rip. **\$45.95**



12" DRILL PRESS BENCH model Jacobs Chucks. **\$52.50**



10" TILTING TABLE BAND SAW Aluminum alloy. **\$52.50**



6" JOINTER-PLANER Cuts 1/2" deep and 6" wide. **\$89.95**

Complete!

HOME JUST PLUG IT IN!

IT'S THE REVOLUTIONARY NEW

Shopmaster

FLOOR MODEL 8" CIRCLE SAW with BUILT-IN-MOTOR, table extensions

Now for the first time a power tool that is as simple to run as a modern appliance. You just plug it in! No motors to buy or mount! No V-belts or pulleys to worry about. Just bring it home, and plug it in! Now, the most important tool for your home workshop is also the easiest to operate. Shopmaster's handy floor model 8 inch tilting arbor Circle Saw features a

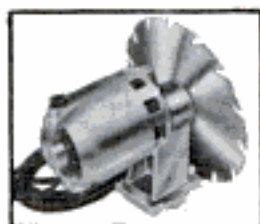

BUILT-IN-MOTOR

one-piece all-metal stand; has a specially-built nationally famous motor that develops up to $\frac{3}{4}$ horse power torque—direct drive motor . . . Operates with no power loss! Note the newly designed master view indicator with the finger-tip control. Blade cuts $2\frac{1}{2}$ " depth and tilts to a full 45 degrees. Table size with extensions is 16"x30". Comes complete with stand, saw, built-in motor, cord, mitre gauge, stop rods, rip fence, 8" Roc-edge blade, side extensions and plastic guard—nothing else to buy! All for only \$99.50.

MAIL TODAY



COMBINATION BELT AND DISC SANDER \$55.50

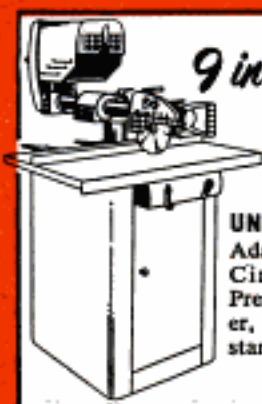

9 in one tool

UNIVERSAL TOOL
Adapts quickly to Circle Saw, Drill Press, Sander, Shaper, Router. Includes stand. **\$267.50**



Shopmaster Rm. 10P
1214 S. 3rd St., Minneapolis, Minn.

Please send me complete information about the New Shopmaster Circle Saw.

Name _____
Address _____
City _____ State _____

Aluminum-Veneered PIPE RACK

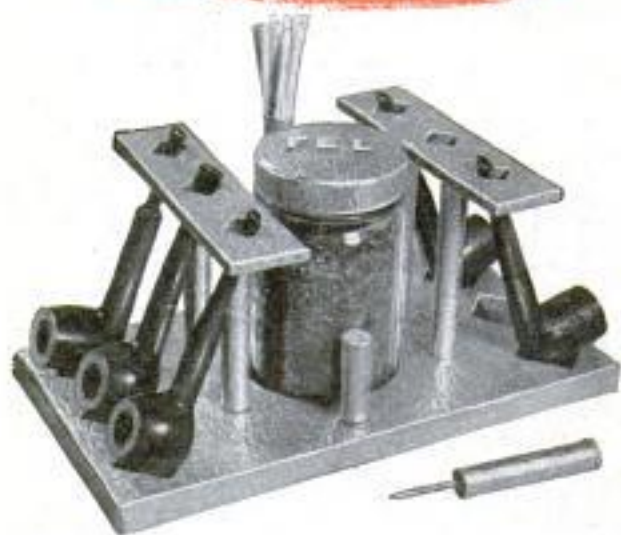

THIS ATTRACTIVE pipe-rack-and-humidor set is covered with embossed aluminum and includes a holder for pipe cleaners and a pick for removing dozzle. The wooden base and upper brackets are cut and drilled to the dimensions given in the detail, then covered with sheet aluminum which is

folded under and bradded to the bottom. Felt is cemented to the bottom of the base. The aluminum-covered $\frac{1}{2}$ -in. dowels which support the brackets were $2\frac{3}{4}$ in. long on the original rack. The dozzle pick is a sharpened nail driven into a dowel. The pick holder is a short length of dowel glued to the base. An aluminum tube, $\frac{1}{2}$ in. in diameter, holds the pipe cleaners. The humidor is a glass mayonnaise jar.

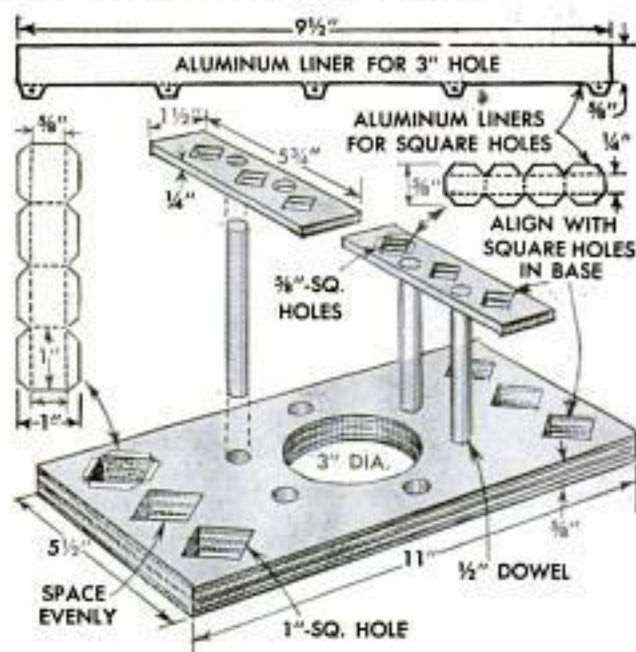

NEW Porter-Cable Homemaster 3" Belt Sander

Now the EASY WAY to Sand Do-It-Yourself Jobs!

Multi-use tool makes an expert
out of an amateur. A wonderful
Christmas gift for only

59.⁵⁰

● Specially designed by experts in the belt-sander field, the Homemaster brings to the Do-It-Yourself user all the know-how and exacting standards of Porter-Cable manufacture . . . at the lowest price ever offered on a tool of this quality. Full 3" width; a faster, easier-to-use tool that's almost fool proof in the hands of the non-professional. Sands, finishes with smooth, straight-grain cuts. No swirls, no gouges. Belts for wood, compositions, metal, ceramics, glass. Excellent for vertical and overhead work.

● See your dealer or drop postcard for name of nearest Homemaster retail store. Porter-Cable Machine Co., 2870 N. Salina St., Syracuse 8, N. Y.



- * Takes off paint, re-surfaces furniture.
- * Fits windows, screens, doors.
- * Removes stock easily as a plane.



Here's a tape that will hold it!

NEW Behr-cat® STRAP TAPE



A 180 lb. pull can't break this super-strong, glass-fibre reinforced tape. Proven by industry, it's now available for household use for countless taping jobs where strength is a must. It's pressure sensitive for quick, sure stick, too. Ask your Hardware Dealer for BEHR-CAT® Strap Tape.



Strong BEHR-CAT Strap Tape stops tools from rattling in car trunk.



Safe arrival is assured when Strap Tape is used to seal packages.



GET FINER FINISHES WITH BEHR-MANNING® GARNET PAPER

The professional cabinet makers' favorite for hand sanding. Outlasts ordinary sandpaper and produces superior finishes too. Send 10c for "SANDPAPER — How to Choose and Use."



KEEP TOOL EDGES SHARP WITH AN INDIA® BENCH STONE

Pre-filled with oil to resist clogging and produce factory-sharp edges in quick time. Send 10c for the famous "How to Sharpen" Book. Behr-Manning, Troy, N. Y., Dept. PM-10.



BEHR-MANNING
CORPORATION
division of NORTON Company

▲ COATED ABRASIVES
▲ SHARPENING STONES
▲ PRESSURE-SENSITIVE TAPES

LAMINATED NUT BOWL

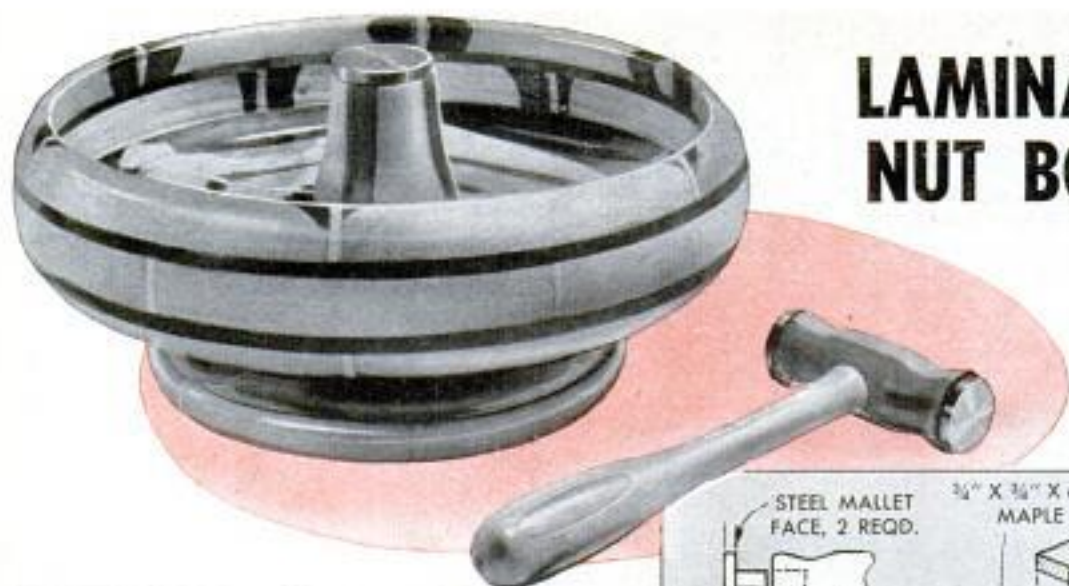

FUNCTIONAL and attractive, this nut bowl is turned from stock laminated of alternating dark and light woods. The stock is cut into 60-deg. segments and 18 pieces are spaced with $\frac{1}{8}$ -in. strips to form three hexagons. The 6 $\frac{1}{2}$ -in.-dia. base is cut from the center of the first hexagon. Black-walnut strips and the anvil, shaped as indicated, complete the assembly. The mallet is built-up as indicated in the detail. Caps turned from 1-in.-dia. steel are fitted on the mallet and anvil.

(Continued to page 290)

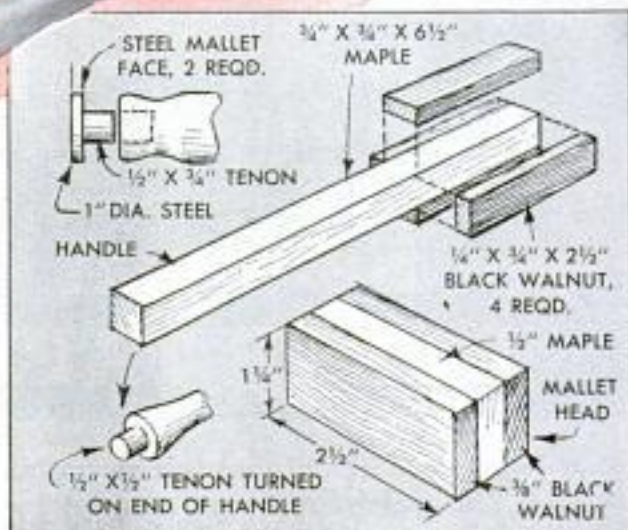

Buy **EVANS** for
EXTRAS
in 6, 8, 10 and New 12 Foot
"WHITE-TAPES"



FREE WITH EVERY TAPE
— this sparkling crystal
Tenite utility case.

This is the BUY for your money — the original, reasonably priced "White-Tape" by EVANS. Your measuring tape dollar goes further! Chrome plated, sturdy case. Snow-white Bonderized steel blades with jet markings, easy to read, last longer. Velvet push-pull action. Instant change replacement blades available. 12-foot size, made *only* by EVANS, has convenient new blade markings in feet and inches as well as regulation inches.

Evans & CO. 410 Trumbull St., Elizabeth, N. J.

EVANS
L-O-N-G "WHITE-TAPES"
25-50-75-100 Ft. Lengths. Sensibly priced from \$3.49. In transparent utility box. Leather grained vinyl cover. Hook ring attachment no extra charge.
Sold Only Through Retailers

EVANS, THE LARGEST PRODUCERS OF STEEL TAPES WORLD-OVER

Compare the New **SKIL** Saw Value with any other...

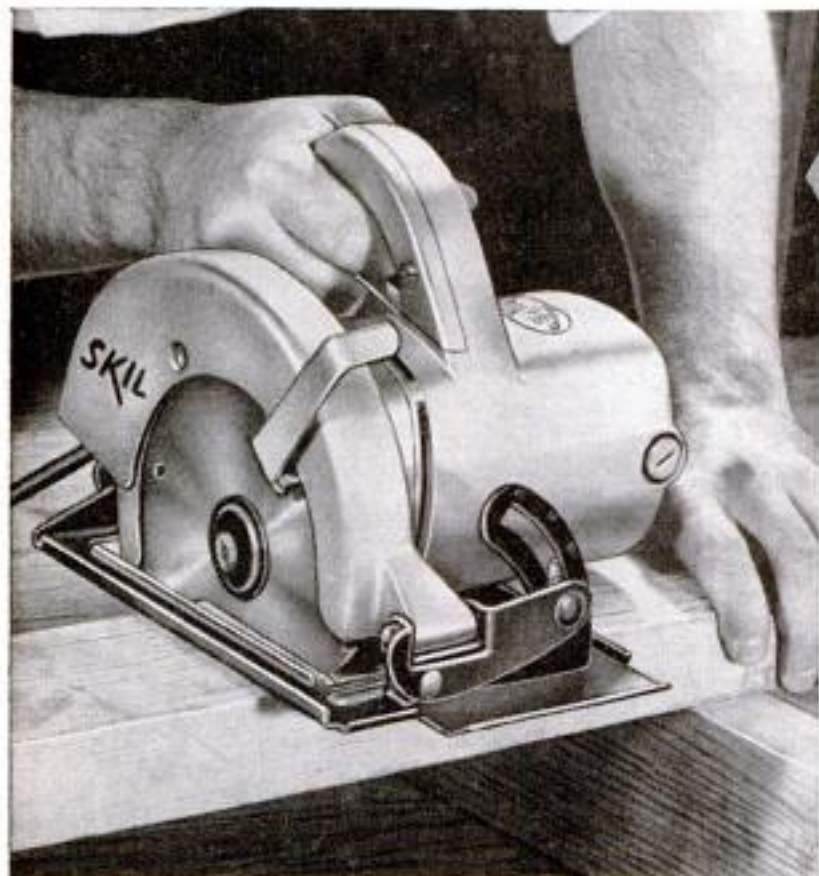

**Only \$39.95 more . . . Converts
SKIL Saw to all-around combination tool**

It's another SKIL "scoop"!

This sturdy SKIL table makes your portable SKIL Saw an accurate, tilting arbor bench saw. Combination meets all sawing needs . . . Portable saw for building or remodeling jobs—plus a bench saw for precision furniture or cabinet work. SKIL Saw Table Combination, only \$89.45.

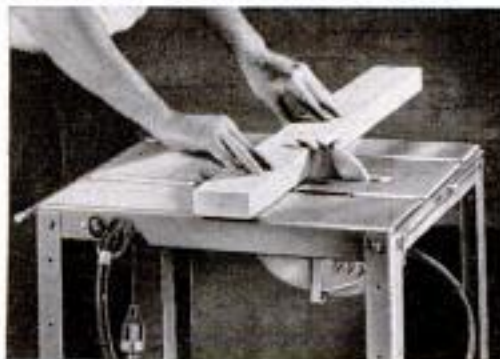

SKIL Home Shop 1/4" Drill
\$24.95 with hex-key chuck
\$26.95 with geared chuck



SKIL Home Shop Bell
Sander 2 1/4" . . . \$79.50



SKIL Home Shop 6"
Sander-Polisher . . . \$43.95

Made only by SKIL Corporation, formerly SKILSAW, Inc., 5033 Elston Ave., Chicago 30, Ill. • In Canada: SKILTOOLS, Ltd., Toronto 9 • Factory Branches in All Leading Cities

at only
\$49⁵⁰

Here's why it's your best buy

For building, remodeling, repairing, or just making things, the new SKIL Saw is designed for you! Only SKIL "know how" could produce this value leader. From blade to handle it's everything that has made SKIL the outstanding name in portable saws.

That's why we say, "Compare the new SKIL Saw Value—with any other, at any price—before you spend a cent!" Compare the features, the balance, the workmanship, sturdiness, power and versatility! Then remember—that the name "SKIL" on any power tool means it's the best money can buy. Only SKIL—the leader—can dare to ask you to compare!

**Compare these Features!
No other saw at this price
can match them!**

Oversize Motor . . . Ball and Anti-Friction Bearings . . . Built-In-Bevel and Depth Adjustment . . . Telescopic Safety Guard . . . Trigger-Type Switch . . . Sturdy, Die Cast Aluminum Housing . . . and many other SKIL-made "firsts."

SKIL
HOME SHOP TOOLS

SKIL Home Shop and Builder's Saws available in 6", 7 1/4", 8 1/4" blade sizes. There are more than 22 SKIL Home Shop Tools to speed work, save time and money for home-owners.

MORE SANDING AREA

than any sander in
its price class

25 square
inches



only **2 5/16"** high...
fits under tight places

LOWEST SANDER DESIGN



The Newest Power Sander and Polisher on the Market

As efficient as any rotating motor-driven sander, plus these quality features: straight-line action, no bucking, sands *with* the grain and goes all the way into corners; powerful 60 cycle reciprocating motor gives 14,400 strokes per minute; exclusive insulation gives smooth, quiet operation; push-button control; 8 foot cord.

Weller

SANDERS

816 Packer Street
Easton, Pa.

AVAILABLE AT HARDWARE STORES

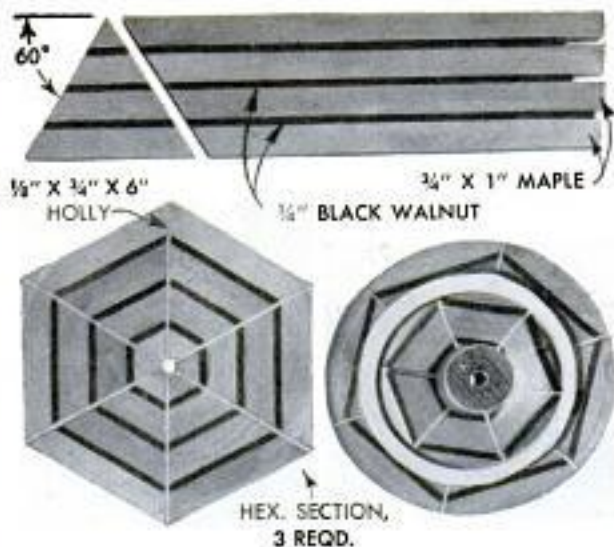

Above, stock from which bowl is assembled and turned is laminated from black walnut, maple and strips of holly. Below, exploded drawing shows relation of various parts and the method of assembly

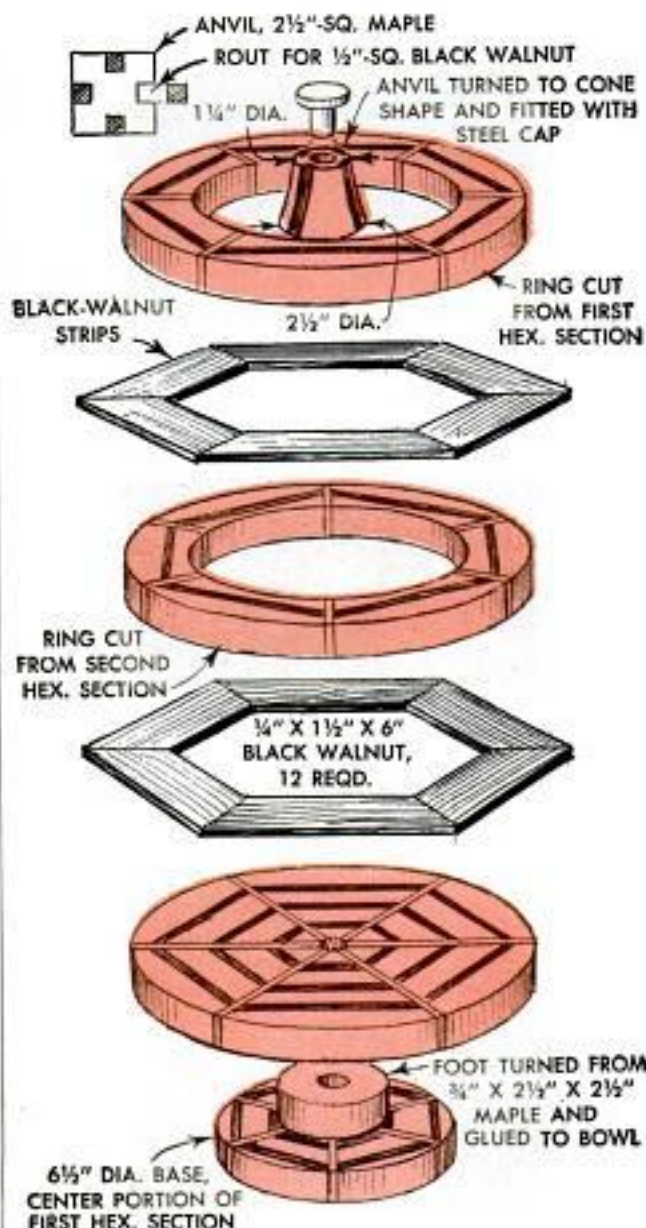

POPULAR MECHANICS

The CHRISTMAS GIFT

that has everything any
homecraftsman or
hobbyist needs

FOR SCORES OF
MONEY-SAVING
JOBS

Perfect gift to give or receive . . .
useful all year 'round. Each kit includes:

- Weller 8250A Soldering Gun—
250 watts
- Famous Kester Solder—general
purpose spool
- Soldering Tip—for all kinds of
soldering
- Smoothing Tip—for mending
and sealing
- Cutting Tip—for plastic tile, etc.
- Wrench—for tip interchange
- Instruction Booklets—handy
soldering and homecraft hints
- Metal Case—for storage and carrying

Nothing else to buy for soldering, sealing, cutting, mending,
joining and smoothing. Makes professional results easy.

NEW WELLER GUNS AND KITS ARE AVAILABLE AT HARDWARE DEALERS

Junior SOLDERING GUN

- New, Compact Design
- Heats in 5 Seconds
- Over 100 Watts
- Trigger Switch Control
- Dual Spotlights

The ideal homecrafters' soldering tool.
No other soldering gun or iron offers the
professional quality, practical features and
low price of the Weller JUNIOR.

Weller

THE FINEST TOOLS FOR THE FINEST CRAFTSMEN
ELECTRIC CORPORATION
816 Packer St., Easton, Pa.

SOLDERING GUNS • SOLDERING KITS • POWER SANDERS

OCTOBER 1954

291

Copyrighted material

only \$14.95

MODEL 8250AK

MODEL
8100

\$7.95

Build your own FIREPLACE INDOOR - OUTDOOR

FREE Booklet shows how



Booklet gives Complete instructions.

- Foundation
- Steel heat-circulating form
- Cold and warm air ducts
- Mantel or decorative front

Fireplace form set on foundation includes firebox, damper, down draft shelf and smoke dome.



Brick, stone or cement block can be used around the form.



Save time, money and materials with PRICE steel fireplace forms.

Build this outdoor fireplace in ONE DAY!

• Use inexpensive concrete blocks with the Fyro-Grill steel form and complete the job in a day. Includes grill, grate, draft control. Removable for winter storage. \$19.95 at Buffalo.

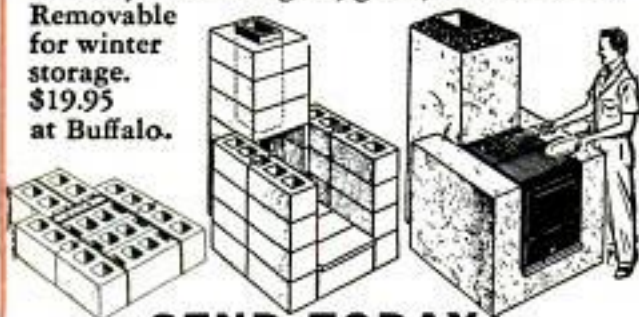

SEND TODAY!

Please send —

- Directions for building heat-circulating fireplace, free.
- Book "100 Fireplace Ideas". Pocket size book, free.
- Larger book, 8½ x 11, beautifully illustrated, 25c.
- Build outdoor fireplace in 1 day. Also, 10 beautiful designs, free.

Name

Street

City

PRICE FORMS AVAILABLE FROM YOUR DEALER

PRICE FIREPLACE HEATER & TANK CORP.
204 W. Austin Street, Buffalo 7, New York

Hints for Using ELECTRIC HANDSAWS

PORTABLE ELECTRIC SAWS, when correctly operated, are versatile timesaving tools that can be used to make an infinite variety of cuts. Whenever possible, the saw should be used so the wide side of the base-



plate remains on solid wood, as in the upper drawing. The weight of the saw is supported and the blade is kept from binding. As shown in the center drawing, pocket cuts are made by pivoting the saw on the front edge of the baseplate. With

the blade set to cut to its maximum depth, the guard is held back and the saw is lowered until it cuts through the wood. It is pulled back a short distance to the nearest corner, then pushed forward as when ripping or crosscutting. **Caution:**



When operating the handsaw with the guard held back, as in pocket cutting, be extremely careful of the exposed blade. Notches are made by setting the saw blade to the desired depth and making a cut at each end of the notch. Then make

two or more cuts in between, as shown below. The waste is removed with a wood chisel and the bottom of the notch is smoothed with a wood rasp and file. Keep the saw blade sharp and properly set.

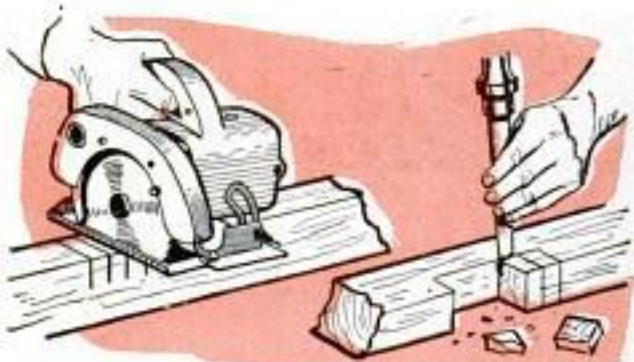

POPULAR MECHANICS

it's easy to decorate with



EXTERIOR



WALLS



FLOORS



WOODWORK



ENAMELING

For a sure, quick, easy enameling job on furniture, woodwork, toys, use Lucas LUCO-KWIK, an alkyd decorative enamel of the highest quality. Dries fast to a porcelain-like finish that's washable.

Send for FREE 40 page booklet
"HOW TO PAINT IT YOURSELF"



JOHN LUCAS & CO., INC. • PHILADELPHIA 3, PA.



Make Every Week
"Do-It-Yourself Week"
with a Black & Decker
1/4-inch Drill!

The world's most popular homeowner's Drill! Bores holes up to 1/4" diameter in steel, 1/2" in wood. Drives Hole Saws up to 1 1/8" diam. in any material a hacksaw will cut. Powered by B&D-built universal motor, it drives accessories to grind, buff, polish, sharpen, wire brush, drive screws. Perfect for hobby work and 1,001 home repairs. Only \$24.95.

THE BLACK & DECKER MFG. CO.
Dept. H10M, Towson 4, Md.

FOR HOME, SHOP, FARM AND INDUSTRY



Black & Decker
PORTABLE ELECTRIC TOOLS



For nearest dealer, look under "Tools-Electric"

Weatherstrip with your fingertip

THE EASY

Mortite WAY!



ELIMINATE UNHEALTHY, fuel-wasting drafts—Mortite your windows *now!* Weather-proofs a window *in seconds* at so little cost! Self-adheres—no tacks or tools—just press in place!



SOFT, ROPE-LIKE STRANDS. ($\frac{1}{4}$ " diameter), unroll like ribbon, mould into place like modeling clay. Use inside or out—no need to go out in cold to apply. Won't crack, chip or peel. Use over and over—in Spring, hold one end, pull right off. 1,001 other uses! Ideal as gasket, caulker, base for flower stems. Perfect plugger-upper for variety of uses in, around home all year long!



29¢ • 98¢ • \$1.25

**KEEP
Mortite
HANDY**

Available At All Leading Stores.
Send For Your **FREE Circular** Showing Mortite Uses In, Around Home!

**JW Mortell
COMPANY**

Serving The Home and Industry Since 1895

522 Burch St.

KANKAKEE, ILL.

Handy Stand for FLEXIBLE SHAFT

By Dick Hutchinson

THIS EASILY MADE flexible-shaft stand brings the shaft, motor and accessories right to the work, eliminating the need for hanging the motor from a nail and carrying an extra box of grinders and cutters. The base of the stand is made of $1\frac{3}{8}$ -in. pine, covered top and bottom with $\frac{1}{4}$ -in. plywood. The pine center of the base is cut out for a small-parts drawer and also for a $1\frac{1}{2}$ -in.-sq. standard. The plywood top also is cut out for the standard. The drawer consists of a rabbeted front of $\frac{1}{2}$ -in. stock and $\frac{1}{4}$ -in. sides and back. These are nailed and glued to a $\frac{1}{2}$ -in. bottom panel. The standard is 19 in. high and glued in the hole in the base, two screw hooks being used to hang the motor and shaft.

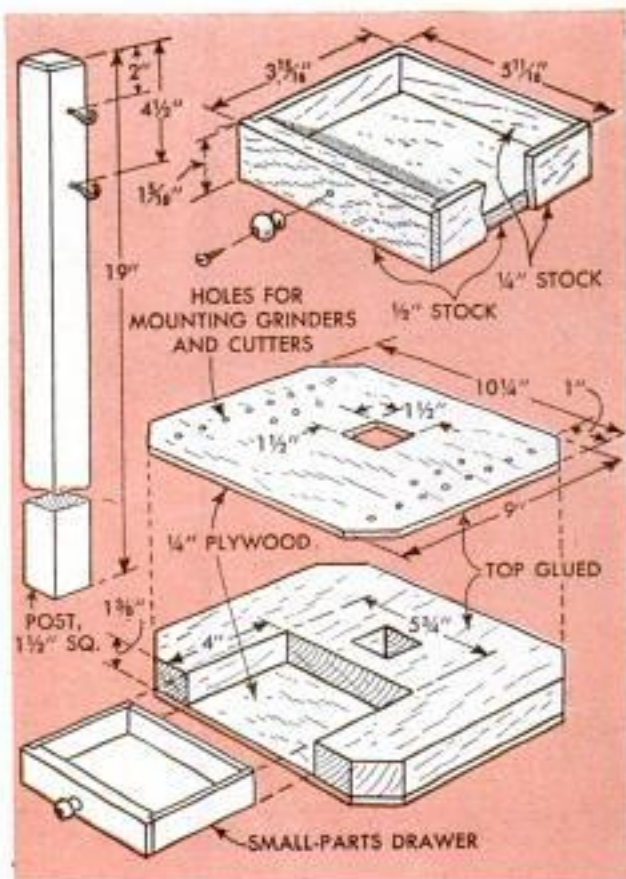

POPULAR MECHANICS

Four types of Temlok insulation board and how to use them

It's easy to add extra living space to your home with Armstrong's line of Temlok insulating fiberboards. For interior use, there's Perforated Temlok Tile, an economical, sound-absorbing ceiling material; Temlok



- 1. TEMLOK PLANK** is a sturdy wood-fiber building material that can help you turn unused space into a cheerful room in just a few days. The special Lok-Bevel joint simplifies installation, assures a correct fit for each plank. Factory painted in a random-colored "Suntan Blend," Temlok Plank comes 8", 12", and 16" wide and 8' and 12' long.



- 3. PERFORATED TEMLOK TILE** is a noise-absorbing ceiling material that can add comfort and quiet to busy kitchens, playrooms, shops, and utility rooms. Installed over furring strips, Temlok Tile has a Lok-Bevel joint that hides nails and staples. Pre-painted tiles, plain or perforated, are 12" x 12" or 16" x 16".

Plank, a random-colored wall finish; and Temlok Board, in large, easy-to-handle sheets for ceilings, walls, and partitions. Temlok Sheathing, used on the outside walls, adds valuable strength and insulation.



- 2. TEMLOK BOARD** comes in large sheets that cover walls, ceilings, and partitions quickly. These big boards mean fast installation because they can be facenailed in place over studs or wood furring strips. Temlok's insulating value keeps heat inside in winter, outside in summer. Pre-painted in Light Ivory. Sizes: 1/2" and 3/8" thick, 4' wide and up to 12' long.



- 4. TEMLOK SHEATHING** nailed to the framework of an enclosed porch or addition adds extra strength and insulation. This sturdy building material is impregnated with asphalt and has a water repellent "Rain Shield" finish to keep your home weathertight all year round. Sizes: 2' x 8', 4' x 8', 4' x 9'.

For full details on Armstrong's Temlok see your lumber or building materials dealer. For your free copy of the booklet, "New Ways to Remodel Your Home," write Armstrong Cork Company, 3710 Watch Avenue, Lancaster, Pennsylvania.



ARMSTRONG'S TEMLOK®

M-67® Monowall®

Cushiontone®

Insulating Wool

Hardboards

Counter-top Cement

News About Glues

FOR "DO-IT-YOURSELFERS"

FROM UNITED STATES PLYWOOD CORPORATION
World's Largest Plywood Organization

NOW THERE'S A WIZARD WITH WOOD FOR EVERY GLUING JOB

New! Amazing Cement Glues Without Clamps.

Weldwood CONTACT CEMENT

A revolutionary new concept in gluing. *First* it dries, *then* you make the bond. And the bond is made instantly, permanently, on contact. No clamps, no presses, no nails. It's a wonderful new tool for do-it-yourselfers. 25¢, 35¢, 60¢ and larger sizes.

3 BIG USES

1. For applying plastic laminates like Micarta or Formica to counters, tables, etc.
2. For applying plywood wall panels without nails (no unsightly nail holes — no puttying).



LOOK FOR THE WELDWOOD NAME ON THE YELLOW AND BLACK LABEL!

3. For making or mending things made of wood, metal (including aluminum), cloth, felt, paper—1001 uses around home, shop, garage.

America's fastest selling wood glue

Weldwood® Plastic Resin GLUE



Makes joints actually stronger than the wood itself. Highly water-resistant, stain-free, rot-proof. First choice of amateur and professional restorers, cabinet makers, wood workers. For making or mending things, it's deservedly America's most popular wood glue.

At all hardware, paint and lumber dealers.

FREE!

HELPFUL LEAFLETS
MAIL COUPON
NOW

Another new WIZARD with WOOD Weldwood PRESTO-SET GLUE

Ready to use! Sets fast! Bonds like magic! It's the perfected white glue, worthy of the Weldwood name. Especially developed for do-it-yourselfers. Doesn't spoil or stain. Works like a wizard on just about everything made of wood, cloth, leather, fibre, paper, etc.



And for a perfect finish, use these WIZARDS with WOOD

FIRZITE®—Use WHITE FIRZITE on any wood to get those rich "woody" blond or pickled effects. (For pastel tones, tint with colors-in-oil.) A "must" undercoater on fir plywood. Use CLEAR FIRZITE to tame that wild grain on fir plywood.



SATINLAC®—For that costly hand rubbed look when you want a natural finish on wood. Heightens and preserves the full beauty of any wood; doesn't "yellow" or darken with age.



UNITED STATES PLYWOOD CORP., Dept. 237, 55 W. 44th St., New York 36, N. Y.

Send me leaflets on:

- Weldwood Contact Cement Weldwood Plastic Resin Glue
 Weldwood Presto-Set Glue Firzite Satinlac

NAME _____

ADDRESS _____

CITY _____

STATE _____

FILE KNOW-HOW

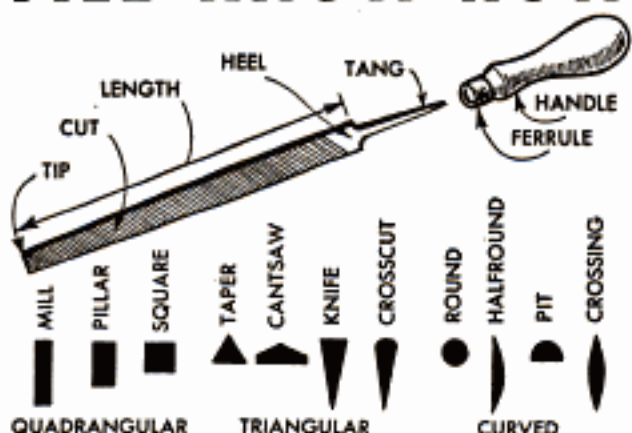

SINCE A SELECTION of files is a must for every homeowner's tool kit, you should know something about the files available to make a wise selection. There are files of various shapes, types and cuts to suit any kind of work and for use on different materials. In the illustration above, the different shapes and types are silhouetted and named. The shape indicates at a glance the type of work a file will do. The teeth of a file may be single-cut, double-cut, rasp-type or curved, as shown in the photo below. Single-cut files are used chiefly for finishing work under light pressure. Double-cut files remove material faster, but require more pressure. Rasp teeth are a series of individual, disconnected teeth for extremely rough work, chiefly in wood, leather and soft metals. Files having curved teeth are single cut and are used mostly on soft metals. A sharp file cuts with very little downward pressure, although this varies with the depth of bite and the material being cut. But with a sharp file, practically no pressure is required for finishing cuts. Too much pressure dulls the teeth, and insufficient pressure, which allows teeth to slide over the work without cutting it, also tends to dull teeth. Files should be stored in moistureproof wrapping as rust destroys the sharp edges of the teeth.

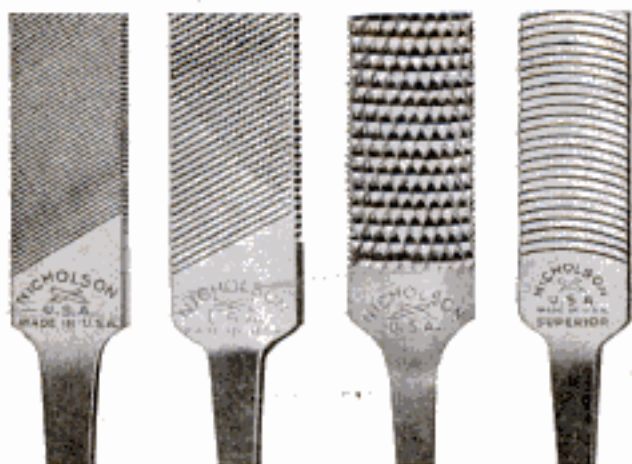

MAKE A

Xmas Gift

FOR YOUR HOME

OUTDOORS—These gay holiday figures send an old-fashioned Christmas greeting from roof, porch or lawn. Build these 30" and 40" figures with minimum time and expense. Simply trace the full-size Easi-Bild* Pattern onto the material and cut out. Full instructions, and directions for decorating, are included with each pattern. The coupon below is your order form.

The major material used is Homasote Type RD. Weatherproof and crackproof, this strong material saws and nails easier than wood, takes any paint or stain, lasts for years — indoors or out.

INDOORS—The unusual valance-bookcase, shown at the right, frames your windows — offers ample space for books, record albums, etc. — conceals the curtain rod. This is only one of 18 practical make-it-at-home suggestions to be found in the three new Homasote "idea" folders. Plans for chests and cabinets, details for a room in the attic, warmer, quieter floors, or a waterproof cellar — all are to be found in these folders. To secure all 3 booklets — a valuable addition to your make-it-at-home file — kindly include 10¢ for handling costs.



*T. M. Reg. Easi-Bild Pattern Company

MAKE it at home...with HOMASOTE

HOMASOTE CO., Dept. 29A, Trenton 3, N. J.

I enclose for which send the following
 3 folders—10¢ Santa Claus Pattern—35¢
 Reindeer Pattern—35¢ Sleigh Pattern—50¢
 Jolly Snowmen Pattern—35¢

NAME.....

ADDRESS.....

CITY.....ZONE.....STATE.....

My lumber dealer is.....

The *Rez* Finishing System

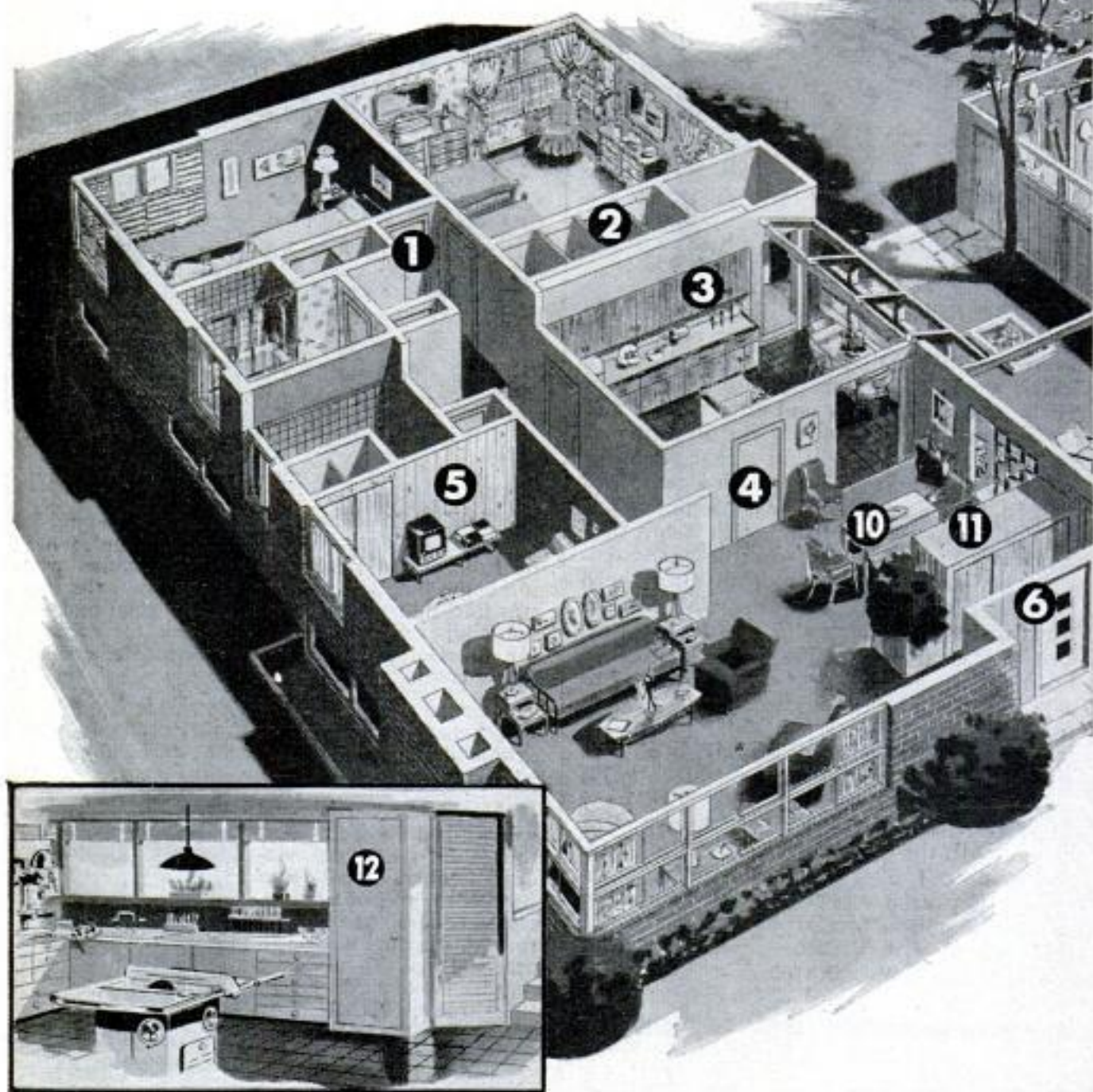

Where there's wood, there should be REZ—to beautify, to protect. Beauty that lasts—protection against moisture, warping, swelling or cracking.

Rez Penetrates the Pores of the Wood. Rez does more than just coat the surface. Rez *bonds* with wood, sinks deep into the pores, brings out *full* color and natural beauty, gives you a uniformly smooth surface.

Rez... A Family of Finishes. Rez is a *family* of related products that answer all your wood finishing problems—for interior or exterior use. No matter where you plan to use wood, the Rez finishing system offers unusual benefits for you.

VALUABLE BOOKLET!

Send 10¢ for "How to Create the Finest Wood Finishes" to: Monsanto Chemical Co., Merchandising Division, Dept. PM-1, 800 N. 12th St., St. Louis 1, Mo.

... a better way to protect and beautify your Popular Mechanics home

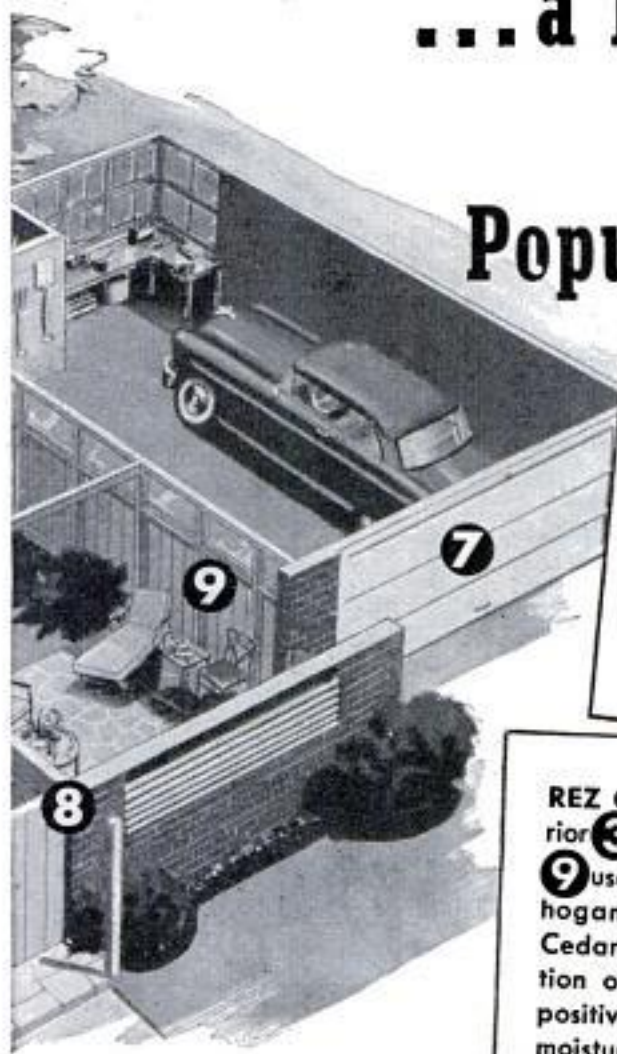

REZ SEALER AND PRIMER—colorless. For interior finishing **1 2**. Also as a primer coat for interior **3 4 5** or exterior **6 7** use. Prevents "grain raise, presents a uniformly smooth surface for easy application of stain, paint, or enamel.



REZ COLOR-TONES — for interior **3 4 12** or exterior **8 9** use. Come in Redwood, Mahogany, Sage, Driftwood and Cedar—or intermix for the creation of your own tones. Offer positive protection against sun, moisture, climatic deterioration.



WHITE REZ—blondes without chemical bleaching **10 11**. An easy, 2-step way to achieve light surfaces favored today.



SATINWOOD REZ—finishes surfaces to a pleasing, satiny sheen formerly achieved only with laborious hand rubbing **3 4 5 10 11 12**.



MONSANTO CHEMICAL COMPANY
Merchandising Division

LAUX
Rez®

Becomes part of the wood

SOCK—
without **SHOCK**

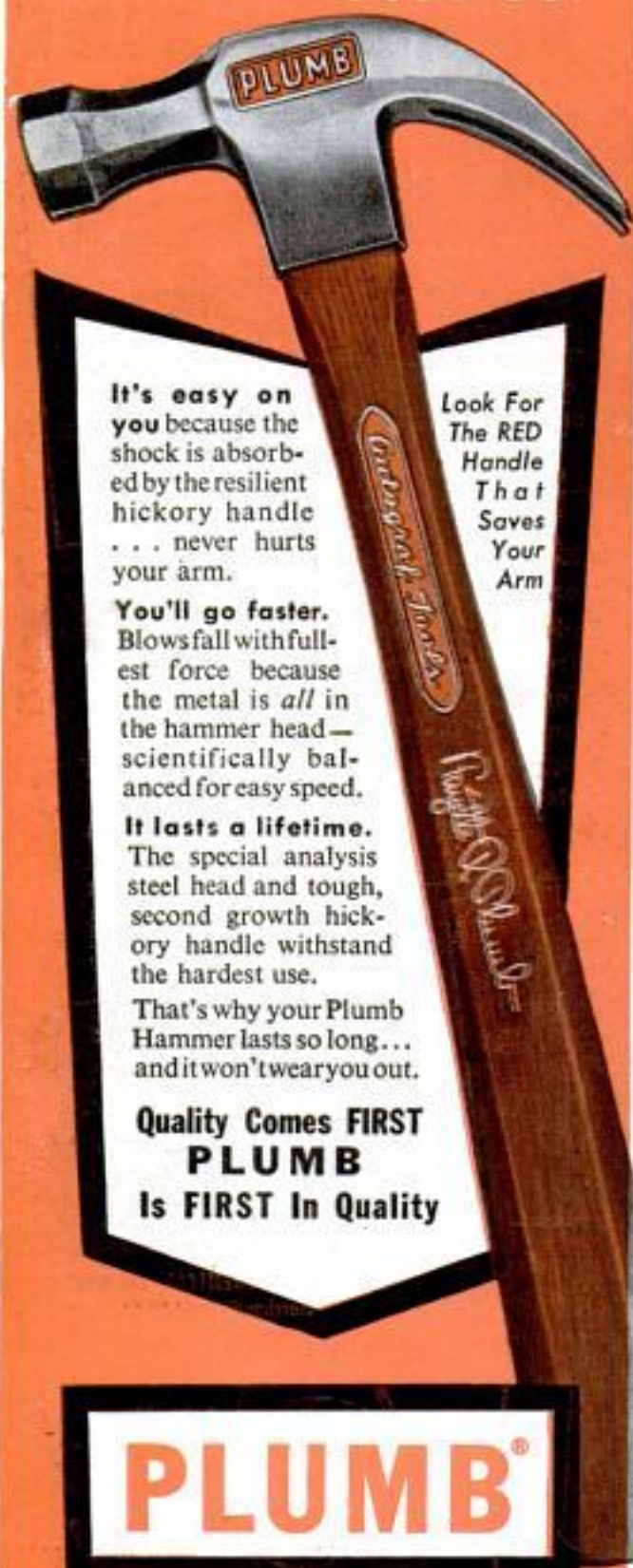

It's easy on you because the shock is absorbed by the resilient hickory handle . . . never hurts your arm.

You'll go faster. Blows fall with full force because the metal is *all* in the hammer head—scientifically balanced for easy speed.

It lasts a lifetime. The special analysis steel head and tough, second growth hickory handle withstand the hardest use.

That's why your Plumb Hammer lasts so long . . . and it won't weary you out.

Quality Comes FIRST
PLUMB
Is FIRST In Quality

PLUMB®

HAMMERS • HATCHETS • AXES • FILES

Look For
The **RED**
Handle
That
Saves
Your
Arm

Compact
WORKBENCH
for the Home Shop



MAXIMUM WORK SURFACE and storage area in the smallest amount of space are the features of this bench designed for small-shop or garage use. The heavy plywood bench top is 4 ft. long and 20½ in. wide, including a built-in hopper for small parts and tools. The roomy storage drawer is 10 in. deep and extends the full length of the bench. Posts, feet and top rails of the bench are 2 x 4s, with 2 x 2s being used for the center and bottom rails. All joints are tenoned and notched for neat

(Continued to page 302)

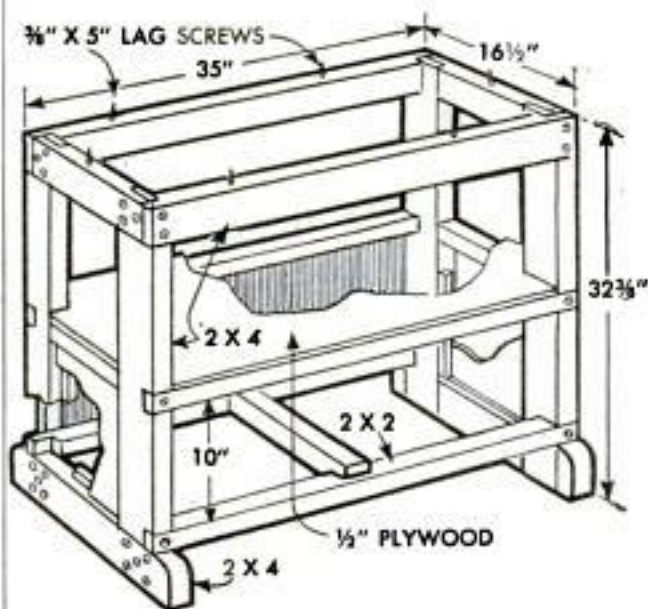

BE SURE YOUR NEW SAW HAS THIS

advanced
**TILT/ARBOR
BOX MECHANISM**



STYLED BY
HARLEY EARL
DESIGNERS

*Greatest new achievement in
Power Tool design!*

**NOW UNPRECEDENTED
ACCURACY, EFFICIENCY**



ADVANCED BOX CONSTRUCTION and TRIANGULAR BOX ARM, combine to maintain absolute maximum rigidity . . . this is the heart of this great power tool . . . the reason for its exceptional accuracy, smoothness, and ease of operation.

**You can DO so much MORE so much
BETTER with the GREAT NEW *Atlas*
America's Finest CIRCULAR SAW!**

Now, more than ever, your *basic* home shop tool . . . the great new ATLAS table saw. More accurate, more versatile, safer, and easier to use than any other type of saw . . . hand, power, or combination. Now you can rip longer stock and bigger panels. You can miter, dado, and shape with greater accuracy and smoothness. Tilt/ arbor box mechanism gives unprecedented strength, rigidity, and accuracy . . . maintains perfect blade alignment regardless of height, angle or load. Entire mechanism is balanced *with* motor to give effortless, accurate settings. Many other exclusive features, including dual V-belt drive and grip-form miter gauge. Study the new ATLAS before you invest in *any* type of saw or combination tool. See your nearest franchised ATLAS dealer, or write for free literature and dealer's name.

There is an ATLAS power tool for every wood and metalworking requirement; each excels in precision and performance.



Atlas Press Company
Quality Machine Tools Since 1911
ATLAS WOODWORKING POWER TOOLS
ATLAS METALWORKING MACHINE TOOLS
CLAUSING HEAVY DUTY MACHINE TOOLS

1024 N. PITCHER ST.
KALAMAZOO, MICH.

NEW BIGGER ARBOR and sealed-for-life ball bearings . . . a rugged combination assuring smoother performance and longer life.



FAMOUS DOUBLE-LOCKING LIFT-OFF FENCE . . . a single lever quickly locks or releases both ends . . . lifts off at any position . . . has Vernier for fine adjustment.



NEW PUSH-PULL DUAL CONTROL one convenient hand-wheel sets blade height and angle, turns with a feather-touch . . . bigger tilt gauge is easier to read, eliminates setting errors . . . built-in motor switch is always at your fingertips.

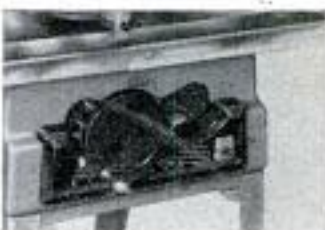

MAIL THIS COUPON TODAY

ATLAS PRESS COMPANY
1024 N. PITCHER ST., KALAMAZOO, MICH.

Please send me FREE LITERATURE checked below and the name of my nearest franchised ATLAS dealer.

____ 10" No. 3061 Circular Saw ____ 8" No. 3021 Circular Saw

NAME _____

ADDRESS _____

CITY _____ STATE _____

Use These 3 Simple Steps to Get Expert Paint Jobs!

Step 1. Prepare surface. Remove all chipped and peeling paint or varnish down to bare wood. Do this by "flowing on" deep-cutting Strypeeze . . . stays wet longer, clings to upright surfaces. Clean off with scraper or #3 steel wool. Won't sting hands. Contains no benzol.



Step 2. Rebuild broken corners, fill nicks and holes with Savogran Wood Putty, a powder-form real wood filler. You can form it, tool it . . . and it doesn't shrink. (For cracks in plaster, use Savogran Crack Filler. It's the original patented quick-hardening water putty.)

Step 3. Start job with clean brushes. Clean old brushes before painting. Clean all brushes after painting and whenever you change colors. Savogran Kwikleeze, the Liquid Brush Cleaner, softens hard brushes in minutes . . . cleans out fresh paint instantly! An excellent deglosser. May be reused.



Whenever you're painting, you need

SAVOGRAN

REG. U. S. PAT. OFF.

PRODUCTS . . . at better paint & hardware stores

Write for FREE helpful literature

SAVOGRAN CO., Dept. 57, 25 Huntington Ave., Boston 16, Mass.

appearance with maximum strength. Note in the detail that the corner posts extend all the way from the bench top to floor. The shelf is of $\frac{1}{2}$ -in. plywood notched to fit around the posts, while the end panels are of $\frac{1}{4}$ -in. plywood or hardboard. The latter are nailed to cleats which have been fastened to the posts and cross members.

The top is made up of two panels of $\frac{3}{4}$ -in. plywood, the lower panel being $20\frac{1}{8}$ in. wide and the upper one $13\frac{3}{4}$ in. wide. These are glued together, with a rabbeted back rail and end blocks added to form the small-parts hopper as shown below. The top is fastened securely to the bench with the lag screws driven up through the bench rails. It should be located so the left-hand side overhangs the bench sufficiently to provide clearance for a vise.

The drawer front is of $\frac{3}{4}$ -in. stock and the sides, back and bottom are of $\frac{1}{2}$ -in. lumber or plywood. Note that the drawer contains two side compartments and a 6 x 20-in. removable tray. Sides, front and back are grooved to receive the edges of the drawer bottom. The grooves must be located high enough to permit installing a standard drawer guide and slide. The guide is shown in the bench-framing detail and the slide is simply a grooved cleat fastened to the underside of the drawer fitted to slide smoothly over the guide. ★★★

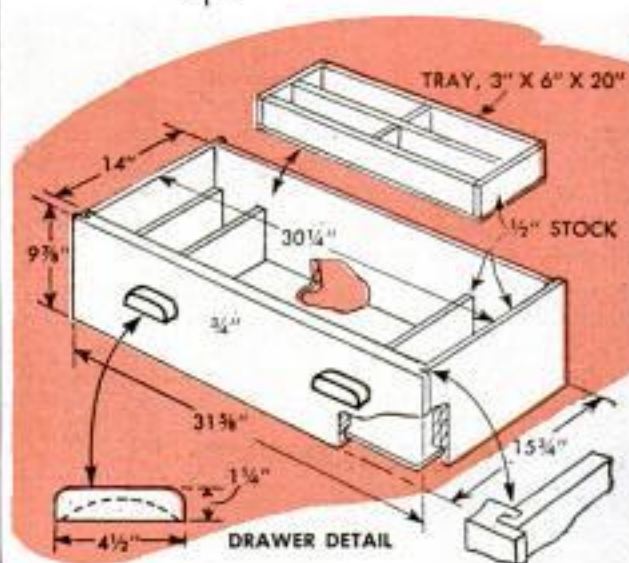
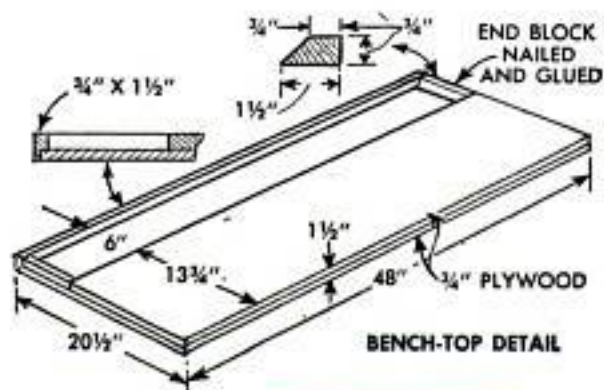



Wood Saws are fine for cutting Reynolds Do-It-Yourself Aluminum. Generally saws with a greater number of teeth per inch will cut more evenly and cleanly.

NEW METAL for HOME PROJECTS PROVES AS EASY TO USE AS WOOD

Reynolds Do-It-Yourself* Aluminum
designed for use with ordinary hand or power tools

At last! A way even *beginners* can better their homes, better their living with do-it-yourself projects made of beautiful long-lasting aluminum. Even *amateurs* get professional results on *hundreds* of easy-to-make projects with this amazing new material.

You saw it, plane it, drill it, shape it, joint it, bend it with tools you have right in your home. That's why it's approved by leading hand and power tool manufacturers.

Reynolds Do-It-Yourself Aluminum comes in a wide variety of sheet designs, in tubing, rods, bars, angles, screen and storm sash, handy fasteners and Reynolon Plastic Film.

Projects to Better Your Home. Here are but a *few* of the things you can make with Reynolds Do-It-Yourself Aluminum. Patterns and plans available (see coupon). Storm Sash • Window Screens • Mail Box • House Numbers and Brackets • Toy Hopper • Fire-place Set • Occasional Table • Study Desk.

Send for **PROJECT BOOK No. 1**—the "idea" book that shows 132 of the countless things you can make with Reynolds Do-It-Yourself Aluminum. Only 50¢ at your dealer's—or send coupon.

See "Mister Peepers," starring Wally Cox, Sundays on NBC-TV



Ordinary wood planes are suitable for planing Do-It-Yourself Aluminum sheet, bar or angle stock. Light cut is recommended for best results.



Look for this handy self-service display rack at your Hardware or Department Store or Building Supply Dealer's without delay.



Reynolds Do-It-Yourself Aluminum has been called the metal you can whittle. You can use a pocket knife to cut it or to remove burrs after sawing.

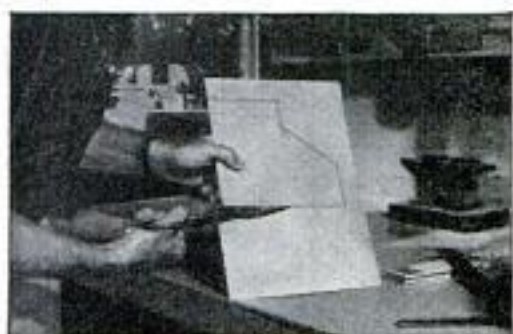

A sharp pair of ordinary household scissors or tin snips will readily cut sheet. Scissors are actually easier to use for more intricate curves.



Power drills may be used or conventional wood expansion bits are very effective for boring holes in sheet. Regular auger bits work equally well.

REYNOLDS DO-IT-YOURSELF* ALUMINUM

* T. N. REYNOLDS METALS COMPANY



Reynolds Aluminum Service Corporation
2494 South Third Street
Louisville 1, Kentucky

- Enclosed is 50c. Please send me Project Book No. 1
- Please send me complete information about Reynolds Do-It-Yourself Aluminum.
- Please send me FREE list of Patterns and Plans.

Name.....

Address.....

City..... Zone..... State.....

Reynolds Do-It-Yourself Aluminum is also available in Canada.

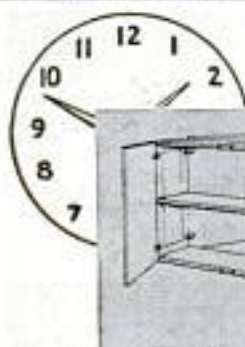

Hanging "island" unit with pass-through shelves.

goes together
FAST!
your
NEW
Curtis
kitchen



Pan storage units come in sizes from 12" to 36". Note sliding tray.

Popular base island unit for use between kitchen and dining area.

Beautiful, natural birch Curtis cabinets—embodying the 53 features women want most—will build your new kitchen in a hurry! You'll get such modern features as swing and revolving shelves—slide-out bins and trays—convenient pass-through units. Curtis cabinets come in sizes to fit *any* kitchen, large or small. In your new or remodeled home, have a Curtis kitchen the quick, easy way! Cabinets are sold through retail lumber dealers everywhere.



KITCHEN IDEA BOOK TELLS ALL. It's colorful—fully illustrated—and just bursting with ideas. Send for your copy!

1866
CURTIS
WOODWORK

Curtis Companies Service Bureau
200 Curtis Building
Clinton, Iowa

PM-10-54

Please send Curtis kitchen idea book. I enclose 10 cents.

Name.....

Address.....

City.....State.....



Sewing-kit LAMP

By I. M. Fenn

ANYONE WHO SEWS will appreciate this lamp that not only provides light for the work, but also keeps the spools of thread handy. The base can be made of wood, or an unusually attractive lamp can be produced using plastics of harmonious colors for the various parts. Cut out the base, drill the holes indicated in the plan and then round off the top edge for a more pleasing appearance. Next cut the pegs and feet from dowel stock. The fixture pipe is fastened to the base with two $\frac{3}{8}$ -in. nuts, one turned against the top of the base and the other into a counterbored hole in the underside of the base. The pipe is covered with large corks drilled to slip over it. The corks may be stained, painted or left their natural color. Now assemble the base, using glue to fasten the parts together. Then push the lamp cord up through the fixture pipe and attach a standard socket.

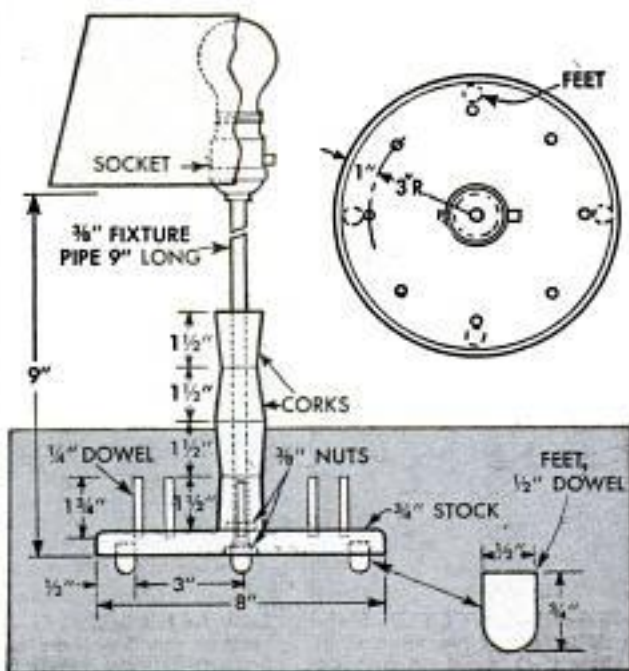



Ask your hands to tell you

You don't have to be a carpenter to want, yes, even to need — fine tools. Put a Stanley tool in your hands. Use it. You'll feel the difference. For everyone from schoolboy to professional
Stanley is the toolbox of the world.

Tool UP With Stanley Take this "100 PLUS", for example. Sure, you can drive a nail with almost any hammer — one way or another. But your hands will tell you *this* one. It hits the nail hard, and drives it straight and deep. You'll get a smacking sense of satisfaction every time you use it.

*Western prices slightly higher.

"100 PLUS"
No. 11½ — \$3.50*

Measure UP With Stanley



No. X226 —
6 ft. — \$2.75

A good rule is a must, and a new favorite is this Stanley '100 PLUS'. It's a good friend, many times tested and all ways true. The joints lock firmly, the square ends stay square, the handy 8-inch brass slide slides but never slips, the easy-to-read numbers are always easy to read. For *more* than a measure of satisfaction, say Stanley the next time you buy a rule.

Tool UP With "YANKEE"®



No. 41 — \$5.65

The "Yankee" push drill is a quick, one-hand worker . . . the ideal tool for boring screw holes. The drill point spirals in easily and the built-in spring returns the handle for the next stroke. You're through in no time. What's more, the magazine handle holds 8 drill points from 1/16 to 1 1/4 inch — the size is always right.



THE TOOL BOX OF THE WORLD

STANLEY Tools

How Long Is Your Square Tongue?

Sure that's a silly question. But if you haven't a steel square you'll never know.* On the other hand, with one of these Stanley rafter squares you can really get on top of things — build a roof, for instance, on your new porch or garage. Send for your free copy of "Rafter and Framing Squares". You'll learn all about roof framing, common rafters, hip and valley rafters, brace measures, etc. Use the coupon.

*The Stanley rafter square tongue is 16" long.

ELECTRIC TOOLS • HARDWARE • STEEL STRAPPING • STEEL

STANLEY TOOLS, 304 Elm Street, New Britain, Conn. or
STANLEY TOOL CO. of CANADA, 304 Stanley St., Roxton Pond, Que.

- Please send me STANLEY TOOL GUIDE for which I enclose 25¢.
- Please send me FREE "Rafter and Framing Squares" — S51.
- Please send me FREE "YANKEE" Tool Book Y41.

Name _____

Address _____

City _____ Zone _____ State _____

HOW TO QUIET YOUR CAR

—and do "1001" jobs around the house



FREE "Tips to the Handyman" folder shows over 40 ways you can use L·O·F Super·Fine.



This handy free folder shows you how to do a variety of jobs around the house with fine-fibered, easy-to-apply Super·Fine Fiber·Glass. A few of the suggested uses include: **Hot-water tank wrap • Garage-wall insulation • Milk-box liner • Comforter padding • Shrubby wrap • Auto tool wrap.**

Buy Super·Fine from your local hardware, lumber, or building supply dealer.



FIBER·GLASS

Libbey-Owens-Ford Glass Company
Fiber-Glass Division
48-104 Wayne Building
Toledo 3, Ohio

Please send me, FREE "Tips to the Handyman" folder, showing how to quiet my car and make over 40 household improvements with Super·Fine Fiber·Glass.

Name _____

Address _____

City _____ Zone _____ State _____

The most essential ingredient in any gluing operation is the gluer's know-how. First of all he must know his glues, as the choice of the right glue will do much to make any glue job a success. Finding a good glue to suit the job is not difficult with the wide variety being offered today.

Hide Glue: This has long been acknowledged as the best for all-around woodworking. The liquid hide glues now on the market are as strong and durable as the old flake variety, and much easier to use.

Fish Glue: Made by many manufacturers, fish glues are another all-purpose woodworking glue. Experts say that they are not quite as strong as hide glue.

Liquid Resin Glue: These glues look like thick milk. They are not quite as strong as hide glue for woodworking, but are ideal for model work, leather, paper and general household purposes.

Resorcinol Glue: This is a powder that must be mixed with a liquid catalyst. The resulting mixture is a completely waterproof glue for outdoor and marine use.

Powdered Resin Glue: Mixed with water, this powder makes another completely waterproof glue. Excellent for woodworking and any job where moisture may affect the joint.

Powdered Casein Glue: While not as popular as it once was, this glue has the advantage of working well in cold places, and is especially suitable for use with oily woods such as teak, lemon and yew.

Cellulose Household Cement: This has been a standard for modelmaking for years and is fine for pottery repairs.

Black Mastic Cement: These cements give good adhesion and are waterproof. Used for bonding metals and for tile and linoleum.

Rubber Adhesives: Widely used for paper work and for making rubber repairs, these glues are becoming important in furniture upholstery work as more and more foam rubber is used.

The Flexible Cements: Various types and brands are available, and the biggest use is in joining porous materials to metal or glass. Since they remain flexible after drying, these cements won't lose adhesion on a contracting or expanding surface.

Vegetable Glues: Library and wallpaper pastes are typical vegetable glues. They are used primarily on paper, since their adhesion to other materials is limited.

Try My "FAMILY FORMULA" For
GETTING YOUR COMPLETE WORKSHOP

Build your one-motor
DELTA SHOP this ideal way—
A TOOL AT A TIME!



FIRST I BOUGHT THE
BASIC SAW AND STAND



... and that gave me the tool to do the sawing operations that are needed on every job. The DELTASHOP'S big tilting blade saw does many other important operations, too—such as cutting grooves, decorative moldings, etc.—and its accuracy helps me do work like a professional.

Saw and stand, less motor \$109⁰⁰

LATER, MY WIFE GAVE ME
THE COMPANION JOINTER-PLANER



To do any finished-looking job you must plane the edge of a board right after you rip it. The Delta jointer planes boards up to 4" wide . . . does operations such as tapering and rabbeting, too.

Jointer, complete \$49¹⁵

THE DRILL PRESS WAS A
GIFT FROM MY FOLKS



In addition to doing accurate drilling, the Delta drill press made it possible to make mortises, do routing, carving, sanding, polishing, make beautiful shaped edges . . . actually it's a "master of all trades."

Drill Press . . . \$57⁵⁰

MY KIDS JOINED FORCES TO
GIVE ME THE SANDER



This handy, low cost tool is perfect for finish-sanding jobs—has many other uses, too.

Sander . . . \$17⁵⁵

Ask about the DELTASHOP "tool-at-a-time" plan today—at your Delta dealer, department store or nearby hardware store. Then start building your complete workshop this easy, low-cost way. Delta Power Tool Division, Rockwell Manufacturing Company, 502K N. Lexington Avenue, Pittsburgh 8, Penna.

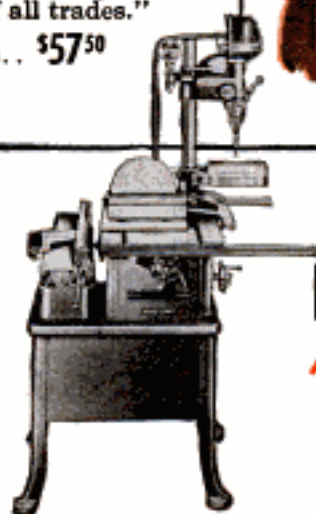

Prices slightly higher west of the Rockies.

DELTA QUALITY POWER TOOLS

Another Product by

Rockwell



DELTA QUALITY
MAKES THE DIFFERENCE!



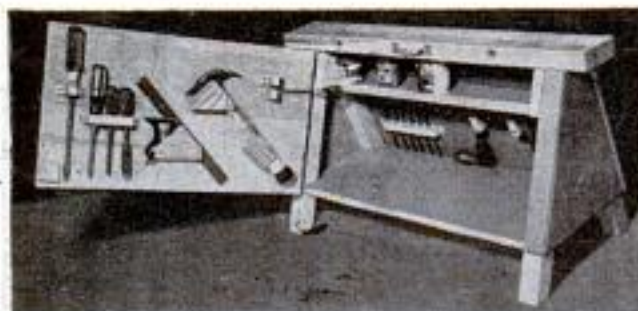

SAWHORSE-TOOL BOX

Now you can build a combination sawhorse and tool-box that answers the handyman's problems of where to keep his hand tools and where to do sawing, planing and hammering. The plan gives all the details except those of the tool racks, which are made to suit your own tools. A shoulder strap may be added for carrying

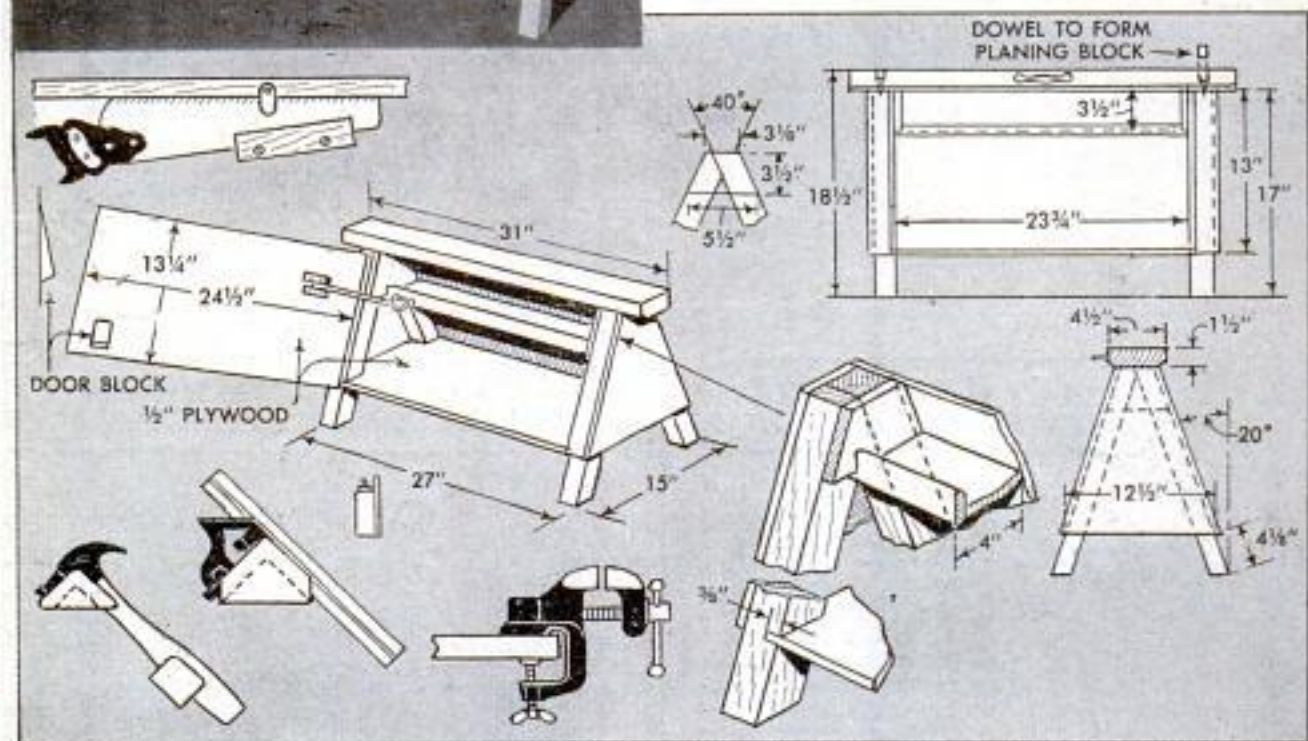

**Stop Costly
HEATING**

Leaks

It's easy with Smooth-On No. 1, the IRON Repair Cement. Smooth-On expands as it hardens, fills cracks and holes to stay put. Withstands heat, steam, water, gases, and smoke. Stops up those unnecessary openings in conversion jobs and saves fuel.

FREE Repair Handbook



48-page—illustrated edition, gives you full details on these and dozens of other repairs. Ask your hardware dealer for a copy or drop us a card. Sent postpaid.

50-404

SMOOTH-ON MANUFACTURING COMPANY, Dept. 37K
572 Communipaw Avenue, Jersey City 4, New Jersey

SMOOTH-ON



POPULAR MECHANICS

THE
BASIC
SHOP TOOL



9" x 3' Model C Bench Lathe \$211 f.o.b. factory.

9" SOUTH BEND LATHE

This South Bend 9" Precision Lathe is the basic tool for your shop. It enables you to perform accurately the same full range of operations done on South Bend Lathes in industry. Also, operations ordinarily performed on other machine tools are made possible through the use of efficient attachments. You get more for your money in a South Bend 9" Lathe.

Write for catalog — see local distributor — look under "Machine Tools" in your classified telephone directory.

NEW 14" DRILL PRESS—a ruggedly built tool unsurpassed for accuracy and dependability. Prices start at \$87, f.o.b. factory.

Write for catalog.



SOUTH BEND LATHES WORKS

Building Better Tools Since 1906

455 EAST MADISON STREET, SOUTH BEND 22, INDIANA

A Few of the Many
Operations You Can Perform



TURNING



BORING



THREADING



FACING



MILLING



GRINDING

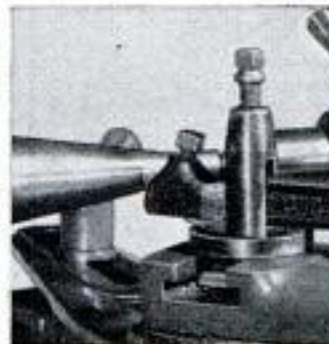

TAPER TURNING



WOOD TURNING

X 803



ask for
IRWIN auger bits
World's finest wood-boring tools

Irwin Auger Bits make any boring job easier. They're precision made of special bit steel—heat-treated, tempered, hardened full length for longer life. Cutting heads stay sharp job after job. Original solid center design adds extra strength for steadier, cleaner, more accurate cuts. No binding, no clogging. Ask for Irwin at your independent hardware dealer—the auger bit that bores true... clean through.

IRWIN 62T Solid Center Auger Bit— sizes $\frac{1}{4}$ " to $1\frac{1}{2}$ ". Double cutter head. Open throat for quick chip clearance. No binding, no chewed edges.

IRWIN All-Purpose Expansive Bits— two types, small and large sizes. Boring range $\frac{3}{8}$ " to 3". Accurate, easily adjusted. Two cutters with each bit. Individually packaged.

IRWIN Bit Sets— in hardwood box or plastic rolls. 6, 10 or 13 bit assortments. Sizes $\frac{1}{4}$ " to 1". Ideal gift for handyman or professional.



FREE! Useful booklet tells, How to Select, Use, Care for Auger Bits. Send name and address to IRWIN, Dept. 10, Wilmington, Ohio.

IRWIN

the original solid center auger bit
screw drivers
screw driver bits



How to Buy WOOD SCREWS

WHEN BUYING wood screws, you should know what to specify and the correct order in which this information is given, so that you will get exactly what you want. This is the accepted practice: (1) length; (2) gauge number; (3) type of head—flat, round or oval; (4) material—steel, brass, bronze, etc.; (5) finish—comes in bright steel, blued, cadmium, nickel or chromium plated. Example: $1\frac{3}{4}$ -in. No. 10 flat-headed-steel, cadmium-plated wood screw. Keep in mind that the proper screw to be used on a job must be thick enough to resist shearing and long enough so that the entire threaded section enters the piece to which you are fastening something.

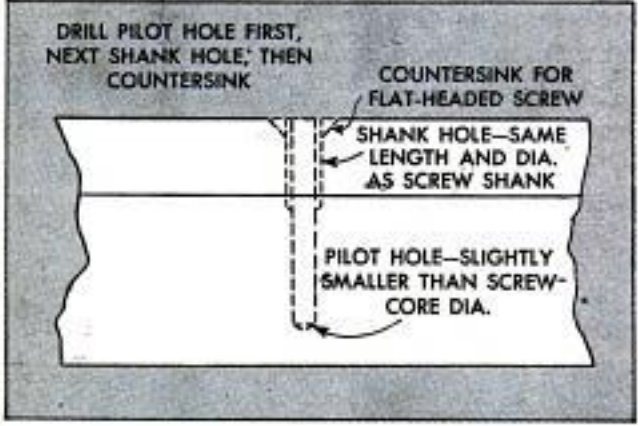
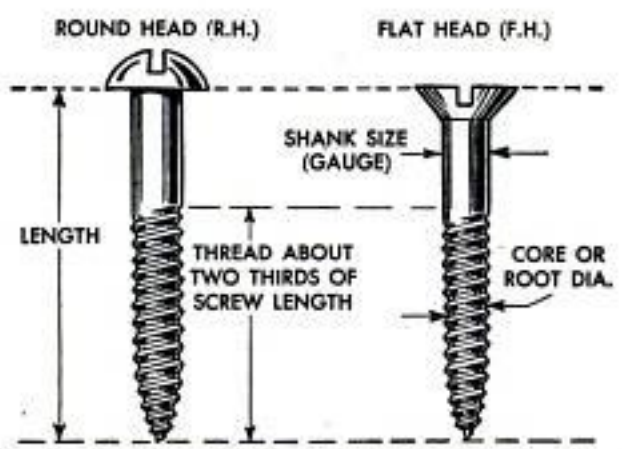

Gauge Numbers of wood screws, with the diameter shown to the nearest 64th of an inch.

Ga.	Dia.	Ga.	Dia.	Ga.	Dia.
0	$1/16$ "	6	$9/64$ "	12	$7/32$ "
1	$5/64$ "	7	$5/32$ "	14	$15/64$ "
2	$5/64$ "	8	$5/32$ "	16	$17/64$ "
3	$3/32$ "	9	$11/64$ "	18	$19/64$ "
4	$7/64$ "	10	$3/16$ "	20	$21/64$ "
5	$1/8$ "	11	$13/64$ "	24	$3/8$ "

USE HARDWOOD PLYWOOD

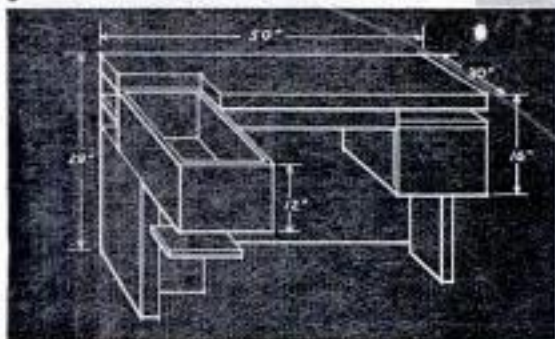

For PROFESSIONAL- Looking "Do-it-Yourself" PROJECTS

You've admired the beauty and graining of Hardwood Plywood in the finest furniture and wall paneling—now use it as your own material. Nothing lends as rich an appearance to Do-It-Yourself projects as genuine hardwood plywood—and the price is far less than you'd expect.



Wall paneling, built-ins, ceiling light soffit, and matching desk of Birch Hardwood Plywood.



LOOK FOR THE HARDWOOD PLYWOOD INSTITUTE SEAL ON EVERY HARDWOOD PANEL YOU BUY

The H.P.I. seal means that the mill producing the wood you choose has met the rigid 8-point quality inspection of the Hardwood Plywood Institute... five times as exacting as Commercial Standard... from log selection through cutting, drying, bonding, finishing and grading. It's your assurance of uniform, consistent quality.

ONLY HARDWOOD PLYWOOD OFFERS UNLIMITED NATURAL BEAUTY

Why not explore the world of beauty that's as near as your local lumber yard? Hardwood Plywood (and only Hardwood Plywood) offers an endless variety of texture, grain, and color in such rich woods as: Birch, Gum, Mahogany, Maple, Oak, Walnut—plus a truly wide choice of beautiful woods from all parts of the world.

What's more, you'll find Hardwood Plywood much easier to finish whether you use it for paneling, built-ins, fine furniture, plywood floor tiles, or scores of other uses.

ASK YOUR LUMBER DEALER ABOUT HARDWOOD PLYWOOD

HARDWOOD PLYWOOD INSTITUTE

600 South Michigan Avenue • Chicago 5, Illinois

MAN-SIZED TIE RACK



HERE'S A TIE RACK any man would like to own because it offers some real advantages. Even when it is fully loaded, every tie is visible; and it lies flat against the closet door, taking a minimum of space. It is made of $\frac{3}{8}$ -in. dowels set in a wooden frame which is hinged to the supporting surface. Finishing nails driven through the dowels act as dividers to keep the ties from overlapping. Drill holes for the nails to prevent splitting the dowels. To drill the side pieces of the frame for the dowels, nail them lightly together and drill both sides simultaneously. The frame is assembled with glue and dowel pegs, as shown in the detail. To finish the rack, apply a stain of the desired color and then give it several coats of varnish.

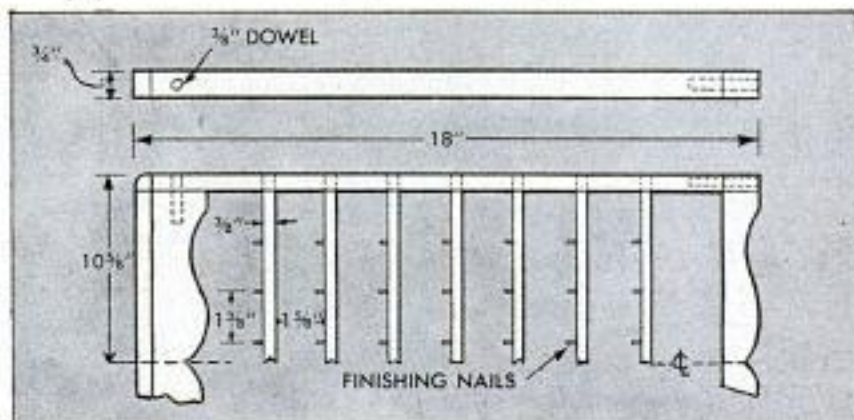

I built this
for less than
\$25



Build a Better Awning with

PLEXOLITE

TRANSLUCENT SHATTERPROOF PANELS

With PLEXOLITE'S "step-by-step" brochure, anyone can build an awning of lasting beauty. Ordinary tools are all you need. For name of nearest dealer and free brochure, mail coupon today!

Use PLEXOLITE for Modern Living...Indoors and Out



For Patio and
Porch Roofs



For Car Ports
and Fences



For Planters and
Room Dividers

FREE

PLEXOLITE DISTRIBUTING CO., INC.
4223 W. Jefferson Blvd., Los Angeles 16, Calif.

HOW TO BUILD AWNINGS HOW TO BUILD PATIO & PORCH ROOFS

Name

Address

City Zone State

© 1954 PDC PM 1054

THE GREATEST INVENTION SINCE THE HAND SAW . . .

New **Amf** DeWalt "Power Shop" brings out the expert in you!

Today, AMF DeWalt® "Power Shop" is everywhere known and accepted as the one really safe, accurate, easy-to-use machine. It's so designed that even the inexperienced can *expertly* do everything in home woodworking.

Whether you're modernizing, decorating or repairing your home, AMF DeWalt is your best investment. See it demonstrated today. At your DeWalt Dealer's or fine hardware and department stores.



\$229 delivered (saw blade and custom-built 1/2 H. P. motor included). EASY TERMS.

All these exclusive extra-value advantages!



TOP-SIDE CUTTING! No guesswork—no mistakes. You always see the cut because layout marks are visible and easy to follow.



PROFESSIONAL ACCURACY! Calibrated scales for miter, bevel and rip are visible above table. Instantaneous settings!



EASY TO USE! You control ball-bearing travel head in radial arm. Moves smoothly, precisely. All cuts perfect—no spoilage.

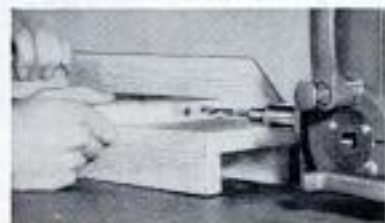

COMPLETE VERSATILITY! One powerful direct-drive motor accommodates any circular tool—gives full home workshop flexibility.



NO FLOOR SPACE NEEDED! Builds into your workbench! When not in use radial arm swings conveniently out of way, freeing work area.



HOME SAFETY FEATURES! "Stop" red controls, UL*-approved motor, safety key switch, auto-float safety guard (optional).

*Underwriters' Laboratories, Inc.

PLUS BIG CAPACITY and many more extra-value features—all explained in new FREE 20-PAGE COLOR BOOKLET!

Another **Amf** Product

DEWALT
POWER TOOLS

DeWalt Inc. • Lancaster, Penna., U.S.A.
IN CANADA: DeWalt Canada Ltd., Guelph, Ontario

Send this coupon today!

AMF DeWalt, Dept. PM-54-10, Lancaster, Penna.

Please send me free illustrated booklet "The Greatest Invention Since The Hand Saw" showing how your Power Shop makes me a woodworking expert, saves money in my home.

Please send me free blueprint "Building A Home Workbench."

Name.....

Address.....

City.....Zone.....State.....

New

**MOST WEAR-RESISTANT
WHITE LINE IN A NEW
FEATHERWEIGHT CASE**

LUFKIN

WHITE-CLAD

MEZURALL TAPE-RULE

98¢
6 FOOT

"MAGIC METAL" CASE

New alloy metal makes this the lightest, yet toughest and strongest die cast case on the market.



6, 8, 10, 12 FOOT LENGTHS

- Tough white finish protected by newly developed abrasion-resistant clear plastic.
- Bold black figures are easy to read against the snow-white background.
- Self-adjusting hook—originated by Lufkin—gives accurate butt-end and hook-over measurements.
- Blade replaceable in seconds.

■ **FOR EXTRA HEAVY DUTY!**



New Super Mezurall with $\frac{3}{4}$ " wide line is available in 10 and 12 ft. lengths.

● **FREE "SEE THRU" PLASTIC BOX**



Each "White-Clad" packaged in 2-color re-usable plastic box with hinged cover and snap fastener.

316

BUY THE **LUFKIN** WHITE CLAD NOW
AT YOUR HARDWARE OR TOOL STORE
THE LUFKIN RULE COMPANY
SAGINAW, MICHIGAN

SANDING ON A DRILL PRESS

RAPID AND ACCURATE sanding of both edges and surfaces of wood can be done by using one of two attachments chucked in a drill press. The attachments are a sanding drum, which does an excellent job on edges, and a 4-in. rubber disk which produces surprisingly good results on flat surfaces. An auxiliary plywood table clamped or bolted to the drill-press table, as shown in the upper right-hand photo, provides a larger work surface. The work is disk-sanded by placing it on a piece of wood to which an L-shaped stop has been nailed. The stop holds the work as the piece of wood is pushed across the auxiliary table under the disk. The lower right-hand photo shows the drum sander being used to sand a curved edge. In this case, a length of lumber is clamped to the regular drill-press table to raise the work sufficiently to allow it to be held against the drum. For best results, use a drum of the largest diameter practical for the job

(Continued to page 316)



Upper photo shows sanding disk in use on drill press. Work held by stop nailed to piece of flat wood is pushed under revolving disk. Below, drum is used to sand curved edge of plywood. Practice with the drum sander is required to follow along a scribed line



SURFACE YOUR OWN

Sink Top or Furniture

with
genuine

FORMICA



FREE!

complete step-by-step
instructions, samples
and where to buy.

Write... **FORMICA** 4711 SPRING GROVE AVE.
CINCINNATI 32, OHIO

HOW TO CHOOSE A GLUE



For fast, clean, light-weight gluing of wood, paper, fabric—use **ELMER'S GLUE-ALL** in the new flexible squeeze-bottle. 8 oz. workshop size—\$1.00.



For stain-free, highly water-resistant veneering or cabinet work... use **CASCAMITE** urea resin glue. Easily mixed in cold water. The most widely used type of glue in the furniture industry.



For counter tops, laminating and other heavy-duty rough gluing... use **CASCO** Grade A Powdered Casein glue. Mixed in cold water. Cures at any temperature above freezing.



For boats, outdoor furniture and all bonds to be exposed to water, weather, acids, alkalis, etc.—use **ELMER'S WATERPROOF GLUE**... the most durable type of wood glue available. The best you can buy. At marine supply, hardware and lumber dealers.

SEND FOR FREE DESCRIPTIVE FOLDERS
THE Borden COMPANY, CHEMICAL DIVISION
Dept. PM-104, 350 Madison Ave., New York, N. Y.

REPLACING SCREENS?



This booklet tells how to do
a job that will last for years.

In clear, easy-to-follow directions, this tells how to replace your worn-out screens with Alcoa® Aluminum Screening. Low cost aluminum screening, woven from Alcoa Alclad Screen Wire, will last for years—won't stain your sills and siding.

Better hardware stores and building supply yards carry Alcoa Screening. Look for the Alcoa label. Send in coupon now.

ALCOA 
ALUMINUM
ALUMINUM COMPANY OF AMERICA

Aluminum Company of America
1931-K Alcoa Building, Pittsburgh 19, Pa.
Please send a copy of your booklet that tells
how to install Alcoa Aluminum Screening.

Name _____

Address _____

City _____ State _____

you have at hand.

Several types of fences can be made that will permit more rapid and accurate sanding than may be done freehand. The upper photo shows a fence used with the drum, the fence being a length of straight board in which a hole has been jigsawed to accommodate the drum. The hole is oversize and allows the drum to project slightly past the edge of the fence. The edge of work passed across the drum will be sanded the amount of the projection.



The upper drawing shows a standard fence and the other drawing shows a sanding disk being used to bevel a cabinet door. The fence shown in this drawing consists of two pieces of straightedged scrap aligned and clamped to the auxiliary table.



The table is blocked up at a slight angle to produce a bevel on the door. The photo at the bottom of the page illustrates a fence which is a length of lumber notched to clear the sanding disk. Long bolts pass through the fence, spacer blocks and lengths of lumber which fit under the auxiliary table. Wing nuts on the bolts clamp the fence to the table. In the photo a piece of flat stock is being surface sanded.



In most cases, with either drum or disk, the drill press should be run at fairly high r.p.m. The higher speed produces fewer sanding lines and helps keep the sandpaper from becoming clogged. ★ ★ ★



NO
NAILS
NO
BOLTS
NO
SCREWS



WITH **Jiffy** SAWHORSE BRACKETS

ALL WELDED construction. Use any 2x4's for legs and cross bar.

SET UP OR knocked down instantly. Easy to move from job to job, and easy to store.

FOR SALE BY most hardware and lumber stores. If your dealer cannot supply you, write us direct.



At Work



At Home



GRAND HAVEN STAMPED PRODUCTS CO.
GRAND HAVEN, MICH.

READY PATCH



Preferred by
HOMEMAKERS and
PROFESSIONAL USERS

- Fills cracks and joints economically
- Ready-mixed . . . ready to use!
- Will not dry out in can

At your Local Hardware and Paint Stores

M & H LABORATORIES
2705 ARCHER AVENUE
CHICAGO 8, ILLINOIS

SAY YOU SAW IT IN
POPULAR MECHANICS

**CLING-SURFACE
V-BELT DRESSING**

can SAVE you many dollars in

★ A few drops of Cling-Surface stops squeaking and slipping belts on washers, driers, refrigerators, water pumps, home power tools, air compressors, power lawn mowers, furnace blowers, garden tractors, etc. If your dealer can't supply you

SERVICE BILLS!

Send 50¢ to: CLING-SURFACE CO.
1047 Niagara St. Buffalo, N. Y.
Canada: send 75¢ to CLING-SURFACE CO.
243 College St. Toronto 2, Ont.



Use good files on your

DO-IT-YOURSELF
PROJECTS



You really get the urge to make and repair things when the files you use are Nicholson or Black Diamond. There's a rare crispness in their bite, economy in their long-lasting sharpness, satisfaction in knowing that you have the world's finest.

The man in the picture is finishing off a pair of hardwood book ends, but even his modest assortment of these *good* files can take care of scores of jobs around the house, garage and workshop.

It's worth while going out of your way to get Nicholson or Black Diamond files, but most good hardware and tool-supply houses have them . . . because they know that "once a customer, you're *always* a customer."

FREE BOOK,
"File Philosophy,"
will help you on your Do-It-Yourself projects. It has 48 illustrated pages on kinds, use and care of files. Send for it.



NICHOLSON FILE CO.
22 Acorn Street
Providence 1, R. I.

(In Canada: Nicholson File Company of Canada Ltd., Port Hope, Ontario)

**NICHOLSON
FILES** FOR EVERY PURPOSE

TIME SAVING TIPS

ALL YOU NEED IS A TUBE OF

DU PONT DUCO CEMENT

REG. U. S. PAT. OFF.



MAKE FISHING LURES and secure loose line guides with tough, waterproof Du Pont "Duco" Cement.



LOOSE WINDOW STICKERS need not flap or peel off. Replace with transparent Du Pont "Duco" Cement.



CHIPPED KEYS strike a sour note in a piano's appearance. Mend broken keys with "Duco" Cement.



TIPS FOR SHOELACES. When metal or plastic tips break off laces, form new tips with "Duco" Cement.



A WATCH CRYSTAL won't keep popping out when you use transparent "Duco" Cement to hold it in place.



INDOOR TV ANTENNAS won't mar polished surfaces when felt bases are attached with "Duco" Cement.



NAME PLATES IN OVERSHOES prevent mix-ups in the school coatroom. Put them in with "Duco" Cement.



REPAIR CHIPPED GLASS. The transparency of "Duco" Cement makes the repair neat—almost invisible.



BETTER THINGS FOR BETTER LIVING
... THROUGH CHEMISTRY

HOT-ROLL SERVER



ROLLS ARE kept hot and handy in a server fitted with a hinged hammered-copper lid which is lifted by the thumb of the hand holding the server. The sides and bottom are 1/4-in. hardwood and the back and handle are 3/4-in. stock. A hole mortised through the back receives the tenon on the handle and the back also is rabbeted for the bottom. The lid is cut from sheet copper and hand-hammered. The handle riveted to the lid is a strip of copper.

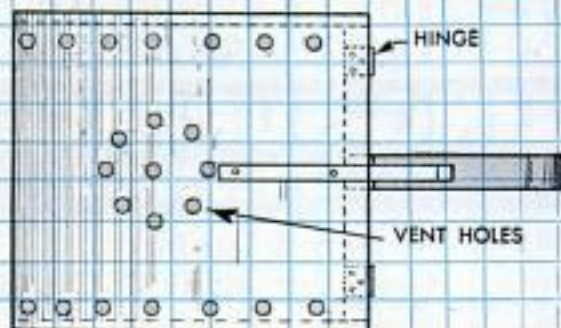

NEW!

TRU-CUT
Magnetic Miter

LIGHTWEIGHT! DURABLE!
COMPACT! EXACT!

\$2.95

COMPLETE MITER & PROTRACTOR



DESIGNED BY LAWRENCE BRUCE, JR.

MAGNET GUARANTEED FOR LIFE!

MAGNETIC WALL STUD FINDER
An amazing wall and time saver... the MAGNETIC WALL STUD FINDER is proven as one of the hottest selling and most needed items in the hardware field today! No longer is it necessary to tap walls... hunting for an elusive stud... merely move the stud finder along the baseboard and mark where the magnet is activated! Simple and sure... plus saving the wall, time and temper!
\$1.00

DRESDEN

HOLDS SAW IN PLACE
A powerful magnet holds the saw against the miter face yet allows free and easy horizontal movement... without damage to saw teeth!

ADJUST TO ANY ANGLE
It's easy to adjust... merely loosen wing nut with one hand and move protractor to exact angle desired!

TRANSFER ANGLES
No need to guess when doing difficult joining... merely place miter against angle to be copied and tighten wing-nut!

● This great, new TRU-CUT MAGNETIC MITER is an ideal precision tool... engineered to exact specifications! Lightweight and durable... it may be folded and carried in the pocket or left hanging on the saw when not in use. The TRU-CUT MAGNETIC MITER is a needed must for the journeyman and the "do-it-yourself" home carpenter.

DRESDEN MANUFACTURING COMPANY, 2375 WALNUT AVE., LONG BEACH, CALIF.
also manufacturers of a complete line of tools for the CEMENT, PLASTERING, FLOOR COVERING AND TILE fields

SHARK BRAND



ESKILSTUNA • SWEDEN

SHARK BRAND QUALITY IN WOOD CHISELS

Makes your job easier.

Traditional Swedish craftsmanship combined with Swedish Charcoal Steel produce SHARK BRAND Chisels—the chisels you can depend upon for a lifetime of rugged service.

See the full range of sizes at your hardware store, or write for the SHARK BRAND circular. Dept. PM

Sandvik Saw & Tool

Division of Sandvik Steel, Inc.
47 Warren Street, N. Y. T. N. Y.



FREE

SEND FOR THIS 8-PAGE AUTHORITY

SURFACE PREPARATION SANDING HANDBOOK

THIS SURFACE NEEDS PLANING
Your Sander will level any board —

EVERY "DO-IT-YOURSELF" NEEDS THIS FREE BOOK!

Brand new pocket size handbook explains sanding technique on wood, metal, glass, plastic; shows correct methods and names proper tools for removing surfaces of different types of woodwork, and uses; tells how to sand hard-to-reach places, etc. Helps you save time, money on home projects — invaluable to beginners — experts. Fully illustrated. Send coupon for your FREE copy now.

THESE ARE THE WORDS
Start your sanding after you proper tool to first remove a shly can. You wouldn't use a as a cold chisel — why not Sander (and Yourself) the

NO! NO!

SYNCRO
QUALITY SANDERS



No. 900

NEW HEAVY-DUTY SYNCRO SANDER HAS BUILT-IN "SIGHT-SAVING" LAMP

Husky new "900" removes paint, varnish — outlasted all other portables by running over 1,500 hours without breakdown in exhaustive laboratory tests. Fastest to use. Most powerful reciprocating sander master (patented). Priced LOW. Rush coupon for details!

AMERICA'S FINEST VERTICAL and FINISHING SANDERS are SYNCRO 504-D

(in deluxe metal case) and 504. Priced to save you money!



No. 504-D

Mail Coupon for SANDER CATALOG and NEW HANDBOOK Both FREE!



No. 504

SYNCRO CORPORATION
Dept. 1-74, OXFORD, MICHIGAN

Send my Free 8-page SANDING HANDBOOK. SYNCRO SANDER CATALOG. LOW PRICES!

NAME _____

ST. & NO. _____

CITY _____ STATE _____

PEGGED SMOKING STAND

THE PEG CONSTRUCTION used in this smoking stand has the charm of antiquity and at the same time permits very easy assembly. All parts of the stand except the pegs are cut from $\frac{3}{8}$ -in. birch plywood, while the pegs are made from a strip of $\frac{3}{8}$ x $\frac{1}{16}$ -in. maple. All of the parts should be sanded smooth before they are assembled. For a beautiful blonde finish, rub on a coat of white shellac with a soft, lintless cloth. Or apply any good stain.

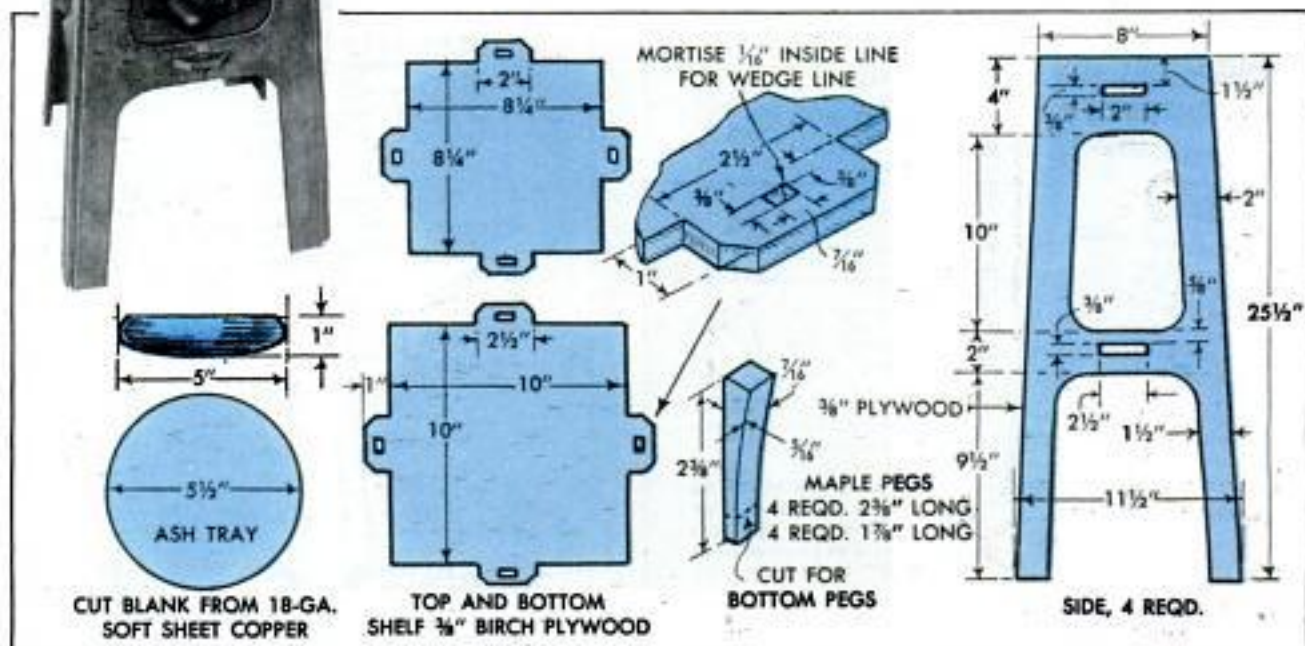
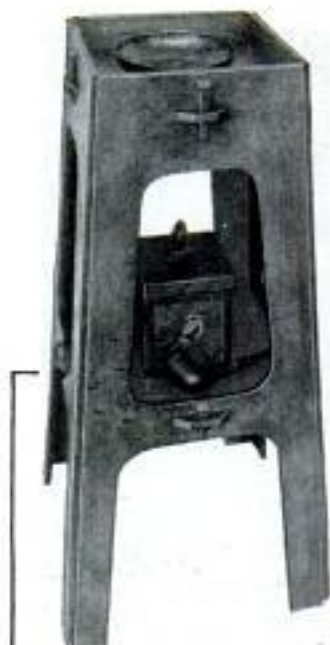

make it yourself with
**MASONITE
PRESWOOD**

Handy
"Sportsrobe"

Here's ample storage for sports equipment. It's easy to make with Masonite Preswood Products. Send coupon for plan and "Idea Book" showing around-the-home uses. 33 types and thicknesses of Preswood® are available from your building materials dealer.



NATURALLY STRONGER WITH LIGNIN

MASONITE®
CORPORATION

Dept. PM-10, Box 777, Chicago 90, Ill.

Please send me your "Idea Book." I enclose 10¢.

Name.....

Address.....

Town.....Zone.....

County.....State.....

"Masonite" signifies that Masonite Corporation is the source of the product

Darra-James
POWER TOOLS



Better
Than
Ever

8" and 9"
Tilt Arbor
SAWS

More For Your Money!

Better in every way... larger work tables... sturdier frames... newest mechanical improvements. Darra-James engineering department is constantly working to give you more for your money.

WRITE FOR CATALOGS

TOOLKRAFT CORP., SPRINGFIELD 1, MASS.



ADD STORAGE SPACE WITH THE NEW SIMPLEX stairway KIT!

SAVE MONEY!

ADD HUNDREDS OF FEET OF
ATTIC STORAGE

Give yourself extra storage room with the new SIMPLEX "Balanced Action" FOLDING STAIRWAY. It's easy to operate... fits any ceiling height from 7' to 9'9" and is rugged and strong. No. 1 kiln dried lumber throughout; all hardware fabricated of heavy steel; bolts and screws secure all parts (no nails); steps morticed into the runners for long life and safety.



SIMPLEX
Folding
Stairway
KIT



NEW!

**KIT COMES COMPLETE
WITH SIMPLE INSTRUCTIONS**

Easy to assemble with only a screwdriver and wrench. All parts in one package. All holes bored. Detailed instructions for assembling and installing included. Time required, only 45 minutes. Frame furnished and made to fit 26"x54" rough opening in ceiling. All parts interchangeable. Two standard sizes—for ceiling heights 7'0" to 8'3", order 8'3" size; for ceiling heights 8'3" to 9'9", order 9'9" size. (9'9" size \$25.00, F.O.B. Nashville).

Available at your
**LOCAL HARDWARE
DEALER'S**
See it NOW! Or
write for complete
information!

With detailed in-
structions for assem-
bling, installing.
ONLY \$24.00
F.O.B. NASHVILLE
8'3" SIZE

BUY YOURS NOW!

PRECISION PARTS CORPORATION

400-PM North First Street Nashville 7, Tenn.
DEALER INQUIRIES INVITED!

A DO-IT-YOURSELF CLOCK KIT



for installation in your own cabinet or room panel. Available in a finish of black, aluminum or brass. Comes complete with electrical movement, 4" center disc, hands, dots, markers or numerals. Only \$9.95.

Write for descriptive literature

Ultra-Craft Designs

Box No. 367
Grand Rapids 1, Mich.



"i need air"

Houses must breathe or
paint peels and wood rots.

All-aluminum "Midget"

Louvers allow proper
circulation through walls,
under eaves, roofs, floors.

You can install—drill holes,
push into place. Sizes 1"
through 6". At hardware,
paint, lumber dealers.

Write for complete data



MIDGET LOUVER CO.

8 WALL STREET, NORWALK, CONN.

OCTOBER 1954

For men who are planning to build
or remodel their own homes



You can install **TRUSCON** SERIES 138
DOUBLE-HUNG STEEL WINDOWS
YOURSELF!

FREE BOOK SHOWS YOU HOW.

Truscon makes it easy! New step-by-step guide shows you exactly how to install famous Truscon all-steel double-hung windows. Clear pictures and explanation are easy to follow. You see and learn the methods professionals use. Hammer, screw driver, and level are all the tools you need.



Installation is remarkably simple in either frame, brick veneer, masonry, or concrete block construction. You buy Truscon series 138 windows complete from your dealer. You choose from a wide range of sizes. All hardware is attached. Stainless steel weatherstripping and tape balances are built in. Screens and storm sash available. It's your greatest window bargain!

This free book may be worth hundreds of dollars in savings to you right now. Worth even more in terms of the comfort and convenience you and your family will enjoy for many years with your Truscon Double-Hung Steel Windows. Send coupon today!

Truscon Steel Division • Republic Steel
1126 Albert St., Youngstown 1, Ohio
Please rush free book showing me how to install
Truscon Double-Hung Steel Windows, series 138.



NAME _____

ADDRESS _____

CITY _____ ZONE _____ STATE _____

"Handy" SANDY asks:

WHY NOT DO IT THE EASY WAY?



... with these 3 work-savers



Flexbac® SANDING PAD

On your electric drill cuts sanding time in half. The soft rubber pad of the Flexbac Pad Assembly follows every contour—concave, convex or flat. You sand furniture, boats, woodwork, or anything made of wood, metal or plastic in half the time you'd take with ordinary sanding pads and hand sanding. Use RED-I-CUT® Waterproof Paper Discs or HANDY-SANDY Discs—just press 'em on, peel 'em off when done. Kit includes complete Flexbac Pad Assembly, adapter for 1/4" drill, adhesive restorer.



ONLY \$7 AT YOUR HARDWARE OR MARINE DEALER

Or direct, postpaid, with coupon below



FURNITURE REFINISHING KIT

Tells you how to do it—gives you the tools to do it with! 16-page instruction book gives you the step-by-step procedures... tells you how to get the most from the 22 cut sheets of professional sanding papers in the kit—including garnet, silicon carbide waterproof, aluminum oxide moulding cloth.

LESS THAN \$1 AT YOUR FAVORITE HARDWARE OR LUMBER YARD

Or \$1, postpaid, with coupon below



FREE ... 16-PAGE BOOK OF "GOOD SHORT-CUTS." Here are nearly all the "Good Short-Cuts" I've used in my column in *Popular Mechanics*, in a handy, pocket-sized booklet—completely indexed. Lots of valuable hints for the craftsman, or for the home "putterer." Pick up a copy at your hardware or lumber dealer; or send the coupon and I'll mail you one.

CLIP AND MAIL THIS TO ME

"Handy" SANDY

CARBORUNDUM

REGISTERED TRADE MARK

Niagara Falls, New York

I usually buy my hardware and tools from

Name of Store.....

Street..... City..... State.....

Send me a FLEXBAC® Pad Sanding Kit. Enclosed is \$7.

Send me..... Furniture Refinishing Kits. Enclosed is \$1 ea.

I'd like the FREE "GOOD SHORT-CUTS" booklet.

My Name.....

Street and Number.....

City..... Zone..... State.....

MENDING SHALLOW GOUGES IN FURNITURE

By Captain John M. Lietwiler, USN

CELLULOSE-FIBER wood fillers, which usually will not hold in shallow gouges in furniture, can be used successfully if mixed with powdered plastic-resin glue. First, undercut the edges and rough up the bottom of the gouge with a wood chisel. Next, put a quantity of filler into a container and gradually add small amounts of powdered glue until the filler becomes stiff, but not crumbly. Immediately work it into the gouge with a putty knife, building it up to 1/16 in. above the surface. Allow it to dry for 24 hrs., then sand flush and refinish.

1. Undercut edges and rough up the bottom of the gouge with a wood chisel so that filler will bond with raised fibers on bottom and lock into undercut when it is forced into the gouge with a putty knife

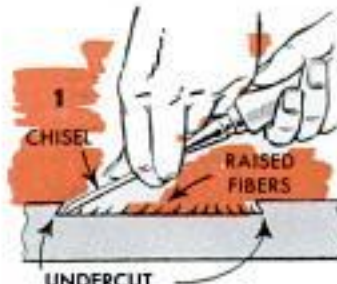

2. Place quantity of filler in container—about twice what is needed to fill gouge—and gradually mix in powdered plastic-resin glue until filler becomes stiff but not quite crumbly



3. Immediately force filler-glue mixture into gouge with putty knife. Add a small amount at a time, keying it into undercut and to the wood fibers in bottom. Build up filler to project above the surface

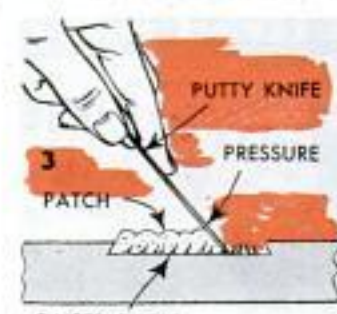

4. Final step is to allow filler to dry for at least 24 hours. Then carefully sand with perfectly flat hardwood block wrapped with fine sandpaper until patch is flush. Complete repair by matching the original finish



Build this space-saving sofa-storage unit

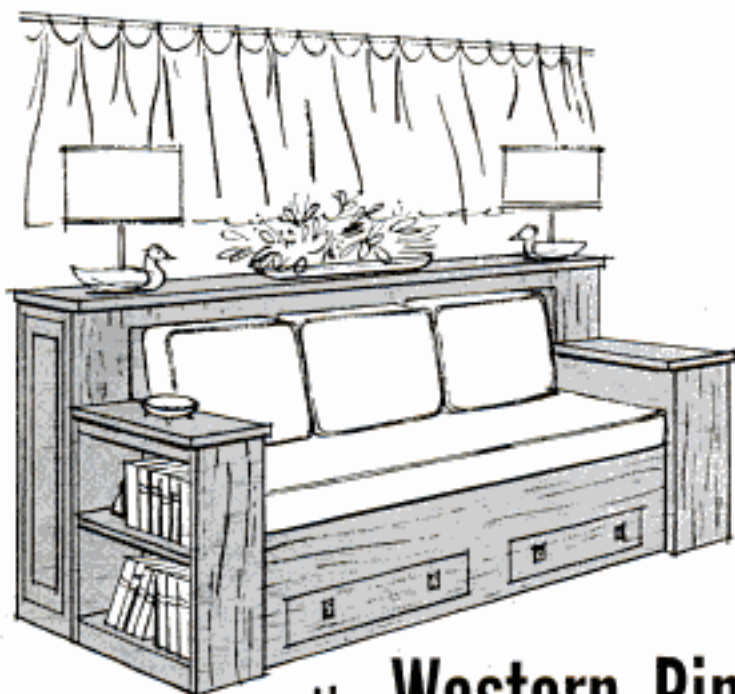

the Western Pines

- * IDAHO WHITE PINE
- * PONDEROSA PINE
- * SUGAR PINE

get complete detail drawings and easy-to-follow directions in

FREE PATTERN KIT 321

along with the picture-packed booklet "Friendly Home Ideas in Western Pine." Write for it to Western Pine Association, Dept. 321-N, Yeon Bldg., Portland 4, Oregon.

You'll find this attractive modern sofa ideal for guest room or country cottage. The mellow woods of the Western Pines* lend a handsome look to the sofa, cabinets, drawers and end bookcases. The framework is built for a box spring—which slides back to comfortable sitting width during the day.

You will find it costs little to build with the carefully selected, well-seasoned woods of the Western Pines. Soft-textured, easy to work, they take all finishes without grain-raising. See the Western Pine woods at your local lumber dealer—he'll be glad to give you an estimate!

Only **HOLD-E-ZEE** The Original AUTOMATIC GRIP **SCREWDRIVERS**

PROVIDE THESE FEATURES:

- **LOK-BLOK** that makes blade twist and impact proof.
- **GRIPPER** that snaps back—recedes deep into handle, giving full blade use.
- **HAND GROUND BITS**—chrome vanadium, chrome plated blades.

YET COST NO MORE THAN ORDINARY SCREWDRIVERS

UPSON BROS., INC., ROCHESTER 14 N. Y.



Pat'd.

At Leading Dealers
Everywhere!

SAW IT BETTER USE **ATKINS Silver Steel**



There's a type that's right
for every purse and purpose.

SEE YOUR HARDWARE DEALER

ATKINS SAW DIVISION

Borg-Warner Corporation, Indianapolis 9, Indiana



INSULATE NOW

for as **\$67.60**
low as cost for average attic

Do it Yourself in One Afternoon!



ZONOLITE®

VERMICULITE INSULATION

Easiest of all insulations to install . . . save as much as \$100 installation costs. Cuts fuel bills up to 40%. Fireproof, rotproof, permanent.

LIFETIME GUARANTEE!

Zonolite is guaranteed to last the lifetime of the building in which it is installed. No further maintenance is ever required.

Write for

FREE

How to Insulate
BOOKLET

Zonolite Company, Dept. PM-104
135 So. LaSalle St., Chicago 3, Ill.

Please rush your FREE Booklet, HI-20 with details on How to Insulate.

Name.....

Address.....

City.....Zone.....State.....

AT LUMBER OR BUILDING MATERIAL DEALERS

EASIEST, FASTEST
paint remover
you've ever used!



New, Improved
**Heavy Bodied
KLEAN-STRIP**



New semi-paste won't drip off overhead or upright surfaces. Peels any finish from any surface. Non-inflammable, safe to use. Needs no after-wash.

Sold by all Klean-Strip Dealers

THE KLEAN-STRIP CO., Inc.

2340 South Lauderdale • Memphis 6, Tenn.

NOW IT'S EASY TO MITER!
with the **BONZER**
MITER KING

a must for the "DO-IT-YOURSELF" home enthusiast!
and the professional carpenter, too!

The Bonzer "MITER-KING" is a scientifically designed carpenter's tool... which will do anything a conventional miter box will do... PLUS many extra advantages! Easily stored in a tool box... and using an ordinary hand saw... the Bonzer "MITER-KING" is light weight for easy handling.

PAT NO. 2547122



COMPLETELY SAFE!

No more knicked or cut fingers
saw-blade fits snugly INSIDE...
cuts evenly, smoothly... exact cut
every time!

EASY TO READ... degrees brightly
marked!

EASY TO ADJUST... turn wing-out
and move to degree desired!

1. Saw guide plate.
2. Window opening allows full view of cutting surface.
3. Hex head case hardened screw for proper alignment and tension.
4. Wing nut release for setting to any degree required.
5. Axial radius, die stamped zero to 50 degrees in right and left.

\$795



BONZER-WESTERN CORP.
3065 E. 12TH ST., LOS ANGELES 23, CALIF.

**Jig Permits Accurate Drilling
Of Narrow End Grain**



Keeping holes aligned when drilling the end grain of narrow stock is simplified by a drilling jig which consists of a length of mild-steel bar stock and a piece of 1/4-in. steel plate. The bar stock is drilled accurately in a drill press to provide several holes of different sizes. Then the steel plate is drilled to receive two screws which pass through corresponding holes drilled and tapped in the bar stock. The screws should be long enough to permit fitting shims between the plate and bar stock to accommodate various thicknesses of wood. The completed jig is clamped to the stock to be drilled.—Meyer Benjamin, Chicago.

**Install your own
HEATING SYSTEM**

Save up to
50%

**WRITE FOR THIS
CATALOG NOW!**



WRITE

PACKAGE COMFORT HEAT, Inc.
1425 Warrensville Center Road - Cleveland, Ohio

Simple, easy instructions furnished. Highest quality furnace and fittings — nothing else to buy. For new homes or old. Dealer franchises available. Purchase through leading building supply dealers.

FIRST AGAIN...

WITH NEW LOW PRICE

now only **\$33⁷⁵**

**NEW MODEL
"300"
Portable
Electric
Motor
Sander**



Makes hobby, production and maintenance sanding a breeze. The sturdy new, fine quality electric motor driven Model "300" is built to outlast and outperform more expensive sanders. Provides quick effortless sanding to a smooth "plane" finish on woods, metals, stone, plastics and composition. Has largest surface pad 4 1/2" x 7 1/2". Ball bearing construction, direct drive—no belts or gears to wear, light in weight. Accessories now available for paint removal, rubbing and polishing. See it at your tool dealer. "The sander used most extensively by rental services."

Other Electric Products

Model 200 Heavy Duty Sander . . . \$39.95

Model 505 Flexible Shaft Sander

JUNIOR TOOL COMPANY

Manufacturers of Electric Motor Specialties
975 W. First Street • Azusa, California



HAVE A BIGGER — MORE EFFICIENT HOME WORKSHOP

Popular Mechanics **PLANNING YOUR HOME WORKSHOP** shows you how to make use of every inch of space in your workshop: detailed floor plans, wiring layouts and power tool bookcase plus actual photographs of famous home workshops you can use as models. Save money by building your own shop furniture. Special Where-to-Buy-It Guide. 450 Illustrations. Cloth Bound. Working Diagrams. Order your copy today from

\$2.50

POPULAR MECHANICS PRESS
200 E. Ontario Street Chicago 11

**CUT THE BOLT YOU NEED
TO ANY LENGTH**

**HEAT AND BEND
TO ANY SHAPE**

24" and
36" lengths

7 SIZES

1/4" 3/16" 3/8" 7/16"
1/2" 5/8" 3/4"

REDI-BOLT

THREADED STEEL RODS

Ask Your Hardware Dealer or Write

REDI-BOLT, Inc., 5330 Indianapolis Blvd., East Chicago, Ind.

**HOW TO ADD
ANOTHER ROOM**



This free
book makes
it easy...



It's a cinch to build an extra room in wasted attic space. This book shows you how to put up frames and partitions, how to trim and paint. And how to keep your home warmer in the winter, cooler in the summer with Fiberglas* Insulation. Extra efficient, sanitary Fiberglas Insulation is easy to handle . . . lasts for the life of the house. Get started soon, write for free book today!

OWENS-CORNING

FIBERGLAS

Owens-Corning Fiberglas Corporation
Dept. 178-J
Toledo 1, Ohio

Please rush a copy of the "How-To-Do-It-Yourself" book to:

NAME _____

STREET _____

CITY _____ ZONE _____ STATE _____

*Fiberglas is the trade-mark (Reg. U. S. Pat. Off.) of Owens-Corning Fiberglas Corporation.



ZIP!
and old paint
strips off easily

No more hard work removing paint, varnish, lacquer and enamel — when you use Wonder-Paste. This remover is *different* — thoroughly softens up old finishes so they come off easily — not coat by coat, but all in one scraping. Wonderful indoors or out...for floors, trim, furniture — any finished surface. It stays moist so you can work on larger areas, and clings to upright surfaces. Harmless to wood, metal, fabric and hands. At paint and hardware stores.



WONDER-PASTE

Write us for leaflet and advice on your removing problem.

Wilson-Imperial Co., 119 Chestnut St., Newark 5, N.J.

Over 4 million cans sold — it must be good!



New!
Pella[®]
WOOD
FOLDING
DOORS

Decorative • Convenient • Economical

Now you can use the floor and wall space that swinging doors waste. Pella Wood Folding Doors fold compactly against the door jamb like an accordion. Ideal for closets, bedrooms, kitchen . . . and as folding partition between living and dining rooms. Anyone can install, quickly, easily. Completely packaged with hardware, fittings, installation instructions. Heights to 10', widths to 30'. Natural wood finishes and unfinished. Investigate today!

CLIP AND MAIL TODAY

ROLSCREEN COMPANY
Dept. F-111, Pella, Iowa

Please send complete literature on Pella Wood Folding Doors.

NAME _____

ADDRESS _____

CITY _____ ZONE _____ STATE _____

Combination SHELF-SERVING TRAY

By Carlton Strickland

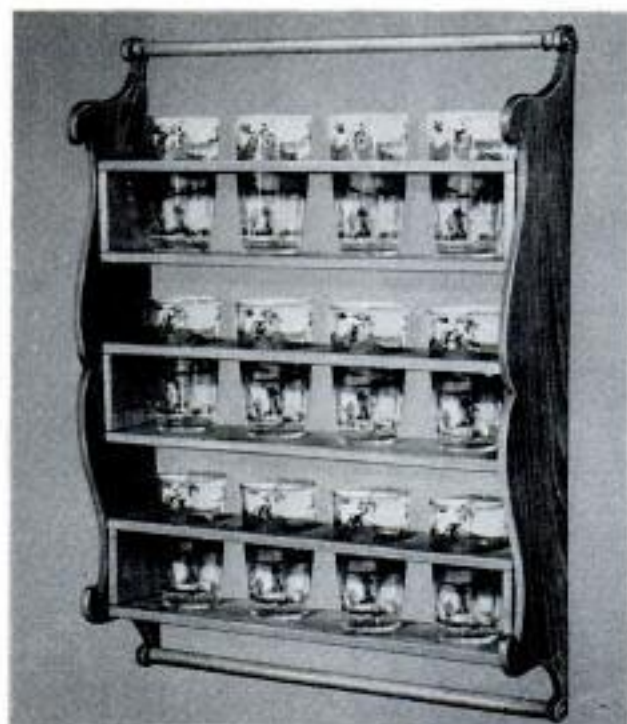

THE PROBLEM of storing large tumblers is solved and an especially handy serving tray is obtained by making this shelf-tray combination. When used as a shelf, the unit with the glasses in place is hung from a wall, thus providing an attractive accessory. When the unit is turned horizontally for use as a serving tray the tumblers remain upright in their pivoted racks.

Although the original tray was made from knotty pine dressed to a $\frac{3}{8}$ -in. thickness, almost any kind of lumber, including packing-crate material, could be used. The two handles are lengths of $\frac{5}{8}$ -in. dowel.

Begin making the shelf by cutting out the two sides according to the half pattern. Locate and drill the holes for the pivots and install the dowel handles. Then cut out the parts for the three tumbler racks. Holes

(Continued to page 328)

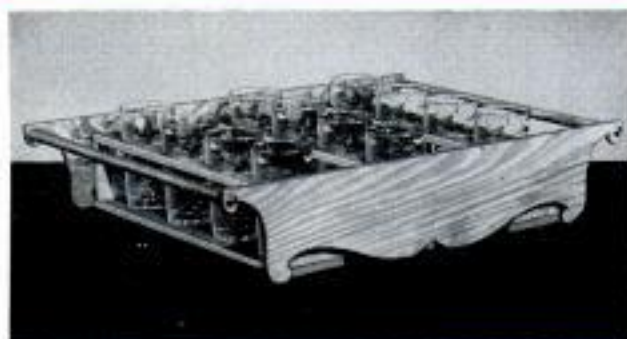

NAIL THIS WEATHERSTRIP on the bottom of your overhead-type garage door

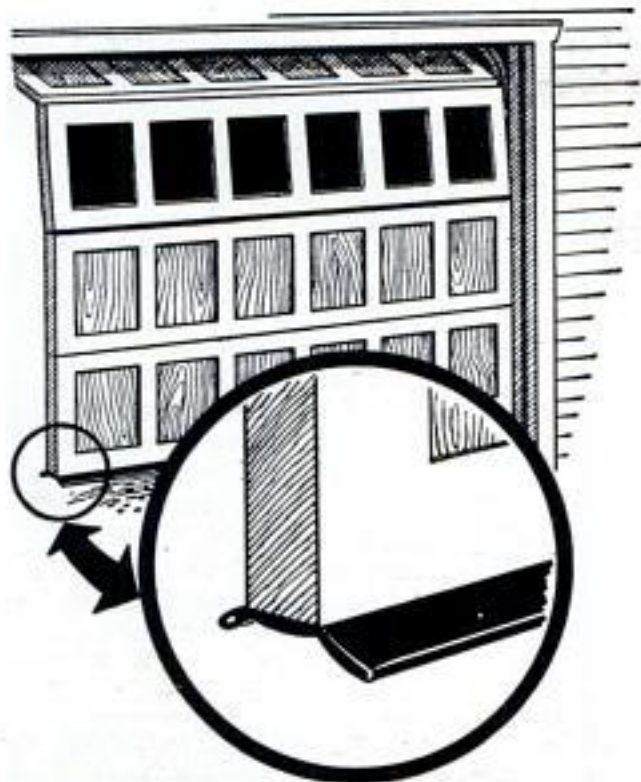

StanStrip* is a durable, live-rubber weatherstrip, easily installed by nailing to the bottom of your present overhead-type garage door. Proved effective for years on thousands of garages. Or if your plans include a new garage, ask the builder to install StanStrip. *Trademark

overhead-type garage door

- Seals out rain, snow, dust and drafts.
- Seals in heat. Pays for itself quickly.
- Cushions door closing.
- Protects door bottom against rotting.
- Prevents splintering and glass breakage!



SOLD IN LEADING HARDWARE STORES EVERYWHERE. If unavailable, use coupon below. Postage prepaid with check or money order. Sorry, no c.o.d.'s.

THE STANDARD PRODUCTS CO.
Dept. "M", Box 1092, Cleveland 2, Ohio

Enclosed is \$ _____ for StanStrip as checked below.
 8 Ft. \$2.95 9 Ft. \$3.29 16 Ft. \$5.90
 (Other lengths to 20 Ft., 37¢ per Ft.)

Name _____

Address _____

City & State _____

ARROW GUN TACKER

THE MODERN NAILING METHOD

for **1001**
DO-IT-YOURSELF
NAILING JOBS



5 TIMES
FASTER
THAN
HAMMER
& NAILS!

Now! Breeze through nailing jobs with almost effortless ease! Automatic, one-hand operation does it faster, cheaper and better! 100 staples cost only 5¢! Ideal for applying ceiling tile, insulation, upholstering, screening, cornices, wire fencing, etc. Ask for demonstration at your local hardware or building material dealer. Write for FREE Do-It-Yourself brochure.

ARROW FASTENER CO., INC.
DEPT. PM, ONE JUNIUS STREET
BROOKLYN 12, NEW YORK

It's Easier to DO IT YOURSELF

with **STOUX** QUALITY ELECTRIC TOOLS

1/4" ELECTRIC DRILL

- Small design • Full Powered
 - Light weight • Permanently Lubricated • Pistol Grip
- No. RC-1885—\$22.95



COMPLETE DRILL TOOL SET

Includes 1/4" drill and accessories for drilling, grinding, wire brushing, polishing, cleaning, etc.

No. RC-1822—\$39.75

ORBITAL ACTION FLAT SANDER

Working at 4,000 cycles per minute produces finest finish on wood, metal, fibre—anywhere hand sanding is usually employed.

No. RC-1850—\$45.80



HEAVY DUTY ELECTRIC SAW

Saw through 2x4's at a 45° angle with more blade to spare than with most 6" saws . . . that means more sharpenings, longer use from each blade! Modern, rugged, powerful!

No. RC-1806—\$74.50

THE TOOLS THE PROFESSIONALS
HAVE USED FOR OVER 40 YEARS.

Write for NEW Catalog!



ALBERTSON & CO., INC.
SIOUX CITY, IOWA.



PREPO the torch that does it all!

• Here's the hottest, handiest, lightest hand torch ever... with six interchangeable burners and tips from which to choose. Instant flame! Instant heat! Uses low-cost Prepo Fuel in the convenient throw-away tank. Each tank lasts for hours of continuous full-flame use.

\$6.45

Price includes torch as shown. Other burners and tips at slight additional cost. Prepo Fuel tanks 79c.

PREPO CORPORATION
EDGERTON, WISCONSIN



You CAN PAINT THE THOMAS WAY...AND SAVE!

"I help my husband with *all* the painting. It's *easy* with a Thomas Paint Roller! You can save time and money, too, by painting your walls, ceilings, floors, fences, boats, farm buildings — with a THOMAS roller."



... BE SURE YOU GET THOMAS... of your paint, hardware, lumber dealer.

THOMAS PRODUCTS COMPANY
8490 Lyndon Ave. • Detroit 21, Michigan

(Continued from page 326)

for four tumblers are cut in the top section of each rack. The 2 $\frac{3}{4}$ -in.-dia. shown is about right for the typical 10-oz. tumbler. However, check the diameters of the tumblers to be used and cut the holes large enough to permit the tumblers to rest on the bottom of the rack but also hold them steady. Then the end sections of each rack are cut to size, drilled for the pivoting screws and fastened between the top and bottom sections with glue and brads.

Install the racks in the jigsawed frame with oval-headed screws and washers as shown in the upper right-hand detail below. Use a flat steel washer between the rack and the shelf side and a cup washer on the inside of the rack. The racks should swing freely on the pivot screws.

Paint or stain the shelf-tray or finish it natural. It's best, of course, to sand all the parts thoroughly and finish them before final assembly. ★★★

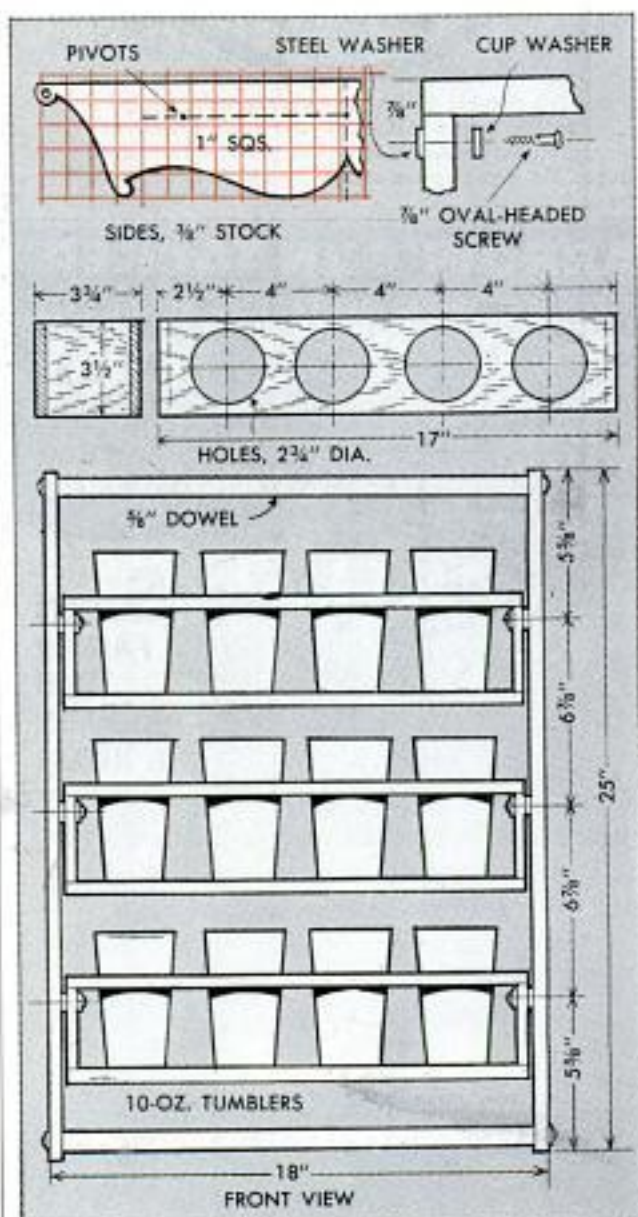

WHAT'S YOUR DO-IT-YOURSELF TOOL I.Q.?

Try this quick quiz! It's fun! See how high you can score!



No. 41

True False

Cutters on some pliers are so keen and accurate they snip bond paper clean as scissors!



No. 259-P

True False

Cutters on some pliers are so tough they're tested to 100,000 cuttings of tempered steel plow wire .080" diameter.



No. 50

True False

Jaw surfaces of some cutting pliers are "armored"—extra hardened by electronic induction to resist nicks, so last far longer.



No. 507

True False

Some pliers are tested by applying 150 lbs. pressure on handles. They must pass this test before shipment.



No. 91

True False

A maker of adjustable wrenches extra hardens the jaw surfaces to resist burring. Last ten times longer than ordinary wrenches.



No. 92™

True False

A new wrench is adjustable... can be locked tight at any jaw opening... and can be used as a small vise, also.

ANSWERS: When you buy UTICA® pliers and adjustable wrenches, every single question above can be answered "TRUE"! These are the kind of top quality tools that help you "Do-It-Yourself" easier and quicker. If you like to DO-IT-YOURSELF, you should have our catalog of UTICA TOOLS®. Send for it today. UTICA does not sell direct from the factory, but your tool dealer has them or can get them for you. Insist on UTICA for the advantages above.



DROP FORGE & TOOL CORP.
Utica 4, N. Y.

HELPFUL BOOKS

Send post card asking for FREE catalog

Popular Mechanics Press, 200 E. Ontario, Dept. 601, Chicago 11

OPERATE YOUR THOUSANDS OF SPEEDS!

STANDARD CUB VARIABLE SPEED TRANSMISSIONS!

... increase machine output up to 40%! Fits any machine using "A" belts and motors in any garage. Has speed range of 3:1:1. Get thousands of speeds without stopping machine. Automatic, positive belt alignment — no vibration. Highest quality, precision ball bearings — machined cast iron construction. Thousands in use throughout industry. **\$18.50**

• Order from post dealer or mail check direct! ONLY POSTPAID
STANDARD TRANSMISSION EQUIPMENT CO.
70 WEST UNION STREET • PARADISE 1, CALIFORNIA



Big New 24-Page profusely Illustrated DO-IT-YOURSELF PROJECTS BOOK



Describe attic finishing, built-in cabinets, add a room, recreation room, kitchen remodeling, summer cottage and farm projects! Contains helpful information on how to get started, planning, cost estimating, materials purchasing, and proper procedure. Also nail charts, moulding designs, etc. Send only 25¢ and also receive FREE 32 PAGE POWER TOOL CATALOG.

BOICE-CRANE COMPANY
943 Central Ave., Toledo 6, Ohio

Build Your "Dream Porch"

Now, you can do-it-yourself with low-cost SUN-SASH Louvred Windows. They fit any size opening and are installed easily, inexpensively in a matter of minutes. You'll have a cool porch in summer; an extra room for winter use. Send for our free booklet, "Louvred Window Ideas" illustrating over 50 ways to use SUN-SASH for every room in your home.

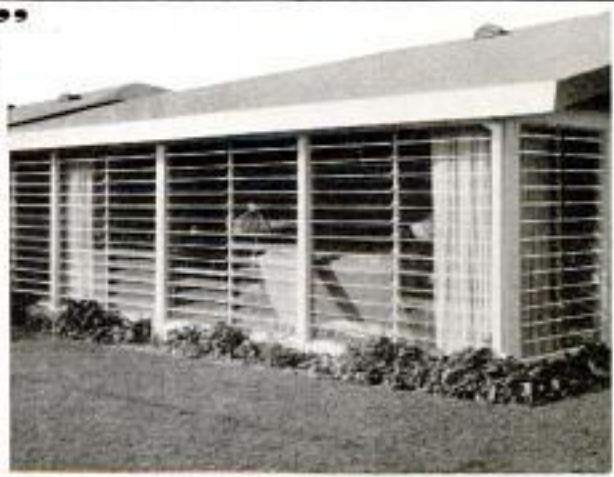

Mail Coupon Today!

SUN-SASH Company, Dept. PM-3
38 PARK ROW, NEW YORK 38, N. Y.

Name.....
Address.....
City.....State.....

MOTOR TIPS

for the Handyman

This **FREE**
motor guide
tells how to . . .

- Choose the **RIGHT** motor for any application.
- Select proper accessories and pulleys.
- Make your motor portable to handle a 1001 jobs.
- Make your motor last longer—**with** minimum care.



REMODELING—for better living all the family will appreciate.



REPAIRS—Dad wants to enjoy making while he saves money.



NEW FURNITURE—Mom wants to beautify and dress up her home.



JUVENILE FURNITURE—that spells play fun for Junior and Sis.

Versatile Westinghouse Handy-Craft® motors make all these projects easy—more fun. Your Handy-Craft dealer displays the decal at right. See him for a motor guide, or use coupon below.



J-21855

YOU CAN BE **SURE**...IF IT'S
Westinghouse



WESTINGHOUSE ELECTRIC CORPORATION
Handy-Craft Motors, P. O. Box 5151, Cleveland 1, Ohio
Please send me a copy of your **FREE** Handy-Craft motor guide.

I would like complete drawings and instructions for constructing the Handy-Crafter coffee table.

Name _____
Address _____
City _____ Zone _____ State _____

PM 10-54

BASIC HAND TOOLS

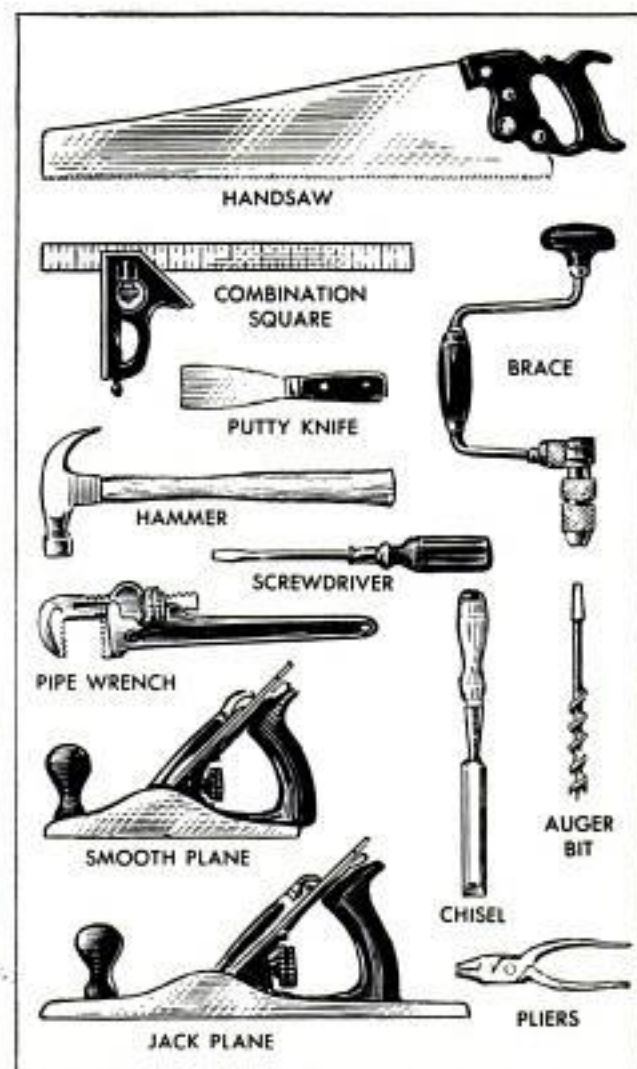

1 Hammer	16 oz.	1 Vise	Jaws 2½ in.
1 Folding Rule	4 ft.	1 Pipe Wrench	10 in.
1 Boxwood Rule	2 ft.	1 Bench Plane	9½ in.
3 Screw Drivers	4 in., 5 in., 6 in.	1 Block Plane	6½ in.
1 Screw Driver	1½ in.	4 Chisels	¾ in., 1½ in., ¾ in., 1 in.
1 Hand Saw	24 in.	1 Try and Miter Square	12 in.
1 Pair Pliers	6 in.	1 Level	18 in.
1 Brad Awl		1 Mill File	8 in.
1 Hand Ax	19 in.	1 Slim Taper File	6 in.
1 Bit Brace	10 in.	1 Putty Knife	
6 Auger Bits,	¼ in., ¾ in., 1 in., 1½ in., ¾ in., ¾ in., 1 in.		

FOR SIMPLE JOBS around the home, such as repairing a faucet, fitting doors, making shelves or simple storage cabinets you will need the basic, or primary, hand tools. The 12 tools pictured above are a good first selection but you may want to substitute a block plane for the jack plane or you may see the need of a full set of chisels and auger bits. All tool selections are flexible. The table above lists a more complete selection with which you can handle quite complicated projects, especially in woodworking. Of course, you will want to add to the original list until the selection for your purpose is complete.

POPULAR MECHANICS

MILL IT... ON YOUR LATHE!

PALMGREN

MILLING ATTACHMENT

3 SIZES

No. 250 Illustrated

2 1/2" JAW Only

24/75

CONVERT LATHE IN 10 SECONDS



Now you can Mill, Slot, Grind, Groove, Square Shafts, Saw at Angles, Recess and many other important jobs. SAVE TIME and MONEY! Why send work out or use costly methods when a PALMGREN MILLING ATTACHMENT will solve your problem.

Precision built, it has accurate graduations for rotary angle adjustments, also graduated vertical feed screw. Fits South Bend, Atlas, Craftsman, Logan, Sheldon and all other lathes. Thousands now in use in small and large machine shops, repair shops, railroads, schools, home work shops, etc. ORDER SIZE NEEDED TODAY!—it will quickly pay for itself.

IMMEDIATE DELIVERY

Nos.	Width Jaws	Depth Jaws	Jaws Open	Weight Pounds	Fits Tool Post	Price F.O.B. Factory
150	1 1/2"	1"	1 1/2"	6 1/2	1" Dia.	\$18.75
250	2 1/2"	1-7/16"	2 1/2"	11	1 1/4" Dia.	24.75
400	4"	1 1/2"	4"	25	2" Dia.	39.75

Order From Your Dealer or Jobber: Write for Circular No. 202
Mfrs. of PALMGREN PRODUCTS Since 1915

CHICAGO TOOL and ENGINEERING CO.

8365 South Chicago Ave. Chicago 17, Ill.

JUST A FEW OPERATIONS YOU CAN DO ON YOUR LATHE!

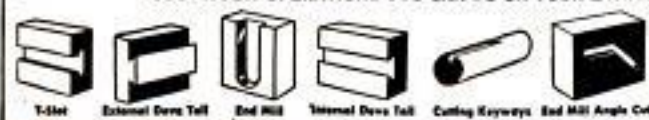

Paint outside trim the fast, neat way...



Pointers on painting: remove shutters to avoid splattering house; lay on crates or sawhorses. Make sure surface is clean and dry. Do back first. Start with hard-to-get-at areas. To paint door frame, start at the top and work down. And always...

Use brushes with bristles of Du Pont **TYNEX** nylon

You make easy work...tidy work...of any paint job outdoors or in when you use brushes with bristles of Du Pont "Tynex" nylon.

"Tynex" bristles carry a full load of paint... flow on a satin-smooth coat. They can be quickly cleaned afterwards with any commercial cleaner.

"Tynex" bristles don't get brittle... last up to 5 times longer than other bristles. When buying any type brush, "Tynex" is your guide to quality.

For free booklet "How to Choose and Use a Paintbrush Bristled with Du Pont 'Tynex' Nylon," write Du Pont Polychemicals Dept. PM-10, Wilmington 98, Del.

*"Tynex" is the trade-mark for genuine Du Pont nylon bristles

Look for **TYNEX** nylon bristles when you buy brushes



DU PONT

Better Things for Better Living... through Chemistry

"DO IT YOURSELF" IT'S EASY WITH **KESTER SOLDER**



Soldering's really a "cinch"... when you use time-tested, reliable KESTER... available everywhere.

FREE! "Soldering Simplified"... 16-page how-to-solder booklet. At your dealer or write direct.

KESTER SOLDER COMPANY

4251 Wrightwood Avenue Chicago 39, Illinois

do it faster...better!



PLIERS, CHISELS, PUNCHES, SNIPS, ADJUSTABLE WRENCHES

Buy wherever fine tools are sold in U. S. and Canada.

KRAEUTER

ANY 3 OF THESE

39 PLANS
FREE*

FOR DO-IT-YOURSELF PROJECTS YOU
CAN MAKE WITH **FIR PLYWOOD**



CHRISTMAS DECORATIONS

No. 1 includes plans for: Giant Santas
• Angel & Choir Boys • Carolers • Christmas Tree
• Sleigh & Reindeer • Others



CHRISTMAS GIFTS & TOYS

No. 2 includes plans for: Child's Desk • Toy
Trailer • Doll House • TV Table • Cutting Board
• Knife Rack • Take-apart Play Planks • Others



NATIVITY SCENE

No. 3 includes plans for life-size cut-out
figures for striking Manger display



12 plans for KITCHEN FEATURES

4. Snack Bar 5. Snack Bar Overhead Cabinet
6. Cleaning Cart 7. Built-in Range Cabinet
8. Built-in Range Drawers 9. Laundry Cart
10. Canned Goods Closet 11. Kitchen Desk
12. Sink Cabinet 13. Mixing Center Counter
14. Sliding Spice Rack 15. Oven Utensil Cabinet



8 plans for BUILT-INS

16. Living Room Storage Wall 17. Sectional
Storage Wall 18. Attic Storage Wall 19. Child's
Storage Wall 20. Music Wall 21. Odds 'n Ends
Cabinet 22. Shelf Door Wardrobe 23. Entry Closet



5 plans for FURNITURE

24. Buffet Chest 25. Stacking Cabinets
26. Storage Bed Headboard 27. Toy Storage
Blocks 28. Workshop Bench



5 plans for OUTDOOR STORAGE

29. Patio Furniture 30. Child's Playhouse
31. Child's Sand Box 32. Garden Work Center
33. Outdoor Storage Wall



6 plans for BOATS

34. 8' Pram 35. 9' Skiff 36. 11½' Skiff
37. 13½' Outboard 38. 15' Sailboat 39. 20' Sloop

* Up to 3 plans free; send 10c for each additional 3 plans.
Order by plan number from Douglas Fir Plywood Association,
Dept. P-2, Tacoma, Washington.

Plywood Sheet Held Rigid By Straightedge Clamp

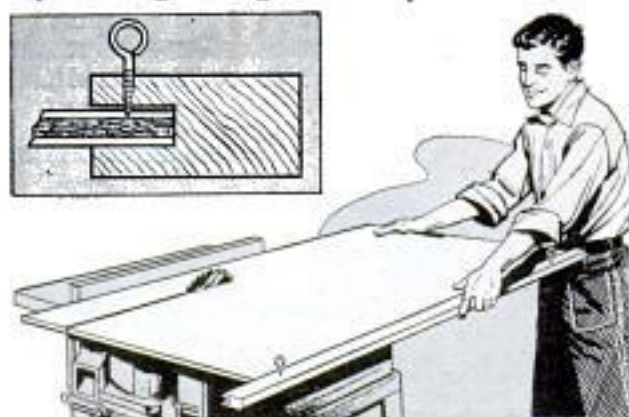
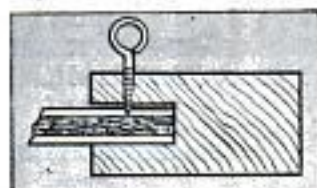

A grooved straightedge, clamped to the edge of a sheet of thin hardboard or plywood, will prevent dangerous flexing when it is being cut on a circular saw. A strip of 2-in. stock, the length of the sheet of plywood, is grooved about 1½ in. deep and slightly wider than the thickness of the sheet. Screw eyes are inserted in the strip and tightened against the plywood sheet.

Attractive Wiener Forks Shaped From Brass Rod

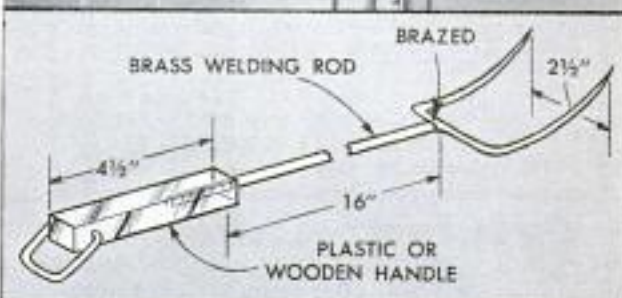

Made of rustproof brass and fitted with heat-resistant handles, the wiener forks shown in the illustration can be used at either indoor or outdoor fireplaces. The tines of the forks can be sharpened more easily before they are bent to shape and brazed to the shaft. The handles, made of plastic or wood, may be fitted with metal loops, as shown in the photograph, to permit hanging them beside the fireplace.

Glenn S. Hensley, Stanberry, Mo.

New Formula Zips Off Paint!

X-CELL-ALL

No-Wash Remover
with
Dow Methylene Chloride

Remove old paint, varnish, lacquer, shellac with amazing X-CELL-ALL. Safe—won't burn! Start repainting as soon as old paint is off. Won't harm woods. At paint and hardware stores. Or send check for \$4.25 gallon, \$1.25 quart. Shipped postpaid. No C.O.D.'s.



Write Dept. 33

Luminall Paints
CHICAGO 9, ILL.

HELPFUL BOOKS

Send post card asking for **FREE** catalog

Popular Mechanics Press, 200 E. Ontario, Dept. 601, Chicago 11

**FOR HINGES THAT SQUEAK
AND SWITCHES THAT STICK
MECHANICS USE LUBRIPLATE
IT'S CLEAN AND IT'S QUICK**



TRY LUBRIPLATE! It's a new, white and clean, semi-fluid lubricant that stays put. Stops squeaks, prevents rust and corrosion. Works wonders on your car and around your home.

- In handy 35¢ and 95¢ tubes at hardware and auto supply stores.
- Dealers write to LUBRIPLATE DIVISION, Fiske Bros. Refining Co., Newark 5, N.J.

LUBRIPLATE
THE MODERN LUBRICANT

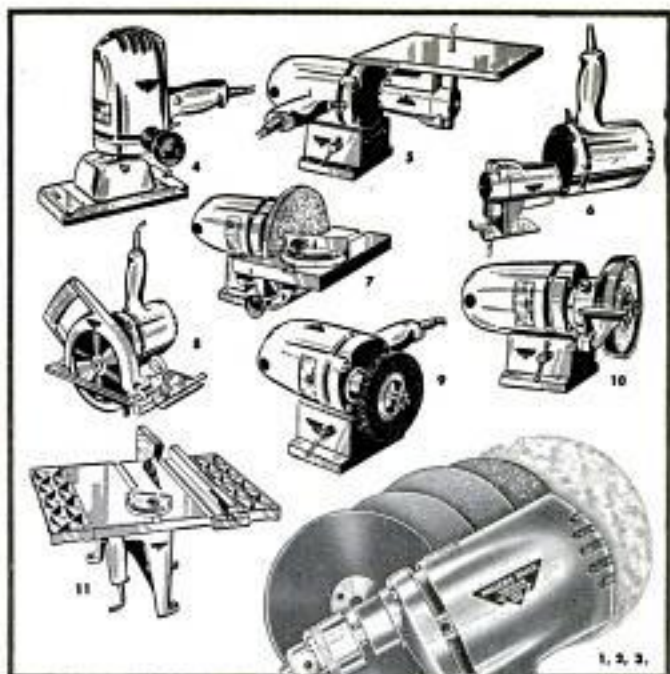

**New
Millers Falls
DYNO-MITE**

POWER WORKSHOP

Now—at only a fraction of what it would cost for individually powered tools—you can start and build up a complete portable electric power workshop.

First, you get the rugged new Millers Falls Basic 888 Power Unit (1, 2, 3 above). Rated at a full 1/2 h.p., it costs only \$39.95 and comes completely equipped as 1) a 3/8" Drill—2) a 6" Disc Sander—and 3) a 6" Polisher. Then—with beautifully engineered, inexpensive attachments—you can convert your 888 Power Unit into 8 additional tools: 4) No. 882 Orbital Sanding Attachment, \$15.50—5) No. 887 Jig Saw Table (also requires No. 881 Stand and No. 886 Jig Saw Attachment—see below), \$1.75—6) No. 886 Jig Saw Attachment, \$9.95—7) No. 889 6" Bench Disc Sander (also requires No. 881 Stand), \$7.95—8) No. 8811 6" Portable Circular Saw, \$15.95—9) No. 881 Bench Stand, \$2.95—10) No. 8810 4" Bench Grinder (also requires No. 881 Stand), \$5.95—and 11) No. 883 6" Bench Saw, \$22.95.

Ask your dealer to show you these remarkable new tools. Ask him, too, for **FREE** catalog, or write direct:

**MILLERS FALLS
COMPANY**

Dept. PM-4a,
Greenfield, Mass.



Finest Power Tools Made

A New Workshop Idea!

5 full size **1** motor runs
power tools them all!

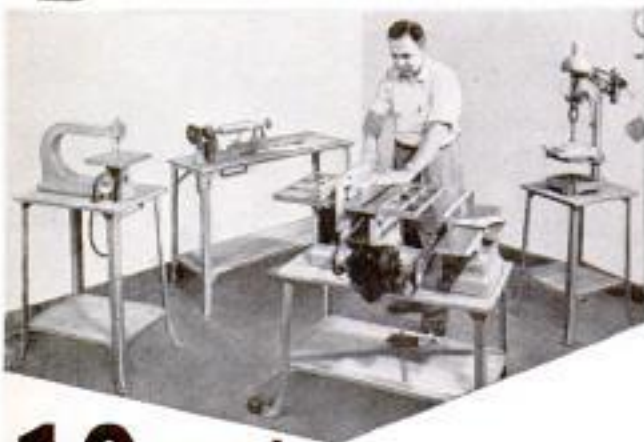

10 second
motor changeover!

Think of it, 5 full size, professional quality, individual power tools—all operated from one motor and priced at only \$239.95 (less motor and stands). The secret of this revolutionary power tool idea lies in an exclusive Duro development—the “quick change” motor mount. It permits you to bring the motor to each tool—quickly, easily—in a matter of seconds! You can now do wood-working the correct, safe way, at convenient heights, without interference from other tools. All units remain pre-set for immediate operation. There's no need for repeated knocking down and setting up, making adjustments, changing guides, attachments and cumbersome tool positioning.

Build Your Shop A Unit At A Time

The Duro Master workshop can be started with any single unit or combination of units to suit your need and budget. You buy only what you need when you need it. You can begin your workshop with a drill press, sander, circular saw, jig saw, or any combination of tools. Each unit can be equipped with the “quick change” motor mount and is operated with same motor.

Send for **FREE 16 Page Catalog** giving full details, specifications and prices on the **DURO MASTER WORKSHOP**.



DURO METAL PRODUCTS CO.

2661 N. Kildare Avenue • Chicago 39, Ill.

Gentlemen: Please rush me your **FREE 16 page** booklet on the new **DURO MASTER WORKSHOP**.

Name.....

Address.....

City and State.....

My dealer is:.....



TELEPHONE SHELF

If finding a convenient place for your telephone and directories is a problem, this telephone shelf is the answer. It is made from ½-in. stock, following the patterns below. For a fine job, hardwood can be used, or the shelf can be made from pine and then stained. A memo-pad rack completes the shelf

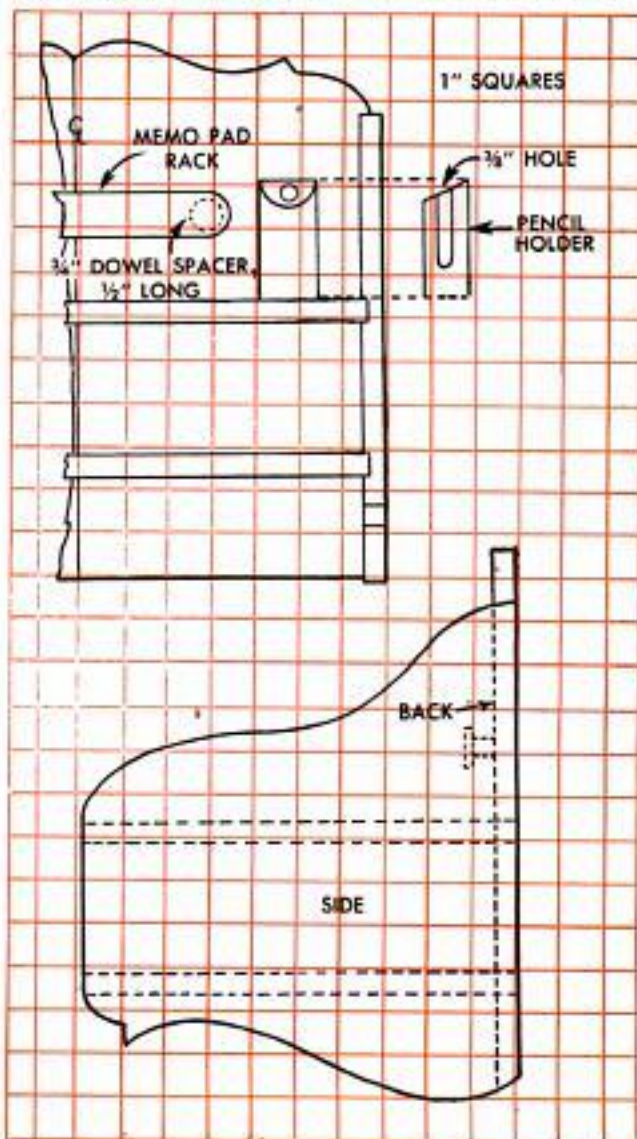



SPEEDY RIVETS

simply swat
with a hammer

Fasten leather, cloth, paper, plastics. Quick, secure, permanent repairs . . . ideal for craftwork, too. Simply make a hole in each part to be fastened, push rivet together through holes, place on firm surface and swat with a hammer. Gilt, nickel, black, brown finishes. Large (6 per card) or small (10 per card) sizes.

AT HARDWARE
COUNTERS
EVERYWHERE

15¢
per card



THE DOT LINE

3229 S. Ashland Ave., Chicago 8, Ill.



You don't have to
"do-it-yourself"



Beautiful
"Scratch-Test" finish
will not crack,
chip or peel

Bruce Oak Flooring is already sanded and finished!

ALL YOU DO IS NAIL IT DOWN

Give your home the new beauty of modern oak floors this easy way. Just nail a Bruce *Prefinished* Floor over your old floor or wood subfloor. No mess of sanding or finishing. Ready for use as soon as it's laid. Choose from Block, Strip or Ranch Plank designs.



It's economical! A new Bruce *Prefinished* Floor will cost you less than a good rug or carpet . . . and you'll always be proud of its smart, modern style. Install this modern hardwood floor yourself when you add a room or fix up your attic. The factory finish makes it easy to keep clean and new looking. Ask your lumber dealer for an estimate. Mail coupon below for colorful literature.

MAIL FOR FREE LITERATURE



E. L. Bruce Co.
Box 397-Q, Memphis 1, Tenn.

Send me complete information on
Bruce Prefinished Oak Floors.

Name _____

Address _____

Bruce PREFINISHED Oak Floors

By the world's largest hardwood flooring maker



Pays for Itself 100 Times Over

Beat the high cost of home upkeep. Save hundreds of dollars every year on carpentry, electrical, painting, plumbing and other jobs around the house with *Popular Mechanics GUIDE TO HOME REPAIRS*. Simplified how-to-do-it instruction and 4-40 pictures make all jobs, inside and out, easy. Covers construction, remodeling, modernizing, repairing that you can do yourself at small cost. 192 page cloth bound book only \$2.50 postpaid. Order today under our money back guarantee.

POPULAR MECHANICS PRESS, Dept. PM16
200 EAST ONTARIO STREET CHICAGO 11, ILLINOIS



CARLSON

Super Chief

16 FEET LONG
3/4" WIDE
WHITE BLADE

for one-man measuring
Here's big news—in a compact, pocket-size package. The all-new Carlson SUPER CHIEF Steel Tape Rule has 16 feet of wider, more rigid steel blade—designed into a pocket-fitting 2 1/2" case that weighs only 6 1/4 oz. Best of all . . . with the SUPER CHIEF, you alone can now make accurate extended vertical and horizontal measurements quicker . . . easier.

Handy Re-wind Crank moves the 16 ft. blade smoothly in and out of case, without backlash.

Easy-to-Read—jet black numerals on snow-white blade won't surface crack or peel.

Quick Blade-Change—Patented Swing-Tip

Do-It-Along—and do it better—with a Carlson SUPER CHIEF. See it at your Hardware Dealer!

Carlson & Sullivan, Inc.
MONROVIA, CALIFORNIA

Produced under Patents #2089209, #2510939, #2629180 & Pat. Pend.

DID YOU KNOW THERE ARE 4 DIFFERENT SANDING ACTIONS?

... BUT ONLY STRAIGHT-LINE ACTION
WILL PRODUCE A FLAWLESS,
SCRATCH-FREE FINISH



When choosing a power sander—it's the type of action that counts. To do the job right, you must sand with-the-grain. Sanding across-the-grain with a circular or orbital motion leaves scratches and swirl marks which show up after varnishing. Always remember — only a Dremel STRAIGHT-LINE ACTION will sand with-the-grain. Take a tip from the professional craftsman, insist on a Dremel—3 popular models to choose from.

Of the four common sanding actions, only Dremel sands 100% with-the-grain — the only guaranteed scratch-free action approved by finishing experts.

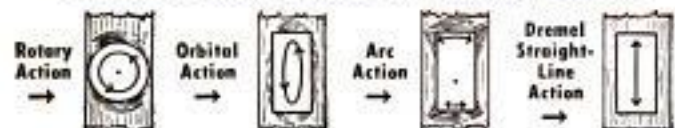

NEW MODEL "53"

This new sander is a real powerhouse, a professional tool at a handyman's price. The first ROTARY MOTOR (A.C.) sander of its kind to have straight line action. Weighs only 5 1/4 lbs., has 24 sq. in. sanding pad. Out-performs other makes selling for twice as much. Positively the best heavy-duty sander buy on the market. Complete with 2 detachable sanding pads. . . .



\$34.85

EXCLUSIVE! Model "53" has a quick-action detachable sanding pad. Extra pad furnished free.



Model "2000" Sander-Polisher

Perfect for small shop, home use. Features Dremel "Straight-Line Action"; high speed reciprocating motor; 14,400 strokes per min.; wt. 5 lb.; 21 sq. in. sanding surface.

Price includes: Sturdy, steel carrying case, Model "2000" Sander-Polisher, 1 polish pad, 25 asst'd abrasives. . . .

\$24.50

Model "A" Sander-Polisher-Massager

Three tools in one! Lighter capacity for general-purpose use. Features "Straight-Line Action"; high speed reciprocating motor; Wt. 2 1/2 lbs.; 12 sq. in. sanding surface. Complete with 1 polish pad, 1 massage pad, 6 abrasives. . . .

\$14.85



SEND FOR FREE CATALOG

SEE YOUR DEALER: If he cannot supply, order direct on 5-day trial, money-back guarantee. Remit in full for postpd. shipment; or send \$2, pay postman balance plus postage and COD.

DREMEL MFG. CO., Dept. 114-K, Racine, Wis.

Jigsawed LETTER RACK

By Bertram Brownold



Just the thing for sorting the family mail, this jigsawed letter rack also forms an interesting wall accessory. It's made from 1/4-in. hardwood or plywood with as many separate letter holders as you like. Each letter holder is held at a 30-deg. angle to the back panel with a beveled cant strip, as shown

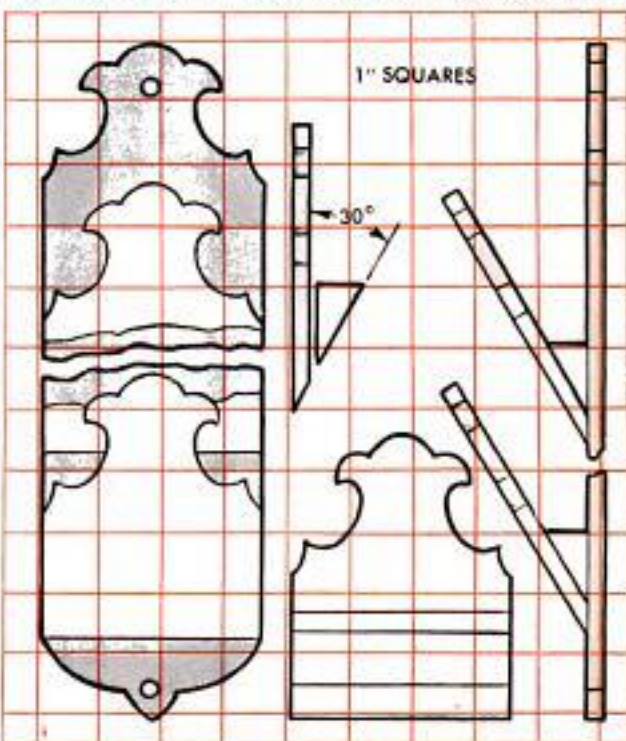



REMODELING'S EASY



with beautiful, new prefinished

MARLITE PLANK & BLOCK

Put them on the wall—that's all! Planks (16" x 8") and Blocks (16" square) go up fast over old or new walls with ordinary carpenter tools. No adhesive needed. An exclusive tongue and groove joint conceals all fastening. The soilproof baked Marlite finish never needs painting; cleans with a damp cloth. Ten beautiful "Companion Colors" styled by Raymond Loewy Associates, plus 4 distinctive wood patterns, are economical and practical for every room!

FREE! Mail postcard for folder and do-it-yourself instructions. Marsh Wall Products, Inc., Dept. 1042, Dover, Ohio, Subsidiary of Masonite Corporation.

Marlite

PREFINISHED WALL and CEILING PANELING

MARLITE PLANK AND BLOCK PATENT APPLIED FOR

MAKE THINGS! IT'S EASY with WILHOLD GLUE

IT STICKS—AND HOW!

Make drawers, picture frames, other parts without close fitting, blind dowels or mortises. WILHOLD will hold and quick too... you get more done in a day. Work can be machined 30 minutes after gluing!

BETTER PENETRATION—BETTER RESULTS WITH ORTHONOL!

AT YOUR HARDWARE, BUILDERS SUPPLY or VARIETY STORE
In Squeeze Bottle 49¢, 79¢, \$1

LOS ANGELES 31, CALIF. ACORN ADHESIVES CO., INC. CHICAGO 44, ILLINOIS

ask your dealer for **Red Devil** putty knives and wall scrapers

THE CRAFTSMAN'S WELL-TEMPERED FRIEND

Red Devil Tools.

Get your **FREE** copy of "HOW TO PREPARE FOR PAINTING." MAIL COUPON TODAY

Red Devil Tools. Dept. 149
130 Coit Street, Irvington, N. J.

NAME _____
ADDRESS _____
CITY _____ ZONE _____ STATE _____

ENJOY AMERICA'S NEWEST MOST FASCINATING HOBBY!

MOTOR-POWERED!

CUTS 1 1/2" WOOD!

3,450 Cutting strokes per minute

Only \$23.50

Complete with Rotary Motor

Pat. Appl. For

GET STARTED NOW WITH A DREMEL MOTO-JIG SAW!

Here is the basic, most versatile workshop tool around which you can build your hobby for fun or profit. It's compact and portable—ideal for apartment dwellers. Make your own lawn furniture, cornices, knick-knack shelves, home repairs, etc. Cuts 1 1/2" wood, even a 2 x 4—also plastic, metal, floor tile, etc. Powerful ROTARY MOTOR (not a vibrator) rugged enough for production work. 4-Way Blade Holder saws in any direction—takes any length stock. Table tilts 45°, raises and lowers—permits use of every tooth in blade. Fool-proof blade guard makes it safe for children. Plans furnished for making 10 useful projects. Convince yourself, after an actual comparison with more expensive Jig Saws, that Dremel is your best buy.

YOU BENEFIT 1001 WAYS WITH THE FAMOUS DREMEL MOTO-TOOL!

FASTEST, MOST POWERFUL TOOL IN ITS CLASS

—Approx. 27,000 rpm!

Dremel Electric Moto-Tool is the ideal tool for shop and home, a lightweight performer that saves time and money every time you use it! Works well in wood, plastics, and metal; carves, drills, grinds, sharpens. Proved on industrial production lines, preferred by thousands the world over. Has powerful 110V. AC-DC motor. More versatile than a 3/4" electric drill, weighs but 13 oz. A workhorse of a tool, built for years of service!

MOTO-TOOL NO. 2. Offers more convenience and long life features for the money than any other hand grinder. Thousands of satisfied users. Moto-Tool No. 2 (with 1 emery wheel point) **\$17.85**

KIT NO. 2. Includes Model 2 Moto-Tool and 23 Accessories (High-Speed Steel Cutters, Grinding Wheels, Polishers), packed in sturdy steel case. **\$25.95**

SEND FOR FREE CATALOG

SEE YOUR DEALER. If he cannot supply, order direct on 5-day trial, money-back guarantee. Remit in full for postpaid shipment; or send \$2, pay postman balance plus postage and COD.

DREMEL MFG. CO. Dept. 114-K, Racine, Wis.

If you like
fine tools



...get

The minute you take hold of a GREENLEE tool, you can "feel" the fine quality and extra craftsmanship that goes into its making.

And when you put it to work, you'll immediately see how GREENLEE tools are built to speed your jobs and help you finish them off with a skillful touch.

The next time you buy Auger Bits, Chisels, Gouges, a Spiral Screw Driver, an Automatic Push Drill, a draw knife, or other fine hand tools... "get GREENLEE"... at better hardware and building supply dealers across America.



HANDY WOODWORKING CALCULATOR... ONLY 25c

Converts linear to board feet, gives nail specifications, tool sharpening tips, compares woods, answers countless other questions in seconds.

GREENLEE TOOL CO., 2110 Columbia Avenue
ROCKFORD, ILLINOIS: Enclosed is 25c (not stamps), send Handy Calculator to:

NAME.....
ADDRESS.....
CITY..... STATE.....

Using HAND REAMERS and COUNTERSINKS



COUNTERSINKING holes with an over-size drill does not properly seat the head of a flat-headed screw like a regular countersink which is ground to match the angle of the screwhead. Countersinks, three types of which are shown above, are made with straight shanks for use in drill presses and hand drills, and with square and square-taper shanks for use in tap wrenches and braces. A stop attached to the shank is used to control the depth; in woodworking the depth should permit covering the screwhead with filler. In metalwork, the hole is countersunk to bring the screwhead flush.



Reamers are made in two general types, the taper reamer and the straight reamer, the latter actually having a very slight taper. In metalwork, separate pieces often are drilled undersize and bolted or clamped together. A taper reamer is used to align the holes, then a straight reamer is used to remove the taper of the hole to provide a snug fit for bolts or rivets.



HOW TO... SET UP and KNOCK DOWN SAWHORSES **FAST!**

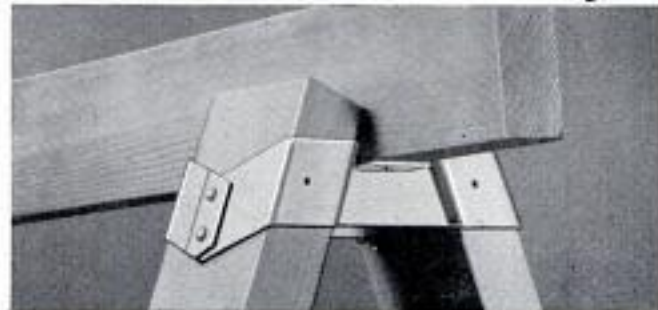

USE STRONG,
PRECISION-
ENGINEERED
NU-WAY
SAWHORSE
BRACKETS

Set up or knock down sawhorses in jig time! Carry them in your car—or store them easily—the modern way . . . the NU-WAY!

SEE Your Hard-
ware, Lumber or
Paint dealer
NOW!

ONLY
\$1.50
Pair
(\$1.60 West
of Rockies)

THOMAS PRODUCTS CO., 8490 Lyndon Ave., Detroit 21, Mich.

275 HOW-TO BOOKS— GIANT CATALOG FREE

How-to-do-it books on hunting, fishing, shop tools, concrete work, welding, plastics, carpentry, photography, boat building, gardening, auto repair, etc., in the new giant 40-page Popular Mechanics Book Catalog. Send postcard for your free copy! Write Dept. CT3.

Popular Mechanics Press, 200 E. Ontario, Chicago 11

**BUILD YOUR OWN
FURNITURE**



**IT'S REALLY
EASY**

With a set of Rogers Project Plans, you can make many attractive useful pieces for your home . . . it's simple with these easy-to-follow plans. Simple, too, using "gorilla grip" Rogers Glue. Its pure, clear, consistency, its superb adhesiveness is your guarantee that Rogers Glue is made only from the finest materials. Special Offer — Only 15c will bring you a full-sized bottle of Rogers Glue — plus a set of these remarkable Project Plans that give illustrations and directions for building furniture, household articles, toys. Mail 15c today to Rogers Isinglass & Glue Co., Gloucester, Mass. Buy Rogers Glue At Your Hardware Store. Once used, you'll never accept a substitute.



"A Ton of
Strength in
Every Drop"



Panel your fireplace wall in mahogany for Christmas for only \$74*

...and it's guaranteed for the life of your home!

Give the whole family a wonderful present *before* Christmas. You can install beautiful mahogany paneling like this over a single weekend!

Easy-to-apply Plankweld paneling uses special metal clips to hold panels in place *without* nailing through the panel itself. And each 16 1/4" wide x 8' high panel is carefully pre-finished by expert craftsmen who know and love fine wood. There's no staining or waxing to do—put panels up and the job's done!

Plankweld cleans easily with a cloth and is *guaranteed for the life of your home.*

See the complete assortment of Weldwood paneling, including superior Douglas Fir Weldwood, at your lumber dealer's. Or visit any of the 73 United States Plywood or U.S.-Mengel Plywoods showrooms in principal cities.



PUT PLANKWELD right over present wall or directly to studs. No furring needed; metal clips hold panels in place. Edge-grooved panels overlap to hide clips. Can also be installed in flush effect with new Weldwood Contact Cement.

* App. price for 8' x 12' wall; Plankweld is available in other fine hardwoods.

SEE YOUR LUMBER DEALER



Weldwood®

Pre-finished Plankweld®

UNITED STATES PLYWOOD CORPORATION

World's Largest Plywood Organization
Weldwood Building, 55 W. 44th St., New York 36, N. Y.
U. S.-Mengel Plywoods, Inc. • Louisville, Kentucky

Laminated



MADE FROM scrap lumber, this laminated bookrack is just as practical as it is good-looking. The books slip right into place with no danger of their tipping over. To make the rack, cut several boards to a length of 16 in. and a width of 7 in. Then glue together enough of the boards to attain a 5 or 6-in. thickness. When the glue

has dried, saw the laminated block according to the dotted lines in the detail. You can finish the bookrack by staining and varnishing or by painting it in any color desired. After finishing, cement felt to the underside.

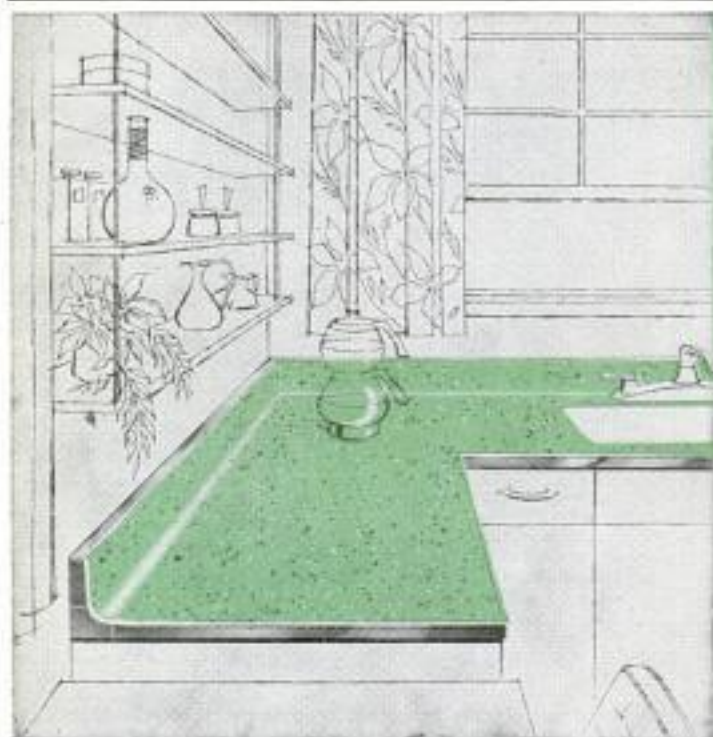
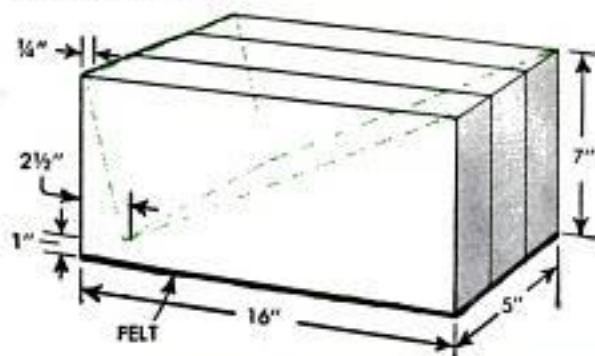

INSTALL YOUR OWN
COUNTERS WITH NEW

micarta
UNITOP

New MICARTA Unitop is made to order for "do-it-yourself" counter installations. Unitop combines top and backsplash in one piece. Its bright, mirror-smooth MICARTA surface is factory bonded to 3/4" plywood. And Unitop comes in three standard lengths, plus a corner section, to meet the layout requirements of any job. A few simple tools are all you need.

Your lumber dealer has smart, practical Unitop in many colors. All accessories too! See him today.

J-06593

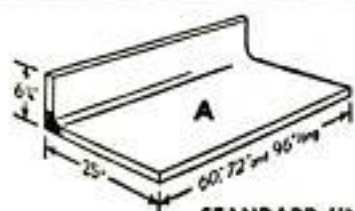

STANDARD UNITOPS

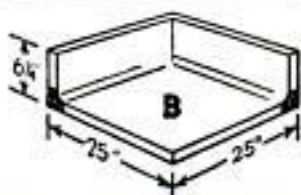

CORNER SECTION

Westinghouse



micarta

Distributed by UNITED STATES PLYWOOD CORPORATION
largest plywood organization in the world
and U.S.-MENGEL PLYWOODS-INC.

Imagine getting **ALL THESE TOOLS**
a complete home workshop
for only **\$49.95**



These attachments are all powered by one full 1/4 H.P. 1/4" 2500 RPM SpeedDrill. You also get a drill stand; portable hand saw attachment; power saw table; 5" rotary saw; bits; grinding wheel; wire brush; buffer; sanding discs; polishing bonnet; steel carrying case, etc., etc.

perfect for gifts!

At better hardware, appliance, and department stores. Write for FREE Do-It-Yourself Booklet.



SpeedWay Manufacturing Co.
a division of Thor Power Tool Company
1834 So. 52nd Avenue • Cicero 50, Illinois

Popular Mechanics Book for Pleasure or Profit

23 BOATS You Can Build

Build the boat you have always wanted. Build it for fun or to sell at a profit. Get Popular Mechanics 23 BOATS YOU CAN BUILD — row boats, canoes, sail boats, power boats and other craft including a 25 foot cabin cruiser. Book includes more than 500 photos, plans, diagrams and working drawings, plus step by step instruction that anyone can follow. Only simple tools needed. Material list of lumber, hardware, fittings, etc., included. Order today under money-back guarantee. Only \$2.00 postpaid. POPULAR MECHANICS PRESS, Dept. PM3, 200 E. Ontario St., Chicago 11



FOR SMOOTHER PAINTING

USE THE FINEST BRUSH

FREE BOOK — "How to Do a Good Paint Job!" Send card (and name of your retailer, if you wish) to Baker Brush Co., Inc., 83 Grand St., New York City 13

Brushes by Baker
AMERICA'S FINEST PAINTING TOOLS

Now... Install Your
Own Storm Windows
and Doors and

SAVE

Duo-Dor



All-Aluminum Storm-Screen Door

Converts easily from storm to screen door. Rugged construction, over one-inch thick! Complete with all hardware, including pneumatic door closer and outside aluminum door jamb.

\$69.95 Value

\$39.95

ANY STANDARD SIZE

Delivered Completely Assembled!
Easily Installed By Anyone!

Grille extra. Slightly higher in some areas!

..Duo-Matic... Extruded Aluminum 3-Track Storm-Screen Window

Lowest price ever for any comparable window! Rugged all-aluminum construction... triple-track design means glass and screen inserts are always in place, ready for immediate use.

\$29.95 Value

\$15.95

For opening sizes thru 20" x 55" double-hung windows. Other sizes slightly higher.



EASILY INSTALLED BY ANYONE!

At leading lumber and hardware dealers everywhere, or write

the weather-proof co. Dept. PM
1407 E. 40th St., • Cleveland 3, Ohio

PAINTING HINTS

USUALLY early fall is the time for exterior painting. As a rule the weather is cool and dry for long periods, providing ideal drying conditions between applications. Good paint, properly applied every three to five years is one of the cheapest home repairs. It increases the appraisal value of the property, discourages fungus growths and protects wood surfaces against weathering and changes in moisture content that cause swelling and checking.

On surfaces that have been previously painted, the amount of preparation depends on the condition of the old paint film. If it is in good condition, unbroken and chalking normally, then it will require only a thorough dusting. Wire-brushing or sanding is not necessary unless the old paint is flaked or blistered. Then all loose paint should be removed and the defective surfaces wire-brushed and sanded to feather the edges of the breaks so they will not show when repainting. Prime any exposed

wood and be sure that the primer is thoroughly dry before applying new paint.

Selecting the paint depends on whether the job requires one, two or three coats. As a rule, on old work in good condition, one coat of undercoater and one finish coat will give a first-class job. Where defective paint is removed to the bare wood in preparation for repainting, the areas involved should be spot-primed before final application of the undercoat and top finishing coat. When preparing undercoaters and ready-mixed paints for use, give careful attention to the manufacturer's instructions for reducing to a brushing consistency. The paint must be thoroughly mixed before use.

Use a brush of the correct size. A 4 or 5-in. brush is best for use on wide siding. It's faster and holds more paint, making frequent dipping unnecessary. Use a 1-in. brush for cutting in sash and door panels and a 2 to 3-in. brush for painting door and window trim.

Begin painting at the highest point on the house and work down. If you are working from a ladder, bring the trim down at the same time. When painting siding, coat the lower edges of the boards first, then finish the faces of the boards with sweeping strokes of the brush. To avoid laps, paint to a corner or a window or doorframe before stopping.



Your "Dream Kitchen" at a Budget Price!

If you've been discouraged by estimates of the cost of a custom kitchen, you'll be amazed at how economically you can do-it-yourself.

Laying the floor and doing the painting or paneling are easy, and installing WALTERS Cabinets is just as easy. Base cabinets are furnished with genuine Formica tops, or you can buy them without tops and install your own one-piece counter top. The wall cabinets are a cinch to hang by following easy instructions in our booklet (coupon below).

Your furniture or department store buys direct so they can sell you WALTERS luxury cabinets at greatest savings. WALTERS Cabinets are built of heavy gauge steel to high quality standards. Just look at these features:

- Distinctive Streamlined Radius-Edge Doors
- Concealed Full-Opening Hinges (patented)
- Sound-Deadened Doors with Rubber Bumpers
- Easy-Slide Drawers

So buy your own materials and have your dream kitchen at a price your budget can afford. But when you buy cabinets, be sure they're by WALTERS.



Walters Manufacturing Co., Dept. P-3
Oakmont (Allegheny Co.) Pa.
Gentlemen: I am enclosing 10c for handling charges. Please send booklet.

Name _____

Address _____

City _____ Zone _____ State _____

WALTERS *Steel-Fashioned* CABINETS

WRITE TODAY for booklet containing kitchen planning guide and complete information on WALTERS Cabinets for every room.

Anyone can do it...

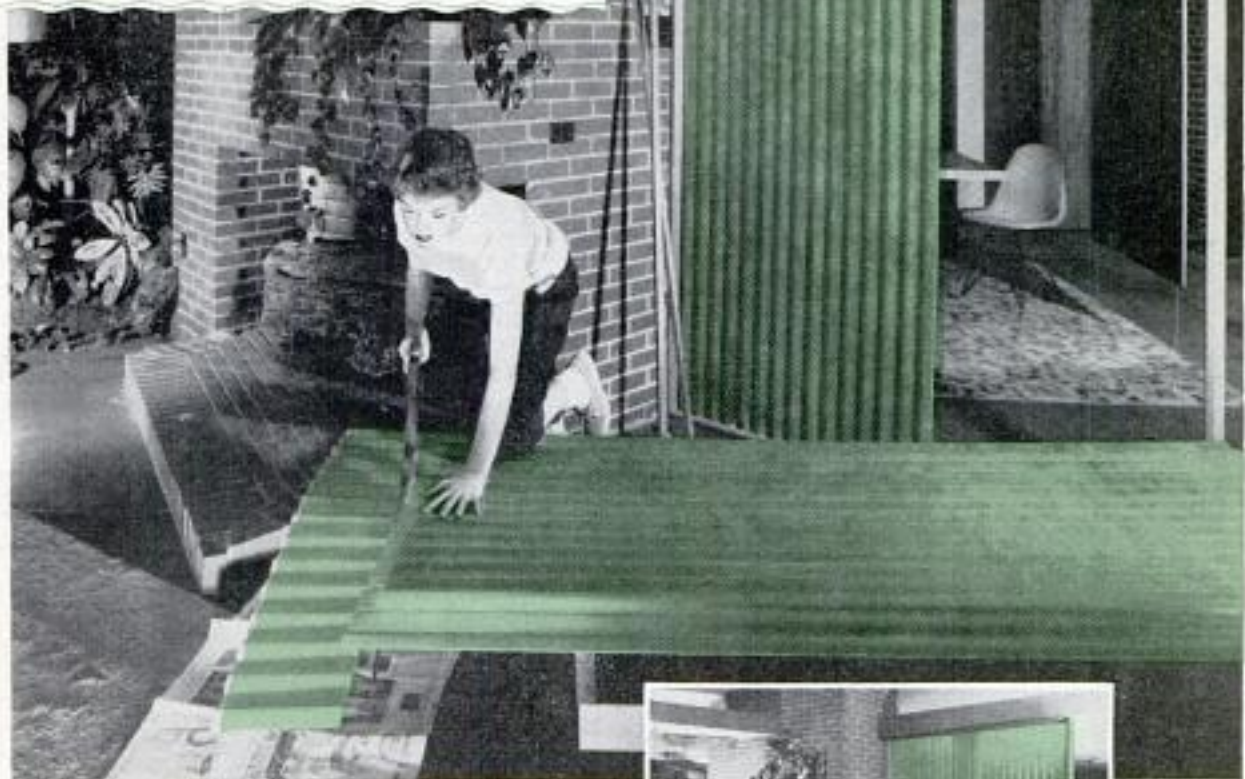

with
AMERICAN TRANSLUCENT STRUCTURAL
panal



It's easy to add new beauty and utility to your home, both indoors and out, with **AMERICAN PANAL**. This versatile material, available in many colors, sizes, finishes and corrugations, has uses limited only by your imagination. It's strong, colorful, light-weight and it's safe because it's shatterproof. You can build that patio roof, or room partition now. Send for free booklet that shows you exactly how, then beautify your home with **AMERICAN PANAL**.



**FREE
BOOKLET**

This Do-It-Yourself guide shows you, in detail, how to build a patio roof, a windscreen, a room partition and a bathtub enclosure.

Send for it today

AMERICAN PANAL, INCORPORATED, DEPT P
P. O. Box 745,
Pittsburgh 30, Pa.

Please send my free copy of the AMERICAN PANAL booklet.

Name _____

Address _____

City _____ Zone _____ State _____

AMERICA'S
BEST
POWER TOOL BUY

Mall

1000 & 1
DRILL
KIT

ONLY
\$37⁹⁵

Complete with Mall
Model I49B Drill



You get the power-packed MALL 149B $\frac{1}{4}$ " electric drill with geared chuck...plus attachments for drilling, grinding, sanding, polishing, buffing, wire-brushing, and mixing paint—all in a sturdy, steel carrying case. It's a "power tool shop" you can store in a drawer. Using your MALL Model 149B drill (\$23.95 if bought alone) as your power source, you can turn dozens of inexpensive MALL attachments into real power tools. Here are a few...



Reciprocating
Saw
\$14⁹⁵

Drill Stand
\$16⁵⁰



Slitting
Saw
\$7⁹⁵

Belt
Sander
\$16⁵⁰



GET THIS VALUABLE BOOKLET

Contains hundreds of DO-IT-YOUR-SELF tips... plus plans for 10 wood-working projects. It's yours free if you mail this coupon right away.

MALL has 40 Factory-Owned Service Warehouses,
Coast to Coast, to Serve our Customers
and Thousands of Dealers

FREE



MALL TOOL COMPANY
PORTABLE POWER TOOLS
GASOLINE • ELECTRIC • AIR

7805 S. Chicago Ave., Chicago 19, Illinois

Send me a FREE copy of "HOW TO SELECT AND USE HOME WORKSHOP PORTABLE POWER TOOLS."

Name _____

Address _____

HU-117



WIRING HINTS

How Many Appliances?

In older houses, branch circuits are wired with No. 14 wire to carry 15 amps. The fuse blows when more than 15 amps. are drawn. Add the total amperage used by the units you intend to use on one circuit. Do not attempt to use more than a total of 15 amps. at one time. Do not attempt to replace a 15-amp. fuse with a 20 or 30-amp. fuse in order to use more appliances, as overloading will cause the wires to overheat, creating a fire hazard. Newer houses usually are wired with No. 12 wire, which carries 20 amps., permitting more appliances to be used

CURRENT DRAWN BY TYPICAL HOUSEHOLD APPLIANCES

Appliance	Amps.	Appliance	Amps.
Auto. Toaster	7 to 11	Fluorescent Tube	$\frac{1}{8}$ to $\frac{1}{2}$
Auto. Washer	5 to 8	Electric Blanket	$1\frac{1}{2}$ to 2
Refrigerator	3 to 6	Portable Heater	7 to 11
Vacuum Cleaner	4 to 10	Television Set	$2\frac{1}{2}$ to $3\frac{1}{2}$
Iron	5 to 10	Roaster	10 to 14

Tying the Underwriter's Knot

When attaching a new plug to an appliance cord, it is advisable to tie the Underwriter's knot, as shown in the detail, before connecting the wire to the plug. This knot will prevent the cord from being pulled out of the plug, helping to avoid the possibility of short circuits and blown fuses



HOW TO CUT BX (ARMORED CABLE)

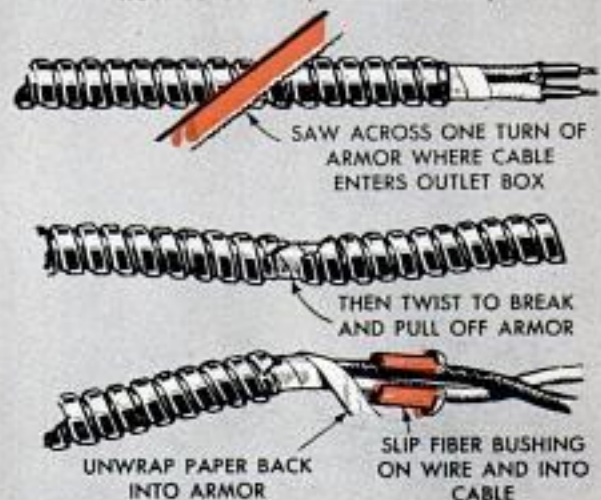

STOP SANDING BY HAND!

use the new **SAND-O-FLEX**
on curved and irregular surfaces



Only \$5.98
complete with
refill cartridge.

Use Sand-O-Flex on contoured and flat surfaces alike. This low-cost sander reaches into recesses, around intricate curves, and handles all those tedious finishing jobs that were formerly done only by hand. Fasten it to your motor shaft or any of your present stationary or portable power tools. The ideal sander for a hundred home uses. Finishes any material—woods, metals, compositions. Satin finishes stainless steel!

Sand-O-Flex consists of 6 abrasive strips backed by 6 separate brushes in a light-weight aluminum body. When rotated at usual motor speed the brushes "cushion" the abrasive cloth and mold it to the work shape. Abrasive unwinds as ends are worn. All parts are replaceable. Refill abrasive cartridges 3/4" wide, available in coarse, medium and fine for wood and metalworking. Fits 1/2" or 5/8" shafts. Adapters furnished on request.

USE IT ON A



PORTABLE DRILL



FLEXIBLE SHAFT



DRILL PRESS



LATHE



MOTOR SHAFT

Dealer territories available

MERIT PRODUCTS, INC.

4023 IRVING PLACE CULVER CITY, CALIF.

**HUNT UP
HUNTER**

**Smitty
DRIVER
FOR
ALLEN HEADS**



... make hard jobs easy!

AVOID SCATTERING and LOSING SOCKET WRENCHES

Complete set of socket head wrenches in jack-knife type handle—avoid scattering and losing. Greater leverage at any angle. Handle will not break or bend... special heat treated keys. Satisfaction or refund.

\$1.50 Postpaid

**Magic-Tip
SCREW HOLDING
screwdriver**



\$1.98 postpaid

**Magnetic
RE-CHUT**



(Retrieves
positions nails)
\$1.00
postpaid

**Magnetic
BRAD PUSHER**



\$1.90
Postpaid

at your Hardware Dealer or

Write for **FREE CATALOG**

**HUNTER
TOOLS**

HUNTER TOOLS Box 564 • Whittier, California



how to
build
"open-wide"
closets
with

**Fashionfold
Doors**

send for new
illustrated folder

Change waste space into handy wall-to-wall wardrobes, corner and hallway storage closets. You'll add beauty yet save dollars with Ra-Tox FASHIONFOLD DOORS. Woven of sturdy Northern Basswood in colors or rich natural wood. Supplied complete . . . installed in minutes. No fitting, trimming or finishing.

**Write
today!**

for new closet idea folder with easy-to-follow designs. Send 10c in coin to cover handling.



THE HOUGH SHADE CORPORATION

1066 Jackson • Janesville, Wisconsin

IN CANADA: Canadian Ventilating Shaded Ltd., Peterborough, Ont.

SOLD BY LUMBER AND BUILDING MATERIALS DEALERS

HOW TO BUILD Your Own GARAGE

Save Up to 50% of Usual Cost!

Get Popular Mechanics' brand new book **How to Build Your Own Garage** by Wayne Leckey, Assistant Shop Notes Editor, and find out how you can build your own garage at savings of 50% of usual cost. Leckey tells in clear step-by-step instructions and shows in big, clear photos, drawings and diagrams how to perform every building operation from laying the concrete to installing the final trim. There are 25 designs. Brick, frame, and concrete block fully covered. Send \$3.50 for your copy, 7-day money back guarantee.

POPULAR MECHANICS PRESS, 200 E. Ontario, Chicago 11, Ill.

**"DO-IT-YOURSELF" Easier,
Quicker, Better with VISE-GRIP**



No. 10W
10"

**the World's
Most
USEFUL
Hand Tool!**

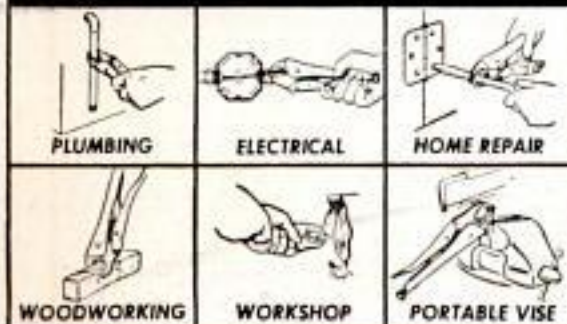

How handy you'll be with powerful, versatile Vise-Grip! A squeeze of the hand locks jaws on to work with Ton-Grip. Won't slip. Twists, turns, pulls, ratchets, cuts, h-o-l-d-s. Is a super pliers, locking wrench, end wrench and hand vise—in one trim, handy tool! **Positively** does more jobs easier than any other tool! 7" and 10", cutter optional. \$1.85 to \$2.60 at your dealer. Get **HANDY** — Get a **VISE-GRIP** today!

PETERSEN MFG. CO., Dept. M-10, DeWitt, Nebr.

**INSTALL Hi-Sprā Underground
LAWN SPRINKLER SYSTEM
YOURSELF** in a few hours



COMPLETE KIT

Saves **50%** or more!

It's Lifetime Plastic

• Permanent •

Better, can't rust

Guaranteed

America's original
"DO-IT-YOURSELF"
kit with
"Pop up"
Sprinkler heads!



**Nothing else to buy —
easy to install**

Everything Included: 10 precision brass and chrome adjustable heads, 22 lengths plastic pipe, Tees, Elbs, Couplings, Risers, gate valve—covers 1200 sq. ft. area.

At hardware, building material and electrical appliance dealers or write for descriptive folder

SPRINKLER CORPORATION

1457 SO. CONCORD ST. • LOS ANGELES 23, CALIF.

ANplus 1-7164

Hi-Sprā

Rule Bargains

give you..

jam and care.

MASTER'S GOOD for Years of Wear!

THE Bigboy
by Master

Designed in answer to consumer demand for a rugged $\frac{1}{4}$ " tape which would be rigid enough to give you accurate over-the-head measurements. The "safe lock" feature; the two way markings on both sides of the blade; and the two-way tip, are all exclusive Master features. These features plus known Master quality make this steel tape the handiest tool you have ever used. Why not ask your hardware dealer about the "Big Boy" today. You'll be glad you did.

The "Big Boy" retails at about \$3.25 each.

A MESSAGE TO HARDWARE DEALERS! If you have not as yet seen the "Master Merchant Display", ask your wholesaler about it today. Colorful, compact it does its own sales job in the smallest possible space. Will stand on the counter, fasten to the wall, or on side hinges.



SCHILDT: One thousand dollars.

LINDBLOM: This will floor you. I got my entire house and one wall in the garage plastered for \$350, including labor and material. It was a slack time in the building trades and my contractor did his own work.

O'NEIL: My walls are knotty pine and cedar paneling, except for the bedrooms. We are going to dry-wall them ourselves.

Q: Did you do your own wiring?

LINDBLOM: I did all my own wiring with the exception of having it hooked up to the service box. I used the touchplate system as described in the plans. I found it very convenient in running switches.

SCHILDT: I did not do my own wiring.

O'NEIL: I did all of mine except running the circuits into the fuse box. And here's something to remember. I used No. 12 wire. I understand you can use 14, but I figured 12 would be safer. Consequently, we used half-inch conduit. I probably should have used three-quarter inch conduit. In using half-inch, I had to run extra conduit sometimes, just for a single wire. Now I wish I had considered the touchplate system.

LINDBLOM: I also used the No. 12 wire throughout. We are allowed to use Romex in Arcadia.

SCHILDT: I used 12 and 14, depending on the loads. I used BX and some neoprene, the latter underground to eliminate overhead wires. I used rigid conduit in my foundation on the exterior walls.

Q: What about the plumbing?

O'NEIL: For the sewer end of it, I hired a plumber. There were a few things I did myself like hooking up to the lavatory and to all fixtures. I put in the water pipes myself, found that fairly easy.

SCHILDT: I had a plumber come in, but I did run my own water from the city water line (400 feet away) into the house. I ran all my own waste drains out and made my septic field and installed the septic tank. (I learned that after you bury a septic tank you should fill it with water immediately. This keeps it in the ground in case of rain.) For the heating and plumbing, interior work, leading and things like that, I let the plumber do it because to buy tools would be an extra expense.

O'NEIL: The company from whom I bought my plumbing equipment loaned me the tools.

LINDBLOM: I had a plumber come in and put in the sewer pipes and do the leading. I dug the trench myself. I figured it would cost too much to buy or rent the tools. I did put in my water and gas pipes.

SCHILDT: When I bought my plumbing supplies I went to a manufacturer's showroom and made a list of the retail prices.

(Continued to page 348)

WONDER SAW BIT



DRILLS OWN
STARTING HOLE!



Drills and Saws

New combination bit for electric drills. May be used as a drill, a saw or a reamer. Use for circles, ovals, squares, inside, hard-to-reach work. Works equally well in metal, pipe, wood, plastic, etc. Easy to use. Every carpenter, mechanic, electrician, plumber, hobbyist needs one. Made of abrasive resistant, hi-speed steel. Stands severe, continuous use without breaking. Resharpened free. Use with electric drill, slow drill press, lathe or milling machine. 1" diameter, 2" cutting section, total length 3 1/2". Three types—specify wood, metal or all purpose. Set of 3, \$5.75. Details on request. Dealer inquiries invited. **MONEY BACK GUARANTEE.** Shipped same day. **ORDER NOW!** Send check or money order to:

WONDER DRILL COMPANY

Box 8321, Dept. PM Kansas City 6, Mo.



only
\$1.95

A CHILD CAN WATCH YOUR HULL AUTO COMPASS AND TELL WHEN YOU'RE WRONG



Beaconlite 16.35
ILLUMINATED
STREAMLINE 14.95
NON-ILLUMINATED

• Yes, as long as you know your general direction of travel, a child can watch your Hull Auto Compass and spot a wrong turn as instantly as you. It's that simple, and SURE. Patented, exclusive Hull features assure greater accuracy and ease of compensation. Insist on Hull, the only auto compass, as a stock item, approved and used on thousands of U. S. combat vehicles in World War II.

MORE HULLS IN USE Than All Others Combined
Write for local dealer's name, free literature.

HULL MFG. CO. P. O. Box 246, D-10
WARREN, OHIO

Now! Do Your Own CEMENT Jobs with Ready-to-Use SAKRETE

Cement Mixes in Convenient Bags

Home cement repair and building jobs made easy. Sakrete comes in 3 balanced formulas—concrete mix, sand mix, mortar mix—to give a professional job quickly, economically. Get it at hardware or building supply stores.

Send 10c for 44-Page Book

Page after page of pictures and instructions for patching walks, laying bricks or flagstones, setting posts, fixing cracks in walls, floors, etc. Address: Sakrete, P.O. Box 11-E, Cincinnati 17, Ohio.



JUST ADD WATER

Make BIG SAVINGS With FACTORY-DIRECT PRICES!

47 BRAND NEW AIR COMPRESSORS — SURPLUS
1/2 HP—\$80
3/4 HP—\$160
1 HP—\$180
2 HP 3 phase—\$275



3 HP, 3 phase, 60 gal. tank—\$395.
5 HP, 3 phase, 80 gal. tank—\$395.
7 1/2 HP, 80 gal. tank—\$705.
10 HP, 80 gal. tank, 3 phase—\$805.
15 HP, 120 gal. tank, 3 phase—\$1200.
20 HP, 120 gal. tank, 3 phase—\$1300.

All voltages and phases available. Write for particulars. GENERAL SPECIFICATIONS: (COMPRESSOR) Timken main bearing; semi-steel piston; cushioned steel valve. (TYPE) Two stages, 200 lb. PSI (TANK) built ASME specification for 200 lb. working pressure; tested to 300 lbs.; test certificate furnished. (MOTOR) Standard make, 1750 RPM (STANDARD EQUIPMENT) Pressure switch; air gauge; safety valve; tank drain; shut-off valve.

ELECTRIC WINCHES—Direct-to-you Prices
1/2 HP master gearhead driven winch with drum, with 110 500 lbs. Pull 130 lbs. \$98.00
3/4 HP Electric Ball Bearing, Compact gear box, 12 RPM drum speed \$165.00
1 HP, same as above. More lifting power, greater speed. \$185.00
Super-duty 3/4 HP Ball Bearing, with 24 to 1 worm gear reducer. Length 36", Width 26", Height 17". Pull 3500 lbs. Complete with 100 ft. of aircraft cable, up-and-down buttons. . . . \$245.00
All electric motors Heavy-Duty, Repulsion-Induction, Instant Reverse, 110 V single phase, 3 phase available.
Complete Stock of Limit Switches, Magnetic Brakes, Magnetic Reversing Switches, Aircraft Cable
1/2" 1/2" pre-formed aircraft cable 17c ft.
3/16" pre-formed aircraft cable 12c ft.

NEW SPEED REDUCERS — FOOTE BROS.
30 to 1, 2 h.p. Regular \$138. Only \$65
5 to 1, 4 h.p. Regular \$138. Only \$65

CUTLER-HAMMER HEAVY-DUTY PUSH BUTTONS
Dust-proof, waterproof, shockproof, "Start and Stop" Only \$3.95
Regular \$21 "Up and Down" or "Forward and Reverse" Regular \$21. Only \$9.95

Here are only a few big \$ \$ \$ savings! More in our catalog!

Air Compressor	Electric Motors	Hand Truck	Rubber Cable
Air Tank	Electric Switches	Hydraulic	Rubber Wheels
Block & Tackle	Elevator	Cylinder	Saw Tables
Blowers	Drawing	Hydraulic	Shower Sprays
Bomb Trailer	Elevator Incline	Slasher	Starters
Buzz Saw	Fans, Exhaust	1 Beam Trolley	Tools
Compressor	Fans, Heat	Lawn Mower	Transformers
Accessories	Booster	Sulky	Whiting Hoist
Clutches	Gas Engines	Magnetic Starter	Wilton Vise
Conveyors	Generators	Mail Chain Saw	Winch, Electric
Welding Tools	Grinders	Ball Grinder	Winch, Hand
Drop Cords	1/2 Ton Wagon	Pumps	Fire Extinguisher
Electric Hoists	Male Fire Pump	Reduction Gear	4 Wheel Trailer

Get this catalog! 88 pages, packed with useful charts, information, plans for dummy & incline elevators, more than 1100 tool and equipment items at money-saving, factory-to-you prices. Send 25c (refund with first order) or write on company letterhead for free copy.

C&H ELECTRIC MACHINE Co. Inc.
434-K W. Juneau Ave., Milwaukee 3, Wisconsin

Say "MERRY CHRISTMAS" to the "do-it-yourself" fan with this new ROTARY STORAGE STAND



ONLY \$15.50
Complete
3-Tray Unit No. 8116-C

- Stores 2 to 4 times as many different items (nails, screws, washers, etc.) as with drawers or boxes.
- Prevents rust, dust, damage and corrosion.
- Items instantly visible through the combination of glass jars and rotary action.
- Eliminates mixing of small parts.
- Accessibility through easily removed jars.
- Includes ten 4-ounce, eight 8-ounce and six 16-ounce glass storage containers.
- Assembles to a sturdy, compact height of 13 3/4 inches.
- Ideal for handy, time-saving use in workshop, den, lab, toolroom, office or kitchen.
- Priced right—at only \$15.50.

**Immediate Delivery!
ORDER TODAY
From This Ad!**

The Union Metal Manufacturing Co., Canton 5, Ohio
10-day money-back guarantee if not satisfied!

Please send me, shipment prepaid, the 3-tray Vu-O-Matic Rotary Stand No. 8116-C. Enclosed is my check (or money order) for \$15.50 . . . or
 Send C.O.D., freight charges collect.

Name _____
Address _____
City _____ Zone _____ State _____

Save
up to \$75

Make your own 10 INCH TILT ARBOR SAW

Complete KIT

\$19⁹⁵

less guard
and blade

Prepaid.



Money back
guarantee.

Write for
**FREE
PLANS**

You get all machined metal parts, all necessary screws, nuts, bolts, and washers, plus FREE PLANS that are simple as a-b-c! All you need are a few pieces of inexpensive 3/8-inch plywood to build a Tilt Arbor Saw with the precision performance of saws costing up to \$95! Blade tilts to 45° angle, table always remains level. Cuts hard or soft woods up to 3-5/8 inches thick. Cuts 2x6s in 2 1/2 seconds. Makes frames, joints, slots, etc. Rips wide or narrow panels. Cuts joists, sidings, rafters. Bevels, mitres, cuts compound angles, and dadoes. Plana Centric Suspension adjusts blade instantly for height and tilt, locks rigidly. Trans-Axial Motor Drive keeps belt always tight and untwisted. Self-Adjusting Rip Fence stays parallel

AMERICAN MACHINE & TOOL CO.
Dept. 10 Royersford, Pennsylvania

Do-It-Yourself LUMBER CATALOG

FEATURING AMERICA'S FINEST
FURNITURE AND CABINET LUMBER
FOR THE HOME SHOP CRAFTSMAN



Now you can buy your "Do-It-Yourself" Lumber in small quantity orders of \$20 or more. Send for new 32-page, net price catalog which contains detailed information on 16 species of Furniture Lumber, Plywood, Dowels, Turning Squares, etc., as used by the home craftsman.

● For complete catalog, send 15c to cover handling and mailing costs.

**HARDWOOD CORPORATION
OF AMERICA**

E. L. DIVISION
Box 1091, Dept. M
Asheville, N. C.

I enclose 15c for "Do-It-Yourself" lumber catalog.

Name.....

Address.....

City.....Zone.....State.....

Then I called up a distributing house and asked how much they wanted. It was a thousand dollars less. I paid \$1700. For my 2 1/2 bathrooms and my entire heating system and my kitchen equipment, I paid \$2800. That is completely installed.

Q: What type of floor did you lay?

O'NEIL: In the living room and hall I'm laying hardwood flooring. Just inside the front door we have a square of ceramic tile 4 by 5 feet with a 3-inch concrete slab. We have asphalt tile in the bedrooms and bathrooms, linoleum in the kitchen.

SCHILDT: I used rubber tile throughout the house, except in the bathrooms and kitchen where I used ceramic tile and vinyl linoleum. Under the tile I had to lay 5/8-inch plywood in order to get a smooth working surface.

LINDBLOM: I used ceramic tile in the bathroom and cork in the two bedrooms and living room. In the kitchen and breezeway, or den, I have asphalt tile.

SCHILDT: I used second-grade rubber tile, costs one-third the price of first-grade and what few imperfections there are can be used easily in out-of-the-way places like closets.

LINDBLOM: I also used seconds in my asphalt tile.

SCHILDT: Here's something I learned about laying tile: Always start in the center of the room and work out, so you don't have a full tile on one side and just a little sliver on the other. Also, when you are finishing off, lay your last tile—the one you have to cut—squarely on top of the one you just laid, and then use a third tile and just butt that against the wall and cut the last tile.

Q: What about heating installations?

O'NEIL: I had mine done—forced-air heat.

LINDBLOM: I have a forced-air gas furnace. It is placed in the attic out of the way. Ducts to the center of my ceilings and openings with fins deflect the heat and throw it down to the floor. It works ideally. I hired the installations done. It cost me \$425.

SCHILDT: I used hot-water baseboard heating throughout the house. That was included in the plumbing.

Q: Did you give any consideration to air conditioning?

SCHILDT: I have a spot located so I can put in one of the small units to air condition my two main bedrooms. I can stick the grillework through the outside wall behind some shrubbery and the machine itself will be hidden in the bottom of a closet.

LINDBLOM: I have no air conditioning.

O'NEIL: Nor have I.

Q: Do you have any advice on cabinet work?

(Continued to page 350)

POPULAR MECHANICS



**\$35,000
REWARD
FOR
URANIUM**

Here's your chance to "cash in!" Over \$2,500,000 in Government Bonuses have been paid for URANIUM discoveries in the past 2 years. Currently \$150,000 a month is paid to people just like you.

Precision Geiger Counters and Scintillators are the finest instruments made for URANIUM prospecting. These highly sensitive instruments are compact, lightweight and ruggedly built for field use. Prices start at \$29.95.

CONTACT YOUR NEAREST DEALER or write direct to factory for FREE 12-PAGE CATALOG, describing URANIUM and Metal detectors.



PRECISION RADIATION INSTRUMENTS, INC.
2235PM S. La Brea, Los Angeles 16, California
WORLD'S LARGEST MANUFACTURER OF PORTABLE RADIATION INSTRUMENTS

64" FLEXIBLE SHAFT USE AS ELECTRIC DRILL **\$5.95**
WOVEN WIRE CORE

REAL BARGAIN — cannot be duplicated for \$13.00. Coupling fits 1/2" or 3/4" motor shaft (state which); other end fits standard chuck. Durable, heavy. Use it for grinding, polishing, buffing, drilling, etc. Chuck for same only. Heavier constr. \$1.25. Send check or money order and we will ship P.P. prepaid or C.O.D. Plus Postage. Money refunded if not satisfied.



L. C. DOWNEY CO. — Dept. M
8004 TRAYMORE AVE., PHILA. 18, PA.

WOODWORKERS! With beautiful veneers you can use the world's choicest woods in your own home projects. We specialize in highest quality veneers and inlays for the home craftsman. Send \$1.00 for samples of 14 exotic woods. Price list and "Tips on Veneering" free.

SOUTHERN CRAFTSMEN
P.O. Box 1644

Louisville, Ky.

Nationally Famous SUMP PUMPS

1/2 Horsepower • G.E. Motor • 1 1/4" or 1" outlet
2400 Gallon Capacity • Money Back Guarantee
Fully automatic SUMP PUMP with half inch solid shaft, nichel chrome plated for lifetime protection; 115 V. AC. Smooth, dependably operating for maximum pumping performance. Made of all non-ferrous metals, 20" high. Oilless bearings, enclosed positive switch. Parts always available. Order today, send check or M.O. We pay freight.

SIN-JIN PRODUCTS CO. 5234 Fairlawn Avenue
Baltimore, Md. **22.95** Pump only

A BIG-VALUE HOME!

You get most for your money in a roomy, convenient, furnished and equipped Schult. Insulated for all-season family comfort. Quality, value famed for 20 years! Find out...

SCHULT SEND FOR FREE FOLDER



SCHULT CORP. DEPT. 3210, ELKHART, IND.

OCTOBER 1954

**CUT
FUEL
BILLS**

**UP TO
40%**
with

TORIDHEET'S

*Direct
Heating
Action*



Unlike conventional heating units TORIDHEET'S flames actually contact the walls of the combustion chamber, communicating their tremendous heat directly to the surfaces which heat the water or air.

This direct heating action insures the maximum efficiency from your fuel. Think what this means to you—in dollars and cents.

COMPARATIVE EFFICIENCY TABLES

Conventional Coal Furnace	Oil in Ordinary Burner	Oil in Toridheet Burner
Heat	Heat	Heat
Wasted Gases	Wasted Gases	
Soot and Carbon	Wasted Gases	
Ashes and Cinders	Carbon	Wasted Gases

Complete furnaces or conversion burners—oil or gas

For Fuel Savings up to 40%
MAIL THIS COUPON TODAY!

TORIDHEET DIVISION
Cleveland Steel Products Corporation
16027 Brookpark Rd. • Cleveland 11, Ohio

Please send me complete facts on the TORIDHEET Wall Flame burner with direct heating action.

Name _____

Address _____

City _____ Zone _____ State _____

349

Copyrighted material



*Give your car engine
graduate nursing care!*

WIX Oil Filter Cartridges provide the watchful care over lubricating oil that means car engine health for you... WIX filters out all the grit and dirt your oil collects in use, giving you constant engine protection and maximum oil mileage.

wix
ENGINEERED FILTRATION

WIX HEVI-DUTY Cartridges far exceed engine manufacturers' specifications and are especially engineered for your individual engine. In taking out more contaminants they still preserve the detergency in today's heavy duty oils. Ask your Serviceman for WIX... you'll keep your oil clean, your car engine well lubricated and really healthy. You'll like the careful nursing WIX gives your pocketbook, too.



wix
TRADE MARK REG.
OIL FILTERS • CARTRIDGES

WIX CORPORATION • GASTONIA, N. C.
IN CANADA: WIX ACCESSORIES CORP. LTD., TORONTO

SCHILDT: I made my kitchen cabinets out of plywood treated with a plastic coating. Here's something I found helpful: Just before you plaster, be sure you mark off the center line of your studs on the floor so you can find them again.

Q: How long did it take you to build your home?

SCHILDT: It took me 9½ months—from the middle of June to April 2. When we moved in my doors were not hung and my tile was not down.

LINDBLOM: The concrete was poured March 31 and we moved into the house around Jan. 1. That is nine months and I spent half of that time on the road, so I figure it took me 4½ months of actual building to finish the house.

O'NEIL: It is taking 17 months of spare-time work to build my house.

Q: Can you estimate how much you saved by building your own homes?

SCHILDT: My house, including lot, cost me \$18,000. A real estate agent told me it's worth all of \$35,000 right today—that's \$17,000 to the good.

O'NEIL: My house would cost about \$20,000 to have built. It cost me \$14,000 plus my labor. If I put it up for sale I might get \$25,000.

LINDBLOM: My house cost me \$7000. My garage, of course, was on the lot. A contractor told me the house would have cost \$15,000. I figure I saved \$8000 by building it myself. I could sell it for \$20,000 or more.

Q: What was your worst mistake?

SCHILDT: My worst mistake was not using steel beams in the basement. I priced a steel beam for across my garage (it's in the basement) and it was \$50. I figured a steel pipe filled with concrete would cost me \$7, so I said that was it. I have a wood beam with no support between walls in my recreation room. That is 16 feet long. There is a slight sag in the center of that now and I'm going to have to tear it out and put in a steel beam someday.

O'NEIL: I think you'll find that true in most places. In regard to mistakes, my biggest on was not thinking the whole thing through. I didn't do enough planning, figuring on costs or shopping around. I did not do enough checking on my levels and verticals.

Q: Would you build it yourself again?

SCHILDT: Yes.

LINDBLOM: I certainly would. Also, I would follow a how-to-do-it plan as I did before—especially after hearing what I have today about the mistakes made.

O'NEIL: Yes, I'd do it again despite the mistakes and backaches. Aside from saving a lot of money there's a big thrill in building your own home. ★ ★ ★

Can You Equal This Home for **3128**



Shipped Direct from Our Mill

Act Now!

Save 30% to 40% on Your New Home

You can save several thousand dollars when you build a Liberty Home! Buy direct from our mill at our low, factory, freight-paid price. We ship you the lumber cut-to-fit, ready to erect. Doors, windows, roofing, paint, glass, hardware, nails, etc., all included in the price. Plans furnished—also complete building instructions. No wonder our customers write us that we saved them 30% to 40%. Easy terms—monthly payments. Architecturally approved construction. (Not pre-fabricated.)

Send for FREE BOOK of Liberty Homes

Handsome Big CATALOGUE Pictures wonderful homes in colors at money-saving prices. Write for FREE catalogue today. (West of Mississippi, 35c)

LEWIS MANUFACTURING CO. 1240 Lafayette Ave., Bay City, Mich.

NEW LOW-PRICED QUALITY TOOLS!

This durable PORTABLE HACK SAW ATTACHMENT easily saws metal, wood, and plastics. Fast action, simple to use. All around tool gives years of service. Housing of aluminum alloy casting. Complete with 2 blades. Satisfaction guaranteed. Order today! Send check or money order. Immediate shipment, postage paid.



\$15.95

Fits any 1/2" electric drill

DURA-TOOL

Write today for Free Catalog on entire line of tools!

CLIZBE BROS. MFG. CO., PLYMOUTH, INDIANA

NEW! MIRACLE WOOD DRILL "SCREW-MATE" DOES 3 JOBS AT ONCE!

Drills shank hole, pilot hole and countersinks in one operation on wood or plastic. Automatic stop at right depth... Insures 100% holding power. Drill up to 40 holes p.m., easily, accurately! High-tungsten steel, hardened and ground, outlives ordinary drills. Fits all 1/4" chucks. Utility Kit 5-popular sizes with stand. **\$3.95** post paid



1 SET 5 SIZES
3/4" x 7
1" x 8
1 1/4" x 8
1 1/4" x 10
1 1/2" x 12

FREE FOLDER describing other "do-it-better-easier" tools.

Engle Products

BOX 84A, MERIDEN, CONN.

• WELDS, CUTS, HEATS •

No Attachments Needed

PREST-O-LITE Oxy-Acetylene Outfit

Trade-Mark

- Slices through heavy steel; welds sheet and light plate. No limit to the repairs you can make or useful things you can build. **Only \$76.50.**
- Oxygen and acetylene in cylinders sized to meet your needs.

Write today for free descriptive booklet.

LINDE AIR PRODUCTS COMPANY

A Division of Union Carbide and Carbon Corporation
30 East 42nd Street **UNION** New York 17, N. Y.

Make \$20 to \$30 a Week
EXTRA MONEY



MACHINE SAW FILING PAYS UP to \$3 or \$4 an HOUR

• Turn your spare time into CASH—sharpening saws with a Foley Automatic Saw Filer pays up to \$3 or \$4 an hour. You will find you can make \$20 to \$30 a week in your spare time as a starter.

You can work in your basement or garage—no experience necessary. "The first saw I sharpened with my Foley Filer came out 100%"—writes Clarence E. Parsons. No canvassing—"I advertised in our local paper and got in 93 saws"—says M. L. Thompson. The Foley is the only machine with which you can file all hand saws, also band saws and cross-cut circular saws.

SEND FOR FREE BOOK "MONEY MAKING FACTS"

Shows how you can get business from home owners, farmers, carpenters, schools, factories, etc. With a small investment, no overhead, no stock of goods to carry, you can get right into a cash business,—and possibly later on develop into a full-time repair shop. Send coupon today for Free Book. No salesman will call.

"Each saw I filed got me six more and business has been picking up that way since a year ago. If it keeps up I will have to buy another Foley Saw Filer." William C. Baldwin

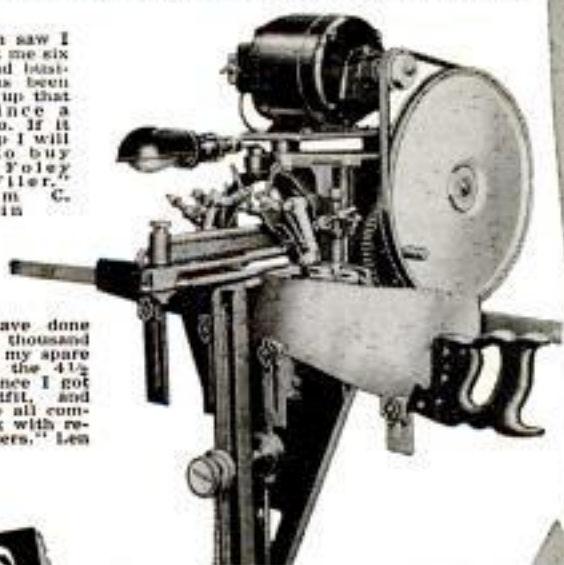

"I have done 4 or 5 thousand saws in my spare time in the 4 1/2 years since I got the outfit, and they are all coming back with repeat orders." Len Crego



Send Coupon for FREE BOOK

FOLEY MFG. CO., 1016-4 Foley Bldg. Minneapolis 18, Minnesota

Send FREE BOOK—"Money Making Facts"

Name _____
Address _____

Science Speeds Shaving With "Canned Lather"!

That's right! They've invented a gadget that makes shaving faster, easier, more pleasurable! Now you can get rich, creamy lather right out of a can . . . ready to use!

No brush to slow you down . . . no greasy cream to clog your razor. Just push valve . . . out comes lather! That's AERO SHAVE . . . the wonderful new "canned lather" that contains 3 beard-softeners to wilt toughest whiskers in a jiffy . . . plus soothing lanolin to protect your skin against shaving irritation.

Get AERO SHAVE Lather Bomb today . . . in the handy metal container with the turret top that won't leak when you travel.

Not 79¢ . . . Not 69¢ . . . Only **59¢**

USE "PUSH-BUTTON" LATHER

AERO SHAVE



Also economical King Size—12 oz. only 98¢

BACK AGAIN!

4 TOOLS IN 1
Bigger! Improved!

the complete
Metal Work Shop

**FORMS
SHEARS
PUNCHES
RIVETS**



Patent No.
2053309

ONLY
9.95

Postage
Paid

Send check
with order.
Satisfaction
guaranteed
or full refund.
No. C.O.D.'s.

Now this one compact unit offers more than ever before. Five punch sizes . . . bigger . . . handles larger stock . . . simplified operation . . . does more. The perfect all-purpose tool for hobbyists, craftsmen, radio repair, metal shops, model manufacturers, experimental laboratories, etc.
SPECIAL — Threading dies for 1/8", 5/32" and 3/16" stock included for only \$1.00 extra.
EXTRA punches available in square, rectangular and hexagon shapes. Only 40c each.
SAVE! BUY AT WHOLESALE! Send 50c in coin or stamps for 64 page Catalog of Name Brand items you can buy at wholesale.

ALBERT J. TATU, INC.

85 COLUMBIA DRIVE, DEPT. PM-10
WILLIAMSVILLE, N. Y.

Multiple-Speaker Enclosures

(Continued from page 247)

INFINITE BAFFLE — BILL OF MATERIAL			
ITEM	REQ'D	INCHES	NAME
1	4	3/4" x 4 1/2" x 5 1/4"	Spk'r panels*
2	2	3/4" x 4 1/2" x 3"	Blank panels*
3	1	3/4" x 8" x 4-13/16"	Spk'r pan. div.*
4	2	3/4" x 9 1/4" x 2"	Inside pillars
5	1	3/4" x 9 1/4" x 8"	Back*
6	2	3/4" x 10" x 7 1/2"	Top and bottom*
7	2	3/4" x 3/4" x 9-5/16"	Front pillars
8	2	3/4" x 1 1/8" x 9-5/16"	Rear pillars
9	4	Type 4J4 Jensen PM speakers (4")	
Note—	1	Piece of glass-fiber insulation (see text)	
	1	6-terminal output strip	

*=PLYWOOD

BACK-LOADED SYSTEM — BILL OF MATERIAL			
ITEM	REQ'D	INCHES	NAME
1	4	3/4" x 9 3/4" x 12 1/4"	Spk'r panels*
2	1	3/4" x 8" x 10"	Top for panels*
3	1	3/4" x 12 1/8" x 13"	Front brace*
4	1	3/4" x 22 3/4" x 26 1/4"	Back*
5	1	3/8" x 27 1/4" x 14 3/8"	Top trim*
6	1	3/4" x 26 3/8" x 14 3/4"	Bottom*
7	3	3/4" x 1 3/8" x 24"	Front pillars
8	2	3/4" x 3/4" x 24"	Rear pillars
9	4	3/4" x 5" x 8"	Braces*
10	4	Type P6TX Jensen PM Speakers (6") (extended range; 3-4 ohm v.c.)	
11	1	1/2" x 6" x 6" piece of sponge rubber	
12	1	15/32 shank d.p.d.t. bat-handle switch switch	
13	1	2-terminal output strip	
14	5	3/16" x 1 1/4" x 24 1/4" Trim slats	
Note—	1	26" x 45" piece of grille cloth	

*=PLYWOOD

the other way four speakers are in parallel for 16 ohms. The switch is mounted directly on the back panel below the two-terminal output strip. The grille cloth is held on the back-loaded system by slats, item 14. The frames for both enclosures should, of course, be sanded and finished before the grille cloth is applied. The back panel is held in place by wood screws as illustrated in photo H. The terminal strip and switch have not yet been mounted. The standard grille cloth should be large enough to permit about 1 1/2 in. to be tacked under the bottom. At the top, the cloth is held by 3/8-in.-square wood strips nailed to the underside of the top trim, item 5, between the pillars.

Detailed student material list R-428 is available from Popular Mechanics Radio-TV and Electronics department upon receipt of ordinary letter postage. ★ ★ ★



DO MORE PLANING JOBS WITH LOW COST BELSAW

Exclusive **MONEY-MAKING** features:



- Full 12 3/4 in. x 6 in. capacity
- Power feeds at 24 ft. a minute. (Easily adjusted for lower feed rate)
- Machined cast iron bed; adjustable rolls, total bed length 42 in.
- Provides for Grinding Knives in the Cutterhead.
- Attachments for Jointing, Rabbeting, Tongue, Groove, Matching.

Belsaw Multi-Duty Planer for cabinet shops, builders, lumber yards, woodworking plants and spare time work shops... Now you can convert low cost rough and random size lumber into high priced cabinet finished stock... Easy to make flooring and popular patterns. Belsaw quickly returns cost with savings on raw material... profits on finished stock.

Send Today for **FREE** literature on Belsaw, the **LOW COST**, high speed production planer.

BELSAW MACHINERY CO

1010 Field Bldg. • Kansas City 11, Missouri

**LOW DOWN
PAYMENT
EASY
TERMS**

MONEY MEN ALL FREE
DATA

THE PLASTEX Industry needs manufacturers on small scale and for big production of Lamp and Clock Stands, Art Goods and Novelties in Plastex and Marble imitation. Experience unnecessary. Lac material makes regular 10¢ store sellers. Rubber moulds furnished for speed production. Small investment brings good returns. We are now placing big Chain Store orders with manufacturers. Ambitious men have chance for real prosperity. Our Free booklet will interest and benefit you.

PLASTEX INDUSTRIES, Dept. A
3400 Third Ave. New York 56, N. Y.

TOOLMAKERS • MACHINISTS • GUNSMITHS!
G. M. LAPPING PLATES are precision ground for all fine finishing on parallels, gages, gun parts, etc. . . Also used for sharpening clipper blades.

\$8.50 SEND CHECK OR MONEY ORDER

Packed 1 in a box with grinding compound and instruction sheet

GENERAL METALS CO., Chillicothe, Ill.

PLATE SIZE:
4 1/4 X 4 1/4 INCHES

HASTINGS STEEL-VENT PISTON RINGS
The best money you can spend on your car!

**LEAVES
VANISH!**
**GRAVELY
LEAF MULCHER**



does away with leaf raking, leaf burning . . . gets rid of leaves in minutes instead of hours!

WITH **GRAVELY CHAIN SAW ATTACHMENT** you clear land, cut timber, firewood.

5-HP Gravelly Powers 21 Tools—does every lawn, garden, field and farm job faster, easier, better. Write for **FREE** Booklet. "Power vs Drudgery."

GRAVELY TRACTORS, INC.
BOX 1063 DUNBAR, W. VA.

Gold Bond Announces
New double-action

TWINSULATION



FAMOUS
FIREPROOF
Gold Bond
SPUN ROCK WOOL

ALUMINUM
REFLECTIVE
COVERING
ON BOTH SIDES

New Gold Bond Twinsulation gives you *two* heat barriers that keep summer heat *out*, furnace heat *in*. Pays for itself in fuel savings alone! And next summer your home will be up to 15° cooler.

You can apply easy-to-handle Twinsulation Blankets yourself. So, whether improving an old home or planning a new one—for extra year 'round comfort, get new double-action Gold Bond Twinsulation.

NATIONAL GYPSUM COMPANY, BUFFALO 2, N. Y.

Send coupon now for this how-to-do-it home insulation booklet.



NATIONAL GYPSUM COMPANY
Dept. PM-104, Buffalo 2, N. Y.

I enclose 25¢ for which please send me your Gold Bond Rock Wool How-To-Do-It Booklet.

Name

Address

City.....County.....State.....

"SEFWELD"



Look... no hands. Just lay the electrode on the work
... Selfweld welds itself.

NEW WELD-IT-YOURSELF METHOD

Makes welding simple as turning on a light. Ideal for the home workshop.

Many people have wanted to weld at home, but hesitated because of time necessary to learn to weld.

Now look what you can do with no previous welding experience:

- Build wrought iron furniture, porch railings, garden carts, wagons, gates, tool stands.
- Repair garden tools, car fenders, wagons, toys.

With the 100 ampere welder you can also

- Solder copper pipe, electric wiring, sheet metal.
- Torch heat, braze, cut metal.

So easy. Just touch Selfweld to the work, press a switch and weld. That's all there is to it.

Selfwelding Kit includes: "Lincwelder 100" welder, headshield, cable, electrode holder, "Selfweld" electrodes. Only \$99.00 F. O. B. Cleveland, Ohio.

ORDER NOW! "LINCWELDER 100"

Complete with accessories.

MAIL COUPON TODAY



The Lincoln Electric Company, Dept. 2902
Cleveland 17, Ohio

Name _____

Address _____

City _____ State _____

Send me the Lincoln Selfweld Kit _____ enclosed
is check _____ money order _____ for \$ _____

Send Selfweld Bulletin giving more information
on home welding.

Don't Get Lost in the Wilderness

(Continued from page 133)

move until you have made a definite plan.

2. Shout, call or shoot into the air three successive times at frequent intervals if companions may be near by.

3. Try to recall the circumstances that caused you to get lost.

4. If you have food, ration it to last for several days. Look for fruits and berries.

5. Establish a camp where you are. Pile up rocks or branches, marking a base from which to operate.

6. Go up a hill or climb a near-by tree to look for some familiar object. Always come back to your base camp if you fail to recognize anything.

If you must leave the area, mark your route by signs at regular intervals. Strips of cloth or paper may be fastened to trees or bushes. Branches may be broken and left hanging. Rocks may be arranged on the ground to form an arrow, marking your direction. Always know which way you are going. Here are some aids in finding and keeping directions:

1. Learn to use a compass, of course.

2. In taking compass bearings, sight the compass on an object some distance away, go to that object, then sight from there on another object and proceed to that. Do not try to carry the compass and follow the needle as you walk.

3. If several are in the party and there are no objects to sight on (as in snow fields or during fogs or storms), direct them ahead of you in a straight line while you stand holding the compass.

4. Keep in mind the general direction of rivers and ridges.

5. Check the compass often on the way in. Remember that 180 degrees from the direction you go in is the way out.

6. Establish prominent landmarks on the way in, such as trees, rocks, mountains.

7. The sun is directly south at noon. Your watch makes a fairly accurate compass. Point the hour hand toward the sun; half-way between the hour hand and 12 is south with the watch on standard time.

8. Determine the direction of prevailing winds on ridges as you go in. Trees often bend away from these winds.

9. If crossing a wide, snow-covered or desert area, mark your route if there is a chance of fog or storm. Wands or branches with cloth strips attached will do.

10. In woods, streamers may be tied to low tree branches or other objects, especially if children are in the party.

Getting lost, even briefly, is frightening. Don't get panicky. Follow these rules and you'll come through safely. ★ ★ ★

POWER HYDRAULICS for SNOW PLOWS

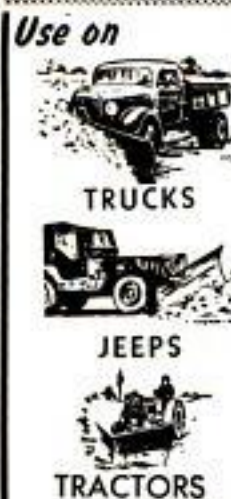

HY-LO-JACK
does the job
FASTER-EASIER

- Lifts average snow plow in 3 to 10 seconds.
 - 1,000 lbs. per square in. pressure
 - Quick, easy installation on new or existing equipment.
 - Complete kit form, including the pump, tank, hose lines, etc.
 - Electric unit also available for 6 or 12 volt systems.
- * Write for Circular. See your Road Machinery, Jeep or Farm Equipment dealer.

MONARCH ROAD MACHINERY CO.
Quality Machinery since 1856
1331 Michigan St., N.E., GRAND RAPIDS, MICH.

Now, for the first time, you can build fine furniture and cabinets of

Rare and beautiful Hardwoods

from the forests of the world . . . selected, seasoned, processed and delivered postpaid to you by America's largest wholesalers of hardwoods . . . at prices lower than you would pay locally IF you could find them!

FREE 4-COLOR FOLDER

illustrates 12 rare woods in full color, also prices and simple ordering directions. If you like to work with wood, don't fail to write today for your free copy!

PAX-Pak Division
FRANK PAXTON LUMBER COMPANY
6317 ST. JOHN AVE. KANSAS CITY, MO.



Find HIDDEN TREASURES

GEIGER COUNTERS (as shown) for Uranium Detection. **TREASURE DETECTORS** for gold, silver, etc. Lightweight, ultra sensitive. None finer. Also Mineralights for Tungsten.

• INFORMATION FREE •

Detecton Co.
5420 Vineland, North Hollywood, Calif

Send for **FREE** 112 page Illustrated Catalog of Farm, Home, and Workshop Bargains.

Write to Dept. D10 **WELLWORTH TRADING COMPANY**
1832 S. WABASH AVE. CHICAGO 16, ILL.

SHEET METAL BRAKES

New eccentric clamps. Forms angles, locks, pans, etc. Mount on bench, truck or floor stand. All steel construction.

Size 15"x16 gauge,	40 lbs.
\$21.00; 30"x20 ga.,	65 lbs.
\$28.50; 36"x22 ga.,	80 lbs.
\$33.00; 48"x24 ga.,	110 lbs.
\$48.00; 100"x28 ga.,	260 lbs.

Floor stand, 22 lbs. \$7.00. Shipped Collect. 24" Squaring and slitting shear cuts sheet metal, plastic and cardboard. For bench mounting \$38.00. Floor stands \$7.00. Express Collect. Shears 7" by 16 gauge, straight or curved, any length cuts 1/8" aluminum bars. \$12.50 collect. \$14.00 postpaid.

ORDER DIRECT, OR SEND FOR CATALOGUE.

VYKE MFG. CO., P-2439 15th St., Denver 2, Colo.

You need fewer tools
when you use ...



CHAN NEL LOCK pliers
TRADE MARK REG. U.S. PATENT OFFICE



here's why

Look for the Channellock line when you're shopping for hand tools. Channellock pliers offer features that you can't get with other makes. And when you buy a Channellock plier, ask to see the full line — you'll find a style and model to do any job better.



CHAN NEL LOCK
TRADE MARK REG. U.S. PATENT OFFICE

THE PLIER DESIGN THAT OBSOLETE ALL OTHERS

CHAMPION D^oARMENT TOOL CO. • MEADVILLE, PA.

Your engine's life depends on a film of oil 4 times thinner than a newspaper page!



High-speed engine parts work on clearances of 1/1000 of an inch or less, and oil must flow between them.

Use high-quality Quaker State for super film that's best for your engine

A SUPER FILM! Only an oil of super stability, purity, and protective qualities can produce the super film needed to lubricate modern engines properly. Quaker State Motor Oil is made to do the job: to provide a stable film that protects as it lubricates, cools as it cleans. Refined from 100% Pure Pennsylvania Grade Crude Oil, it is the product of 50 years of specialization in automotive lubrication. Economical—goes miles farther!

Quaker State Motor Oil is made in new, streamlined grades to suit the requirements of all makes of cars and for every type of service. Ask your dealer.

ASK FOR . . .



QUAKER STATE OIL REFINING CORPORATION, OIL CITY, PA.
Member Pennsylvania Grade Crude Oil Association

Owners Report on the Corvette

(Continued from page 122)

who would like to have plastic bodies on their family cars:

"Quietest body I have ever driven."—Wyoming druggist.

"Cool on the hottest of days. Tough. Doesn't dent or show scratches."—California civil engineer.

"I fixed a hole in right front fender myself in less than 3 hours, not counting painting. As easy as repairing a plastic toy. No wrinkles to pound out and no dents. After painting you can't tell the difference."—California foreman.

"Easy to keep clean, cool and no rust from salt on icy roads. Hood and rear deck did warp in Florida sun though."—New York plant owner.

"Cool and light, but apparently strong. Door panels cracked at front on both sides where they pressed against body."—Georgia physician.

"Like plastic, but unable to find anyone that knows anything about fixing a smashed fender."—California student.

"Seems to scar with very slight bumps in hot weather."—Ohio executive.

"Can't get doors, hood and deck lid to fit."—Virginia race-track promoter.

"Had back fender repaired. Small section was over \$100. A steel body repair of same type would have been less than \$25."—Michigan owner.

Automatic Versus Hand Shifting

When the Corvette was first announced as being available only with Powerglide, the automatic transmission, sports-car fans moaned audibly. They love to use the clutch and are expert at it. But Corvette

(Continued to page 358)

There is no glove compartment on the dash, but two door compartments provide ample storage facilities



General SURPLUS SALE!

BUILD YOUR OWN ARC WELDER OR LIGHT PLANT D-C GENERATOR

\$15.50 used good condition. Instructions incl. 210 Amps. 28V. **\$21.50** NEW

Stock No. 711 D.C. Generator R-1 Jack & Hints. 300 Amp. 30 Volts. Gov't. cost \$300.00. For Welder & Light plant. Instructions. **\$25.50**

RHEOSTAT #R-27. Heavy duty for regulating voltage on the P-1, R-1 or A.C. D.C. Generators. **\$6.95** post paid

CARBON PILE VOLTAGE REGULATOR #A1250. For Maintaining voltage & check pulsation on D.C. Generators. **\$6.95** post paid

115 V. A. C. GENERATOR

Stock No. 511 Makes Ideal A.C. Light Plant & D.C. Battery Charger. 312. By G.E. Rated 1250 Watts, 800 Cy., 10.0 Amps, 115V. A.C. & 200 Amps. 30V. D.C. Gov't. cost \$300.00. Instructions incl. Wt. 50 lbs. Used. **\$22.50** NEW **\$32.50** good cond.

AMPLIDYNE MOTOR GENERATOR. New. Use as 24/32 D.C. motor, pulls 5 1/2 H.P. Applicable for 110V. A.C. for independent or rural lighting. Instructions incl. Wt. 30 lbs. Gov't. cost \$140.00. **\$7.50**

BOMB INTERVOLLOMETER. New. Can be set to release current at fixed time or split second timing. Size 5"x 8"x3 1/2". For 24V. D.C. & applicable for 110V. A.C. \$50.00 value. **\$6.95**

ELECTRIC ACTUATOR incl. 1/2 H.P. motor for lifting, lowering. Remote control, etc. Motor drives actuator in 6 1/2" travel. For 24V. D.C. & applicable for 110V. A.C. Rated load 2800 lbs. #AALM Instructions incl. **\$7.95**

INSECTICIDE PUMP SPRAYER & FIRE EXTINGUISHER. 4 Gallon size heavy duty incl. approx. 3 ft. hose & fine mist nozzle. Used, good condition. Wt. 15 lbs. (Add Postage). **\$2.95** ea. **\$5.00** per pair

CUMMINS OIL FILTER. Aircraft type. Filters oil without cartridge replacement. Std. 3/4" inlet & outlet ports. STOP CHANGING OIL. **\$4.95** post paid

Send CHECK OR M. ORDER. PRICES F.O.B. KCMO EXCEPT when marked POSTPAID U.S.A.

GENERAL SALVAGE CO., 2922 E. 27 St., Dept. 714 Kansas City, Mo.

MAKES IDEAL WINCH HOIST

Operates on 12 to 32 volts. Gives high torque, slow speed & tremendous power. Applicable for pulling & moving heavy loads. Belt or direct drive. O. cost \$300.00. **\$9.95** Wt. 55 lbs. #210

BEAM ROTATOR MOTOR. Reversible, geared, 7 H.P.M., for TV, Ham, etc. Light wt. for 24V. D.C. & applicable for 110V. A.C. Instructions incl. **\$12.95**

SELF PRIMING ELECTRIC BLACK & DECKER MOTOR & PUMP UNIT. For oil burners, aquarium, fluid metering, coolant, etc. Motor rated 1/30 H.P., 1200 R.P.M. Pump rated 2 G.P.H. 1/4" ports. For 24V. D.C. & applicable for 110V. A.C. Size 4 1/2" x 7 3/4" x 3 1/2" x 3 1/4". Instructions incl. **\$9.95**

THOMPSON CENTRIFUGAL PUMP & MOTOR. For pumping fuel, oil, hot water circulator, etc. 300 G.P.H. For 24V. D.C. & applicable for 110V. A.C. Instructions incl. #1200 **\$7.50**

WINCH HOIST. Portable giraffe neck. 1500 lbs. max. Has 21 to 1 gear ratio, 10" tube extension with 3" pulley. 12 ft. of 3/16" cable & handle with ratchet brake. **\$21.50**

PESCO LARGE VOLUME UTILITY PUMP For water, oil, insecticides, etc. 400 G.P.H. 1 1/2" drive spline shaft, 3/4" ports. #600L **\$7.50**

VICKERS CONSTANT DISPLACEMENT, HYDRAULIC PUMP. New #PF28-2713-20. 400 G.P.H. 3/50 R.P.M. 1500 P.S.I. .507 Cu. In. Rev. **\$17.50**

VICKERS PUMP. New #P1-713-20. 375 G.P.H. 3750 R.P.M. .410 cu. in. rev. 1000 P.S.I. **\$14.50**

WEAVER HYDRAULIC HAND PUMP New With Built in Check & relief valve. For oil or Hydraulic Fluid. Rated 2000 P.S.I. data incl. \$75.00 Value. **\$9.95**

SOLENOID #804. Lever arm gives a 1/2" or 3/4" travel. Powerful actuator for locks, switches, toy, etc. For 24V. D.C. & applicable for 110V. A.C. Instructions incl. **\$2.95** ea. **\$4.95** pair

MINIATURE ELECTRIC MOTOR BY DELCO OR G.E. 2 1/2". D.C. .5 Amp. Approx. 2000 H.P.M. Torque 8 oz. in. **\$3.50** post paid

STRAIGHTPOWER CONSTANT DISPLACEMENT PUMP For hydraulic cylinders, tractors, bulldozers, etc. 400 G.P.H. at 3750 R.P.M. 1250 to 1400 P.S.I. & built in relief #37. O. Cost \$150.00. **\$17.50**

AIR OR OIL HYDRAULIC CYLINDERS. Stock #11—Double action 1 1/2" bore, 6" stroke, 3/4" dia. shaft. Clevis mounting, 1100 lbs. with 1000 P.S.I. **\$8.95** post paid

Stock #17. Double action 1 1/2" bore, 9 3/4" stroke, 5/8" dia. shaft. Rated 1850 lbs. with 1000 P.S.I. **\$12.95**

Stock #12. Double action 4" bore, 10 1/2" stroke 1-5/16" dia. shaft. 12,500 lbs. with 1000 P.S.I. Clevis mountings. O. Cost \$300.00. **\$27.50**

PESCO HYDRAULIC FLOW EQUALIZER & PRESSURE BALANCER VALVE. For 2 cylinders or 2 systems. Cap. 1 to 6 Gal. per minute. 1500 P.S.I. #207-D. **\$9.95** post paid

NO. 21 FOUR WAY HYDRAULIC VALVE. Off at neutral. With built in relief for limit of cylinder stroke. With 3 positions. 1st post raise, lower & hold. 1/2" ports. **\$9.95** post paid

FOUR WAY HYDRAULIC CONTROL VALVE. Poppet type. Pressure balanced. **\$7.95** post paid 1500 P.S.I. 3/4" ports. #227

HYDRAULIC PRESSURE GAUGE. Range 0 to 2000 P.S.I. 1 1/2" tube fittings. **\$3.50** post paid

HYDRAULIC SOLENOID CONTROL VALVES. Bendix #81560. For remote control & for hydraulic cylinders. For 24V. D.C. & applicable for 110V. A.C. Cap. 1500 P.S.I. \$35.00 value **\$3.95** ea. **\$7.50** pair

FOUR WAY SOLENOID VALVE Operates on 24V. D.C. & applicable for 115V. A.C. For operating hydraulic cylinder, remote control, etc. 3/4" ports. **\$9.95** New. \$50.00 value. #121

FOUR WAY SOLENOID VALVE. For 24V. D.C. & Applicable for 115V. A.C. off in neutral For Hyd. cylinders remote control, etc. 1/4" tube ports. Instructions incl. **\$8.95** post paid #324

HYDRAULIC ACCUMULATOR. Bendix Ball type. 3 1/2" dia. Rated 2000 P.S.I. Wt. 4 lbs. #A-65. **\$5.95**

SIMMONDS ACCUMULATOR. New. Cap. 220 Cu. In. Rated tested 3000 P.S.I. 3/4"-16 thread ports. **\$12.95**

VALUABLE GEARS BARGAIN SPEED REDUCER 5:1 or 10:1 ratio. 90 post degree angle rated 2 H.P. **\$6.45** post paid

DILUTOR DEMAND PRESSURE REGULATOR. 1800 P.S.I. Gov't. Cost **\$6.45** post paid \$80.00 #A-12

MODERN LAWN MOWER SHARPENER

Service departments of leading Lawn Mower manufacturers use the Modern Lawn Mower Sharpener. One lever moves lawn mower into grinding position. Gasoline and oil remain in engine while sharpening, no dismantling of wheels, roller or handle. The Modern is a precision bed knife grinder—no extra grinder to buy. Imitated but never equaled—Compare before you buy. If it isn't a Modern it can't be Modern (Prices subject to change without notice)



WRITE FOR FREE BOOKLET 100 **\$263.00** with motor F.O.B. PASADENA

MODERN MFG. CO. 160 N. Fair Oaks - Pasadena 1, Calif.

NOW FINISH LEATHER like an EXPERT with Fiebing's DYEING and REFINISHING KIT

Create your own fine leather gifts. Add a rich lustrous professional finish with Fiebing's Leather Refinishing Kit. Contains 9 basic preparations — everything you need for a complete job. Order Now—make your own gifts for Christmas. Complete Kit \$3.50 Postpaid

FREE FIEBING'S Handbook on How to DYE and REFINISH LEATHER

ASK YOUR DEALER or write direct **FIEBING CHEMICAL CO.** 516 South 2nd St. - Milwaukee 4, Wisconsin

Get This NEW Catalog of WOOD AND WOODWORKING MATERIALS

World's Largest Selection of Finest Domestic and Imported Woods... Mouldings, Hardware, Tools, —ALL at LOW MONEY SAVING PRICES!

Your complete wood buying guide and project book. Craftsman is your best, most complete source of finest kiln-dried domestic and rare imported woods, beautiful wood inlays, colorful handings, matched plywoods, embossed mouldings, carved ornaments, new-est woodworking tools, "hard to find" cabinet hardware and fittings... more than 1,500 items! Packed with newest scroll saw patterns, project ideas & money making plans. Enclose 15c (refunded with first order) to help pay mailing, handling cost. Write now!

Craftsman Wood Service Co., Dept. A-410 2727 S. Mary Street - Chicago 8, Ill.

148 PAGES Many in full color packed with rare, fancy & imported woods... veneers, plywoods, patterns, tools, ornaments, hardware... everything for the woodworker.

MAIL COUPON NOW!

CRAFTSMAN SERVICE CO., Dept. A-410, 2727 S. Mary St., Chicago 8, Ill.

Enclosed find 15c. Rush me new Woodworkers' Catalog Handbook.

NAME _____

ADDRESS _____

CITY _____ ZONE _____ STATE _____

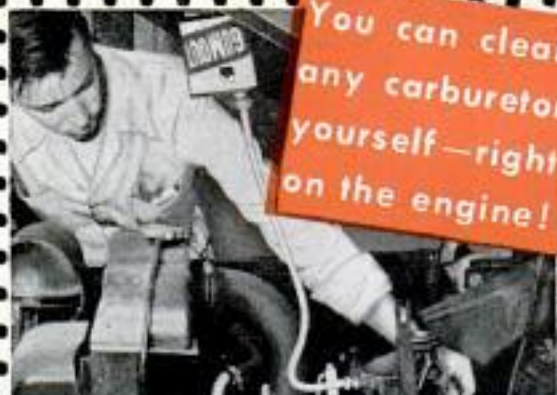

Pouring solvents or "additives" down the throat of a carburetor will not clean it.

GUMOUT forced-flow carburetor cleaning does the job right because it reaches the places that need cleaning most: the idle system, high-speed system, gas and air passages—even those all-important air bleeds. You get immediate improved engine performance...more economical performance.

GUMOUT and KIT, \$3.95 complete.
GUMOUT refills, \$1.50 per pint can.
Sold by leading Auto Supply Stores.

Write today for FREE illustrated 46-page Carburetor Handbook.



GUMOUT DIVISION
Pennsylvania Refining Company
2671 Lisbon Road Cleveland 4, Ohio



HOW TO GET A NEW GARAGE DOOR AT LESS THAN HALF PRICE!

Yes, you can have a swing-up garage door like the one shown here—complete with Stanley Swing-Up Hardware for less than half what you'd normally pay!

How? Build it yourself from Easi-Bild's* Pattern No. 86. It's easy! No special tools—no special skill! Just follow the clear, "can't-go-wrong" directions of the pattern. Tells you everything—including what materials to buy,

where and when to use them. Stanley Garage Door Set is simplicity itself to install. You'll be amazed how quickly you can do the job—and mighty proud of your results.

Ask your dealer for Simplified Directions for Installing Stanley Garage Hardware and Easi-Bild Pattern. Or use coupon below. *Trade Mark Reg. U.S. Pat. Off. — Easi-Bild Pattern Co.

EASI-BILD PATTERN CO., Dept. S-4, Pleasantville, N.Y.

Enclosed is 50¢ in coin, money order, check for Garage Door Pattern No. 86

Please send Simplified Directions for installing () Single () Double Garage Door Hardware.

NAME _____

ADDRESS _____

CITY _____ ZONE _____ STATE _____

owners who participated in our survey are of a different opinion. Only 10 percent said they would prefer a hand shift. Several said they could do better in acceleration runs with the automatic unit.

"The lack of a requirement to shift gears makes it a very formidable machine in a drag race."—Ohio test pilot.

But there were some who said they wanted a conventional transmission.

CHEVROLET CORVETTE SPECIFICATIONS

ENGINE

Type 6-cyl., in-line, OHV
Bore and stroke 3-9/16x3-15/16 in.
Piston displacement... 235.5 cu. in.
Brake horsepower.... 150 at 4200 r.p.m.
Compression ratio.... 8.0 to 1
Transmission Torque converter with gears

GENERAL

Steering ratio (over-all) 16.0:1
Steering wheel (lock to lock)..... 3.9 turns
Turning radius..... 19.5 ft.
Brakes Conventional hydraulic with bonded linings
Tire size..... 6.70x15
Recommended 22 lb. front and rear normal tire pressure..... 28 lb. for sustained high speed
Shipping weight..... 2705 lb.
Wheelbase 102 in.
Tread, front..... 57 in.
Tread, rear..... 59 in.
Height, over-all..... 52.16 in.
Width, over-all..... 72.24 in.
Length, over-all..... 167 in.
Road clearance..... 6 in.

CAPACITIES

Oil 5 qt. (6 qt. with filter)
Water 18.25 qt.
Gasoline 17.25 gal.

INTERIOR DIMENSIONS

Front-seat width..... 57.20 in.
Headroom 35.40 in.
Legroom 41.00 in.

"Unable to shift down satisfactorily with Powerglide."—Michigan pilot.

"Do not care for Powerglide. Slippage component is too much. Powerglide is dragging its feet."—California television producer.

Although the owners agree that the Corvette is a great fun car and, while it may not be in the same league as the Mercedes or the Jaguar, it offers something these cars can't—a dependable, untemperamental engine that can be repaired in any corner garage if it should go bad. One man who has owned Jaguar, MG, Mercedes, Triumph, Austin Healey, Allard-Cadillac and other sports cars described its appeal well when he wrote:

"It combines reasonable sports-car characteristics with comfort and sex appeal, American service and parts. It is better for general use than a foreign sports car, but not suitable for serious competition."

Turn back to page 119 for Floyd Clymer's road test of the Corvette. ★ ★ ★

not just a place to stay! instead

HERE IS THE LOG CABIN RETREAT YOU'VE ALWAYS WANTED... At a price you can afford... the finest... A BROWNLEE SECTIONAL LOG HOME... with all the features you want:

- Select, seasoned white cedar logs pretreated with Acme-Dow sealer against insects, rot and weather.
- Deep groove log and spline construction caulked with mastic compound.
- Rigid factory fabricated wall panels with doors and windows installed.
- Natural log exterior, handsome knotty effect on inside walls.
- All materials needed for erection included... you can build a BROWNLEE cabin yourself... and save... the price... from \$958.00.
- Some dealer territories still open. For illustrated catalog send 25c tax.

- A SUMMER RESORT
- A HUNTING LODGE
- A MOUNTAIN HIDEOUT
- INDEED... A YEAR 'ROUND HOME



UNIVERSAL HOMES INC.
3508 GUARDIAN BLDG., DETROIT 26, MICHIGAN

275 DO-IT-YOURSELF BOOKS-CATALOG FREE

Do-it-yourself books on painting, home repairs and improvements, carpentry, house planning and remodeling, interior decorating, concrete work, gardening, garage building, home workshop, power tools, television, plumbing, electricity, boat-building, automotive repair, hobbies, upholstery, furniture building, photography, etc. Dept. DN-1
Popular Mechanics Press, 200 E. Ontario, Chicago 11

MORE For Your Money in a SHAW "DU-ALL"

Improved design, better value in 1 1/2, 2 1/2, 3.5 H.P. walking tractors. New, low cost, streamlined 2 1/2, 5, 8 H.P. riding tractor. Inexpensive, new 1 1/2 H.P. tiller that pulverizes up to 12 inch swath 6 inches deep, and less. Automotive gears on heavier models. Prices will please you. **FREE CATALOG.** Write today. 4510 Front St., Galesburg, Kans. 6640 N. 4th St., Columbus, Ohio

New Low Prices
Walking Tractors \$99.50 up
Riding Tractors \$299.50 up

SHAW MFG. CO.

SILVER SOLDER TORCH & KIT \$7.95
JOINS ALL METALS PERMANENTLY
Do your own repairing. KIT includes one tube silver solder paste and 12 3-in. lengths silver solder alloy. Heat-test ALCOHOL TORCH known. 2700° F. flame. Operates in any position, indoors or out. Pint of special fuel included. Complete outfit ready for use \$7.95 postpaid. TORCH alone with pint of special fuel \$6.85. KIT alone \$1.65. Instructions included.
AMERICAN PRODUCTS CORP., 422 S. Dearborn, Dept. 3-J, Chicago

VARIABLE SPEED HYDRAULIC POWER TRANSMISSION
It has Infinite Speeds 0 to 550. Reverse. Automatic Overload Protection! Adjustable Torque up to 180 inch pounds. 3/4" Input and Output Shafts. It will handle 1/2 to 1 1/2 H.P. Motor. Case measures 7 1/2" long, 7" high, 6 1/2" wide. **VALUE OVER \$300.** Shipping Wt. 25#. On C.O.D. Orders we require a 10% Deposit. **\$54.50** only Fob. Chicago
DIRZIUS MACHINE SHOP "G" 1423-25 So. 52nd Ave., Cicero 50, Ill.

Say You Saw It in POPULAR MECHANICS

All the Facts You Need About PORTABLE ELECTRIC TOOLS!

New CATALOG! Hundreds of time and money-saving ideas for hobbyists, builders, professional woodworkers! New 28-page catalog describes latest portable electric tools—how they work—what they do—where they save. Explains features and uses of electric saws, belt sanders, orbital sanders, disc

grinder-sander-polisher, routers, planes, shapers, drills, bench grinders, chain saws, hedge trimmers—tool accessories. Shows what to look for when buying electric tools—how to get most value. Write today. Send 10c to cover postage and handling. **Send for your copy NOW!**

PORTER-CABLE MACHINE CO., 2670 N. Salina St., Syracuse 8, N. Y.



WAR SURPLUS AND OTHER BARGAINS SAVE UP TO 90%

HYDRAULIC POWER PLANT

The very latest Air Force type, used wherever hydraulic power or pressure is needed. Any type of equipment up to 2000 PSI. Complete with 24 Volt motor, gear-type pump, 2000 pounds pressure gauge, 5" accumulator with lifetime Purulator filter and storage tank. Set on mounting board, ready to install. Makes ideal portable hydraulic power supply. Parts can be dismantled and used separately for special needs. Shpg. Wt. 55 lbs. Approx. GOVT cost \$475. NEW (in original factory pack)... **\$59.50**

"High-Test" SPEED DRILLS

Complete set of 29 drills from 1/16" to 1/2" by 64ths. Full jobber's length. Wt. 2-1/2 lbs. A \$24.95 value. New. With 1/4" shank—**\$9.95**. With straight shank—**\$6.95**. Complete with case and size markings. Order now!

P1 GENERATORS

Electric Auto-Lite, 200 Amps, 24 Volt, 2500 RPM, Dandy arc welder. Wt. 53 lbs. Approx. GOVT cost \$450. Like NEW. **\$11.50** incl. easy diagram.

MAKE YOUR OWN ARC WELDER Package consists of 1 NEW Auto-Lite P1 generator, 1 giant toggle switch, giant 5.75 OHM Rheostat, 1 voltage regulator, wiring diagram chart showing conversion of Aircraft Generator to Arc Welder. **SPECIAL—\$23.50**

NEW IMPROVED MODEL MAUSER-TYPE PRECISION 1/1000" VERNIER CALIPERS

Quick, handy, accurate. 6" Vernier Calipers. Glass hardened, lapped measuring surfaces. Fine engraved scales—1/1000" and 1/10 mm for inside, outside & depth measurements. Friction thumb release. Larger capacity. Two giv adjustments. Reg. \$25. Anniversary Special only **\$6.95**. Leather case \$1 extra.

GEAR HEAD MOTOR

Use to turn antenna, open or close doors and windows, barbecue, displays, etc. Approx. 1 RPM. Set for 140° turning with limit switches that can be removed for full 360° turning. Operates on 24 Volt DC. 1/2" shaft dia. 3" wide, 10" long. Wt. 4 lbs. High speed 7000 RPM. 1/10 HP motor, micro-switches, reduction gears, mounting brackets—a bonanza for hobbyists. Approx. Govt. Cos. \$90. In perfect condition, now just **\$3.50**. Mfd. by Barber-Colman Company

SENSITIVE ALTIMETER in 10 Ft. Increments. NEW! Famous Pioneer 0 to 35,000 ft. (Inches of Mercury). Tested and inspected in our own instrument lab. Guaranteed perfect. Approx. Govt. Cost \$150. NOW ONLY **\$12.95** PREPAID!

MICROMETERS Chrome plated, precision engineered, carefully tested to give long life. All new 0-1" cap. **\$2.25** ea., 1-2" cap. **\$3.50**.

Send 25¢ for big catalog. Bargains for everyone. Check, Money Order or Cash. 25% deposit on C.O.D. orders. Prices F.O.B. Culver City, Calif., unless otherwise stated.

AIRBORNE SALES CO., INC. DEPT. PM1054
8501 Stellar Drive, Culver City, Calif.



TRU-PERIMETER HEATING

The leading hot water base-board heating. For new homes or old. Folder on request to Dept. PM10, Warren Webster and Company, Camden 5, N. J.

Webster
TRU-PERIMETER FORCED HOT WATER
BASEBOARD HEATING

HERE'S YOUR COMPLETE POWER TOOL WORKSHOP

FOR
ONLY

\$7995

FACTORY
TO YOU



- TRY SUPERSHOP FREE
- WE PAY FREIGHT
- YOU BE THE JUDGE
- EASY PAY PLAN

● Why does Power Tools Inc. make such an unusual offer? Our business is manufacturing and selling power tools direct to people like yourself. We have had experience with hundreds of thousands of people regarding their home workshop requirements. Supershop meets these requirements. This has been proven.

The combination of direct selling, advanced design and efficient manufacturing enables us to give the greatest power tool value in America today. That is why we have the courage to make you this offer.

This free trial is truly free. The machine is prepaid to your door and if it does not satisfy you, you return it at our expense. If you keep Supershop you pay the low factory-to-you cash price — or easy payments to fit your budget.

Write for free information. Mail the handy coupon — or send a postcard. We'll mail you colorful brochures on Supershop — and full details on the FREE TRIAL HOME OFFER. Absolutely no obligation.



1/2" DRILL PRESS



8" SANDER



30" LATHE



8" GRINDER

POWER TOOLS INC. 164 YATES AVE.
BELOIT, WISCONSIN

POWER TOOLS INC. • BELOIT, WIS.

Send me your FREE brochures on Supershop and complete information about the Free Home Trial Plan. I am under no obligation.

NAME _____

ADDRESS _____

CITY _____

STATE _____

Corvette Road Test

(Continued from page 119)

top end was not needed even when wide open). The car will do an honest 105. With a rear-axle ratio of 3.55:1, the car almost loaf along at 90.

The tuned Blue Flame Chevrolet valve-in-head engine used in the Corvette develops 150 horsepower at 4200 revolutions per minute and has a high-lift camshaft and a maximum torque of 223 foot-pounds at 2400 revolutions per minute. The engine has three Carter side-draft carburetors and is as lively as a tiger. Mechanical tappets and extra-heavy valve springs are used to permit engine speeds of over 5000 revolutions per minute. A split exhaust manifold, dual mufflers and tailpipes definitely aid in keeping back pressure low. A pleasant but rather loud tone results from straight-through mufflers and dual exhaust pipes. The Corvette engine, with modified valve timing for higher engine speeds, is noisier than a stock Chevrolet engine. Acceleration is terrific and the car takes the average hill as if on level ground. The three carburetors apparently are not easily synchronized, as there was some unevenness and overloading.

The short wheelbase contributes to fast cornering at all speeds. Compared with the average American car, it is more rigid, has stiffer springing and does not roll or sway on corners. Stability is good. The dry shipping weight is 2705 pounds without radio or heater, thus making the weight-to-horsepower ratio extremely favorable—approximately 18:1.

The over-all steering ratio of 16:1 is fairly high for a semisports car. It requires 3.9 turns from lock to lock. Fewer turns of the wheel would be better. The steering action should be faster by about 25 percent for easier, quicker handling, which is necessary in fast cornering at high speeds. The turning radius is 38 feet.

Suspension is very good. Rear springs are wider and longer. They have only four leaves as against seven in the regular Chevrolet. There is some plastic-body shake and steering-column vibration.

Full-bonded brake lining is used. There was no evidence of fading and I rate the brakes excellent—in fact, the car is "over-braked" for its weight, a safety feature. Actually, the brakes are standard Chevrolet, with a slightly larger master cylinder, giving the system 3 percent more effectiveness.

The driving position is very comfortable and I like the angle of the steering wheel. The contour of the bucket seat and back

(Continued to page 362)

FILL IT, FORGET IT...FOR MONTHS!



MoPar Xtra-full battery holds 3 times more water where it counts, above the plates—seldom requires filling!



Requires water only 3 times a year in normal use, thanks to revolutionary new design. Get your MoPar Xtra-full battery from any Plymouth, Dodge, De Soto or Chrysler dealer . . . or from better service and repair shops everywhere.

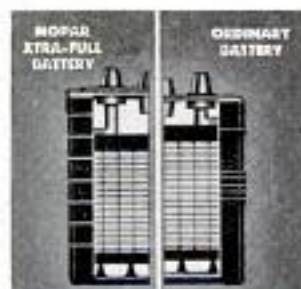

Extra-large reservoir, above plates, means that plates are kept fully covered, to deliver full power longer. Ordinary batteries provide only $\frac{1}{3}$ the reservoir and are more likely to develop inactive plates which cause battery failure.

Extra-large water reserve minimizes battery worries

Here is assurance of *longer lasting* battery power to reduce your service bills . . . and of *full* battery power to spin the coldest engine.

Because new MoPar Xtra-full batteries provide 3 times the water reservoir, *plates are kept submerged* . . . to deliver full power long after the plates in ordinary batteries are exposed and inactive. Also, *extra electrical capacity* and *fibre-glass insulation* prolong battery life even further.

So—to be sure of full battery power that lasts longer . . . make *your* next battery a new MoPar Xtra-full battery!

MoPar is more than just the name of a battery. It is the identifying name of thousands of parts and accessories designed and built especially for your Plymouth, Dodge, De Soto or Chrysler car or Dodge "Job-Rated" truck.

PARTS DIVISION • CHRYSLER CORPORATION

BUILD YOUR OWN POWER TOOLS- WITH GIL-BILT

Exclusive GIL-BILT Build-It-Yourself Features

- No machining—build easily with hand tools only
- No blueprint reading—step-by-step pictorial plans, full scale patterns, actual photographs
- Sturdy wood, aluminum and steel construction
- Capacity and performance of commercial saws selling for \$60 and up
- Proved performance. Nationally advertised and sold for 7 years. Satisfied customers around the world.

PARTS KITS

PLANS only
\$1.00 EACH
POSTPAID

10-INCH TILT/ARBOR SAW

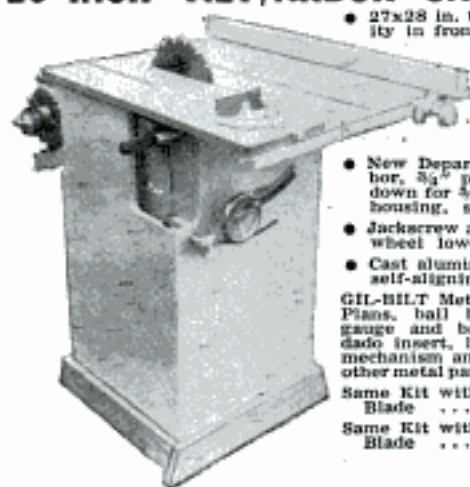

- 27x28 in. table, 13 1/4 in. capacity in front of blade

- 10 in. blade cuts 3 1/4 in. deep, tilts full 45-degree

- Floor model 34" high, table always stays level

- New Departure ball bearing arbor, 3/4" precision shaft turned down for 5/8" bore blades, alum. housing, shipped ready to run

- Jackscrew and 4 1/2 in. dia. hand-wheel lowers and raises blade

- Cast aluminum miter gauge and self-aligning rip fence guide

GIL-BILT Metal Parts Kit includes Plans, ball bearing arbor, miter gauge and bar, rip fence guide, dado insert, lock knobs, jackscrew mechanism and handwheel, and all other metal parts (less blade) **\$22.95**

Same Kit with 10" Combination Blade **\$25.90**

Same Kit with 8" Combination Blade **\$24.90**

12-INCH BAND SAW

- Cuts to center of 24 inch circle
- Handles stock up to 6 inches thick
- 18x18 inch table tilts 45 degrees
- Lower wheel and drive pulley runs on sealed New Departure Ball Bearings; Upper wheel runs on two 5/8" bore Oilite Bronze bearings
- Upper wheel tension and tilt mechanism of cast aluminum, completely assembled
- Upper and lower blade guides. Each has ball thrust bearing, self-lub bronze jaws
- Rigid cast aluminum wheels fully machined ready-to-install. Heavy rubber tires
- Uses standard 78 inch blades up to 3/4 inch wide
- Fully enclosed mechanism for utmost safety

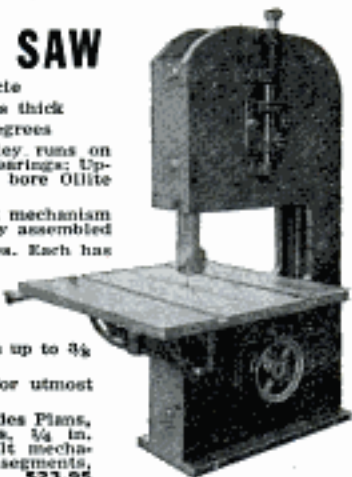

GIL-BILT Metal Parts Kit includes Plans, rubber tires, aluminum wheels, 5/8 in. blade, ball bearing spindle, tilt mechanism, blade guides, table tilt segments, and all other metal parts. **\$23.95**

ALSO AVAILABLE Plans & Parts Kits for 18-in. Band Saw, Belt Sander, Spindle Shaper, 8-in. Tilt-Table Saw

Return Kits in 10 days for refund if not satisfied. For shipments up to 600 miles, add 3%; over 600 add 10%. Amount in excess of actual postage will be refunded. Order Kit now, or order Plans at \$1.00 each and Kit later less cost of plans. Write for FREE Catalog.

GILLIOM POWER TOOLS P. O. Box 1-PK, Lambert Field St. Louis 21, Missouri

Get Our Big Manual of "HARD-TO-GET" ITEMS

For home craftsmen, wood workers, industrial art departments, furniture repair men, hobbyists, cabinet makers, etc. Send only 50c today for your copy.

A few of the items we sell: Inlays, fancy cabinet wood, lumber, Ebony, Holly, Dimension cut lumber, lignum vitae, Carving Blocks, Turning Squares, 120 kinds of veneers, Abrasive papers, archery woods, bill-board clamps, binswings, bed fasteners, blueprints, Chair braces, brass chain, brass fencing, Craftsmen books, candlestick holders, candlestick sockets, card table hardware, casters, Chair cane, ceramic tiles, clamp nails, crib hardware, Dowels and dowel pins, dowel centers, drawer rollers, felt, Flok finishes, foam rubber, furniture clamps, complete professional finishing materials, Folding tablelegs, hand tools, furniture pulls, modern and period, chest and ornamental hardware, all types of hinges and locks, small box hardware, inlaid picture kits, inlaid card table legs, leather working tools, Micarta, revolving Lazy Susans, musical movements, moulded wood carvings, Metalcraft material, Moss Sander, nut bow hardware, Picture frame moldings, Pro Cut Wood Pix, perforated steel panels, plaster standaris, plastics and plexiglass, internal carving bits, plastic polishing compounds, Electric routers, sanders, foot rheostats, hand drills, sprayers, revolving fixtures for television tables, chairs, etc. Fibre rush, screw hole buttons, spiral saw blades, sliding door track, sharpening stones, home owners specialties, 109 woods, ski woods, platform rocker springs, Table leaf supports, tack rags, thermometer cards, turned furniture legs, typewriter fixtures. Complete upholstery supplies, Veneer presses, wood burning pens, wood working instructions, black and copper wrought iron hardware, zigzag wire.

Send fifty cents today (refunded on 1st order) for your copy of the Country's leading Catalog, "Constantine Manual for Craftsmen" to:

ALBERT CONSTANTINE & SON, Inc.
Dept. PM-10 797 East 135th St. New York 54, N. Y.

cushion is excellent. It fits the body better than a conventional car seat.

During my test there were bothersome gas fumes seeping into the cockpit.

The folding top could be improved. There were water leaks during a rainstorm. Also, the side-curtain arrangement is poor. Some sort of roll-up curtains or disappearing side windows would be an improvement.

The top can be raised in about five minutes with practice. When down, it is packed under a hinged cover behind the seats.

The doors should open wider, and the operating locks could be improved. The hood opens from the rear and is locked by two latches, one on each side of the cowl.

Like most sports cars, it is a little difficult to enter as the cowl extends quite far back.

Corvette is available only with Powerglide automatic transmission (with slight modification) and has a short shift lever in the floor at the right side of the driver's seat. If the throttle is held open, upshift takes place at 4500 revolutions per minute or about 55 miles per hour. Downshift below 48 miles per hour can be had by depressing the throttle and the car leaps forward with vigor.

Of course, most genuine sports-car lovers think a clutch and shift lever are necessary and do not like automatic transmissions. The Corvette, however, is not a true sports car. It definitely is not the type of sports car to be used in competition, although some Corvette owners report competition successes. (Only 18 percent of the owners belong to a sports-car club or group.) Acceleration is terrific even with the automatic transmission. Acceleration is faster from a standstill than the average driver could attain in the same car with conventional transmission. High performance does not lend itself to economy and the Corvette's three carburetors are not economizers. With the car just "begging" to be gunned, one is often inclined to forget economy anyway.

Both bumpers should be larger to afford more protection in traffic and parking. The 167-inch length makes for easy parking and the height of 51 1/2 inches at the windshield makes it a low, well-balanced car for high speeds and adds to its sleek appearance.

The Corvette body consists of a laminated construction of glass fibers impregnated and bonded by a clear plastic which when an activator is added, sets itself into a solid panel rather like plywood. The result is a very usable body, somewhat expensive, but of light weight. It stands up to abuse, will not rust, will not crumple

(Continued to page 364)

MORE RAILROADING REALISM!



NEW Fairbanks-Morse Type Diesel.
A real powerhouse with two motors
and *Magne-Traction*. 17" long.

LIONEL TRAINS

WITH MAGNE-TRACTION

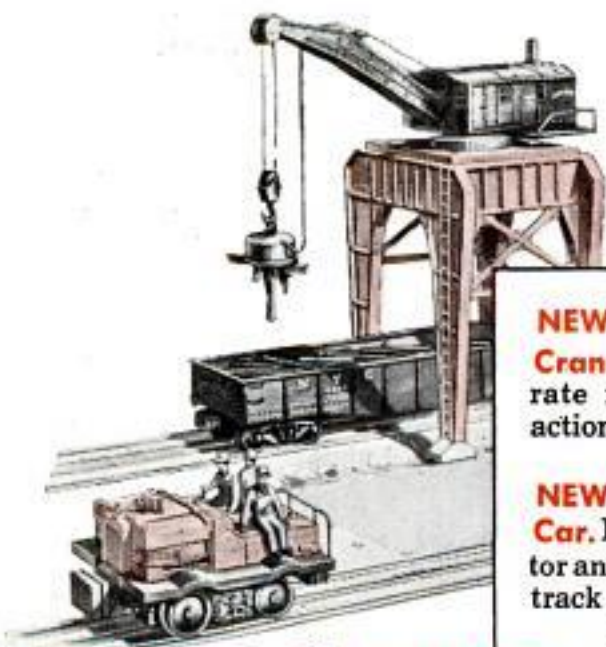

Scale detailing that reproduces not only the appearance but the action of the real thing . . . that's part of Lionel's undisputed leadership for over 50 years. Lionel Trains *look* and *act* the part! So do famous Lionel operating accessories. Only Lionel locos have *Magne-Traction* for speed, pull, climb and control. Real R. R. remote-control knuckle couplers on every car. See the newest of the world's finest trains at your Lionel dealer's.

NEW Portal Gantry Crane. Three separate remote-control actions!

NEW Section Gang Car. Has its own motor and operates from track power.

SPECIAL COUPON OFFER!

LIONEL TRAINS, Post Office Box 9, Dept. Y
New York 46, N. Y.

I enclose 25¢. Please send me special Lionel Train catalog offer, postage prepaid.

1. The new 44-page full-color Lionel catalog.
2. The new 5½" double-faced record of whistles, bells, railroad sound effects and Diesel horns.*
3. Lionel's special "Pop Persuader."

Name _____

Address _____

City _____ Zone _____ State _____

*Plays on all 78 RPM phonographs except some spindle or automatic changers.

"500" WINNER PRAISES MONRO-MATIC SHOCK ABSORBERS

BILL VUKOVICH,

"500" winner 1953 & 1954

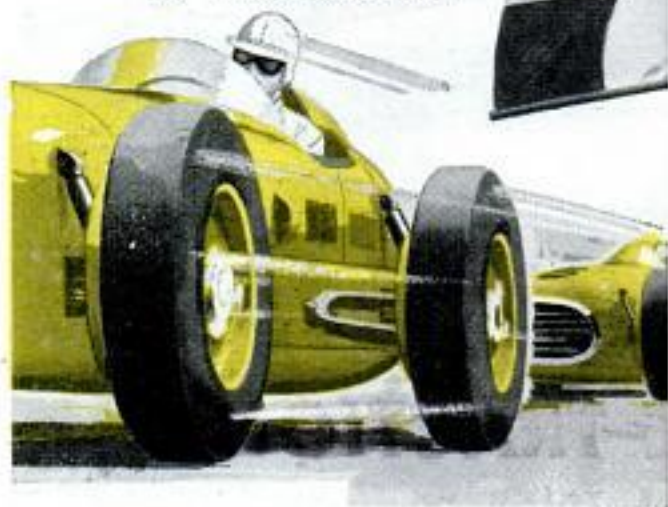

"We give a great deal of credit to the *Monro-Matic Shock Absorbers* that were on our car during our record-breaking run in the 1954 Indianapolis '500.' The added stability and control which they contributed, especially through the curves, gave us complete confidence. These great shocks are standard equipment with us."

Bill Vukovich
Driver

Jim Travers
Mechanic

What *Monro-Matics* do for Bill Vukovich's famous race car, they will do for your car. By automatically adjusting to every road and load condition, *Monro-Matics* give you better traction, more riding comfort, more all-round driving safety.

Now you can try *Monro-Matics* on your own car under Monroe's money-back guarantee. Ask your dealer, service station or garage about the Monroe 30-Day Free Ride Plan.



Send 10 cents for new Shock Absorber Manual. Tells the right shock for every car, gives instructions for removal and installation of Direct Action Shocks.

MONROE AUTO EQUIPMENT CO., Dept. M
MONROE, MICHIGAN

in a collision, will take a paint finish and is relatively free from drumming noise.

I really "beat" the Corvette over all kinds of high, mountainous terrain and winding roads. It is a fascinating car and a lot of fun to drive. It appeals to many buyers who are not the least bit interested in competition (only 8 percent have used their Corvettes in competition.) It might well be compared to the Mercer Raceabout, Stutz Bearcat, Kissell Gold Bug and the Auburn Speedster of bygone days in that, like these, it is a flashy car for everyday use and not a sports car designed especially for competition. Corvette is definitely a compromise—a semisports car. A lot of people think they want a sports car as they are interesting cars to operate and enjoy, but many lose sight of the fact that sports cars have limited luggage space, afford little protection from weather and require more work than the average American likes to do to raise the top and attach the side curtains, especially in event of a quick rain.

We've heard much about sports-car popularity in the United States but even with the most popular imported sports car (MG), sales amounted to only 7000 last year. It must be remembered that this total is about 1½ days' production of the regular Chevrolet cars—and Chevrolet produces about as many cars weekly as the 32,000 total sports cars imported into the United States last year. So perhaps the market is not so large as some think. Corvette production has been cut back from 1000 to 300 a month so apparently Chevrolet is finding this to be true. ★ ★ ★

Adjustable Polarized Glasses



You can control the angle of the polarized screen in a pair of English glasses. Adjustable from a central position to 45 degrees on either side, the glasses allow you to match the polarization with the angle from which the glare is coming. For 3-D movies, the right lens is set at the extreme right, the left lens at the extreme left. A small stud on the inside of each lens controls position.

SHOP BY MAIL and SAVE at GROBAN'S

HUGGED!! 25 TON MASSIVE!!

CAPACITY HYDRAULIC CYLINDER

- ALL STEEL CONSTRUCTION
- 8" BORE—15" STROKE
- DOUBLE ACTION



ITEM #1815

- 50,000 LBS. PRESSURE WITH 1000 P.S.I. PUMP OUTPUT.
- UP TO 70,000 LBS.—CAPACITY ON INTERMITTENT SERVICE.
- SOLID STEEL 2 1/2" PISTON ROD
- 1" PORTS
- OVERALL DIAMETER—10 1/2"
- DISTANCE BETWEEN CENTERS—28 1/4" CLOSED—43 1/4" OPEN.

IDEAL FOR:

- HYDRAULIC PRESSES • DUMP TRUCK HOISTS • TD-18, TD-24 INTERNATIONAL HARVESTER DOZERS AND GRADERS • LEVELING RAMPS • INDUSTRIAL MACHINERY • ROAD MACHINERY • FARM MACHINERY • HYDRAULIC TAIL GATES

Replacement cost—\$300.00. Shipping Wt.—185 lbs. SPECIAL PRICE

95.00

D. C. ARC WELDER

NEW MODEL 353

ITEM #65 For Stationary or Portable Use. **HEAVY DUTY RANGE TO 250 AMPS.**

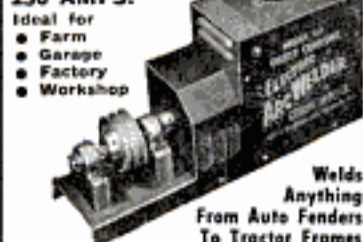

- Ideal for:
- Farm
 - Garage
 - Factory
 - Workshop

Welds Anything From Auto Fenders To Tractor Frames

- Dial Type Rheostat Control
- Use 1/16" to 1/4" Rod
- Generator-type Welder
- Reactor Coil for Smooth Even Arc
- Use 7 1/2 H.P. Electric Motor or 10 H.P. Gasoline Engine
- Run at 2500 R.P.M.
- Available with Either Flat Belt or Double V Pulley
- Complete Operating Instructions

Shipping wt. 107 lbs. Deluxe Model—with "Magne Terminal" for low amperage range welding. (Between 10-100 amps.) F.O.B. Chicago.....

119.50

TO PLACE PHONE ORDERS CALL WEBSTER 9-3793

FREE FALL & WINTER EDITION
1954 CATALOG. 52 PAGES, check-out of unsurpassed War Surplus Equipment Bargains for Farm, Home, Factory, Workshop. Write letter today.

ALL ITEMS BRAND NEW UNCONDITIONALLY GUARANTEED

GROBAN FOUR-WAY OPEN CENTER HYDRAULIC CONTROL VALVE

ITEM #126—Four-way open center control valve, with built-in adjustable relief valve factory set at 1000 P.S.I. Spring loaded neutral position. For use with one double acting cylinder. In neutral position cylinder is locked and pump unloaded. Can be used as single unit or mounted in series. Has 3/4" pipe thread inlet and outlet. 1/2" pipe thread cylinder ports. Finger grip handle. Ship. wt. 10 1/2 lbs.

AN OUTSTANDING BUY! F.O.B. 21.50
Chicago

BERRY — HEAVY DUTY HYDRAULIC PUMP or MOTOR

ITEM #166—use on road machinery, vibrators, paper mills, wire reels, hydraulic presses, speed control units. Ball bearing construction, balanced cam design assures high efficiency performance. When used as a pump delivers 8 G.P.M. 1000 P.S.I., 3 H.P. At 1200 R.P.M. as a HYDRAULIC MOTOR: Rated up to 12 H.P., up to 2400 R.P.M. Standard 3/4" pipe thread ports. 3/4" shaft with keyway. Dimensions: 1 1/2" x 8" x 7". Weight 63 lbs. Regularly \$212.00. OUR SPECIAL PRICE

59.50 F.O.B. Chicago

BRAND NEW SELF-PRIMING ALL BRONZE & MONEL GEAR PUMP

ITEM #383 — USE FOR:
• Sprinkling • Irrigation • Insecticide Spraying of 2,4-D, DDT, Chlordane, Sulphur Compounds, etc. • Sump Pump • Fuel Transfer • Home Water Systems • Dewatering • Salt Water, Chemical, Acid Pumping.



FEATURES: • Needle Bearing Construction • 1 1/2" Pipe Thread Inlet, 1 1/2" Hose Outlet • Standard 3/4" Keyed Shaft • All Bronze Body, Monel Shaft • Extra Drain Cock and Grease Cup • Extra Drive Gears for long, trouble free service.

CAPACITY: From 10 to 80 Gal. Per Min. At Speeds from 550 to 2400 Rev. Per Min. Using from 1/2 to 6 Horse Power. For Pressures to 60 lbs. U. S. Navy Cost \$168.00 Ship. Wt. 58 lbs. F.O.B. Chicago.....

39.50 Ex. Two for 75.00

HEAVY DUTY 12 VOLT D. C. GENERATORS

ITEM #99—For trucks, autos, marine equipment, construction machinery. 12 Volts—50 amps.—6 bolt mounting flange—spline shaft—life time grease-sealed ball bearings. Mfgd. by Leece-Neville. Acq. cost \$185.00. NOW ONLY . . . F.O.B. Chicago.....



16.50

GROBAN SUPPLY CO. Dept. PM-10
1139 S. WABASH AVE., CHICAGO 5, ILL.

GROBAN HYDRAULIC SPEED REDUCER



ITEM #115
2 1/2" x 1 1/4". Gov't acquisition cost \$428.00. Ship. wt. 31 lbs. Complete with 2 qts. of oil and full instructions. F.O.B. Chicago.....

54.50

BRAND NEW! JUST RELEASED! BLACKHAWK HAND-HYDRAULIC PUMP

ITEM #82. Perfect for Hydraulic Presses, Snow Blows, Farm Wagons, Jacks and Farm Pumps. A few easy strokes of the 20" handle and you can lift 5000 lbs., using a 2 1/2" bore — Hydraulic Cylinder. Blackhawk Model P-151 —complete with built-in oil tank and relief valve. Rated 1200-8400 lbs. per square inch. Dim.: 9"x7"x6". Ship. wt. 35 lbs. Worth much more. F.O.B. Chicago.....

22.50



ITEM #41C1C • 2" Bore • 6" Stroke • Double Acting • All Steel • 3/8" Pipe thread ports. Lift capacity 3100 lbs. with 1,000 P.S.I. line pressure. Ship. wt. 12 lbs. F.O.B. Chicago. Price ea.....

12.50

PORTABLE ELECTRIC LIGHT PLANT

ITEM #334
Compact Electric Plant suited for small homes, cabins, campers, hunting and fishing camps, trailers and small electrical home appliances. Operating cost: About 5c per hour. Sturdily constructed for dependable service. Net weight only 88 lbs. Can be carried from place to place, or transported in trunk of car. 250-350 Watt—110 Volt—D.C. Model PE-77D. Powered by easy starting 1 Cylinder, 4 Cycle Briggs-Stratton Engine complete with muffler, starting rope and oil bath air cleaner, direct coupled to a 250-350 Watt Generator with twin plug-in outlets. Engine speed 2650 R.P.M. Shipping Wt. 110 lbs. Commercial List Price \$225.00

WAR SURPLUS PRICE
Special Value **75.00** F.O.B. At Only Chicago

OTHER SIZES IN STOCK FROM 350 W. TO 25,000 W.

ORDER DIRECT FROM AD SATISFACTION GUARANTEED
Send Payment Or Purchase Order Today

Say You Saw It in Popular Mechanics



BRONZE FOUNDRY

Schools and Home Workshops

Make your own castings of aluminum, copper, bronze, silver. Foundry sets are available in three sizes including 2400 Deg. F. blast Furnaces. \$22.50; \$29.50; and \$42.00. f.o.b. Kansas City. Free Circular.

KANSAS CITY SPECIALTIES CO. P. O. Box 6022, Dept. P-10 KANSAS CITY, MO.

OCTOBER 1954

365

AUTOMATIC

MAKES NEW PROFITS

RETOOTHER

for HAND SAWS

Cuts new teeth in 50 seconds — only size 4 to 16 points. Old teeth fall off on chips. Easy to operate. A perfect job.



BURR MFG. CO.

8933 VENICE BLVD. LOS ANGELES 34, CALIFORNIA

Monsters on Parade

(Continued from page 101)

all her machinery and fired guns hidden in her back. The shells consisted of pieces of candy attached to six-inch parachutes.

Just as spectacular as Hazel was the space ship. This marvel from another world weighed more than 10 tons and was 60 feet long.

The space ship, oddly enough, was built around a popcorn ball. Members of the committee decided, first of all, that they wanted to give something away to the kids in the crowd. They measured the parade route and calculated they'd need one popcorn bullet per foot on each side of the route. This meant they'd need 10,000 popcorn balls. They then sat down to plan a vehicle that would hold and fire that volume of ammunition. The space ship was the result.

On each side of the ship was a blister with six lights that were tripped in succession by a switch, producing the illusion that the ship was moving at interplanetary speed. A jet shot out the rear, accompanied, as one worker said, by sounds of "disintegration and atomic discombobulation."

Every minute or so a robot man would pop up out of the ship, his antennas glowing, head and arms moving as he checked the guns and the effect of the bombardment.

Built into each side of the ship were four rocket guns that fired popcorn balls automatically at the rate of 312 each minute over the entire parade route. Every time the eight guns fired, eight long fluorescent tubes beneath the barrels flashed. Spectators were sure that somehow those magicians at General Electric were managing to fire popcorn balls out of lighted fluorescent tubes!

Skilled workers donated a total of 3590 man-hours of their free time to build the space ship, which had an actual parade life of only a half hour. But ask the kids of Pittsfield whether the sight was worth the effort and their eyes will gleam like disintegrator guns. Ask the sweeper who told the executive how to go about building the papier-maché clouds and he'll tell you the boss is interested in fishing and raking his lawn and bragging about his kids the same as anybody else.

Right now, in the General Electric shops at Pittsfield, they're dreaming up some new floats for this year's parade. No telling what they'll be. Residents of the town can't believe that Pitt the Dragon, Hazel the Witch or the space ship can be beat. Members of the committees are just keeping mum—behind some mighty mysterious smiles.

★ ★ ★

SAVE UP TO 85% ON GOVERNMENT SURPLUS

NEW SURPLUS

TOP QUALITY

DRAFTING MACHINE



\$150 VALUE

A precision-built Drafting Machine for draftsmen, Engineers, Artists, Navigators, etc. This fine machine has been precision converted from an

Air Corps Navigational Plotting & Drafting Machine. It has a 90° check for use with all Standard drafting

machine scales. Sturdy 18" arms rotate on double-sealed lifetime ball bearings. Graduations on the vernier hub are from 0 to 360° in 1° increments. Locks in any desired position. Bonds are of K-Metal metal. Compares to instruments costing to \$130.

49.95



MAGNI-FOCUSER

Has fine ground lenses of optical glass. Neutralizes eye strain from close work. Twin lens, binocular design gives third dimension vision. Allows freedom of both hands. Can be worn over glasses. Ideal for gunsmith, diamond, artist, etc.

MAGNI-FOCUSER SIZES

focal length	power	price each
20"	1½x	1050
14"	1¼x	
10"	2¼x	
8"	2½x	

IMPORTED 7PC. DRAW KIT

Only 329



A bargain for the student, draftsman, architect, etc. Has a 4-1/2" divider, a 4-1/2" compass with pen & pencil parts, a 3-1/2" reverse bow compass for pencil and ink, a 4-1/2" ruling pen, capsule of extra leads. All in a velvet lined case.

NEW PLASTIC ELLIPSE SET



A set the artist or draftsman should not be without. Draw perfect ellipses every time. Has projections of 20, 30, 45 and 60 degrees. Ellipses range from 3/8" to 3-3/4" on a major axis. Size: 4½ x 9½"

675



30-45-60 POWER POCKET MICROSCOPE

For Rockhounds, Prospectors, etc. Specially made for and imported by us. Has precision ground & polished lenses. Moisture proof. With 30, 45 and 60 power adjustable magnification.

375



AMAZING NEW MICROSCOPE TELESCOPE

A new optical development. A pocket size Microscope-Telescope. When closed it serves as a 50 POWER Microscope, when opened out it acts as a full 10 POWER Telescope. Only inexpensive Japanese labor can make this price possible.

439



200 PSI OIL PRESSURE GAUGE

Made by Marshalltown Mfg. Reads 0 to 200 PSI. Has a 3-1/2" white face. Has 28" hose with fittings. Steel case.

295

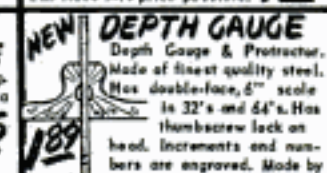

NEW DEPTH GAUGE

Depth Gauge & Protractor. Made of finest quality steel. Has double-face, 6" scale in 32's and 64's. Has thumb screw lock on head. Increments and numbers are engraved. Made by Millers-Polls or Unica, A \$4.00 VALUE.

189

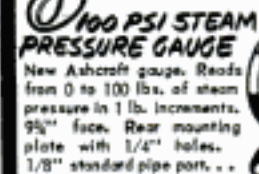

100 PSI STEAM PRESSURE GAUGE

New Ashcroft gauge. Reads from 0 to 100 lbs. of steam pressure in 1 lb. increments. 9½" face. Rear mounting plate with 1/4" holes. 1/8" standard pipe port.

695



BOLD KNIFE AND CASE

Made of top quality steel. 15" long. Ideal for cleaning brush, etc. Comes complete with sturdy belt sheath.

198



CENTRIFUGAL PUMP & MOTOR DELIVERS UP TO 700 G.P.H.

Excellent for draining cellars, rock garden waterfalls, fish ponds, sumps, water circulators, evaporative coolers, etc. Powered by the famous G.E. 110 volt, 60 cycle motor. Has 1 inch standard pipe inlet - 3/4" to 1 inch hose outlet.

A Government Surplus Bargain. Completely Reconditioned. Motor rewound and checked for serviceability. Ready to run. Satisfaction guaranteed. A \$20.00 VALUE

995

OFFICERS LENSATIC COMPASS

An all-purpose, precision instrument for the hunter, hiker, surveyor, prospector, etc. Use for map orientation, for taking an azimuth reading or as a guide on unfamiliar terrain. The bezel ring is marked in 3° notches and rotates through 360°. Has a "peep" sight and hairline guide in lid for taking a bearing on distant objects or landmarks. A \$5.95 Value



395

HY-SCORE .22 CAL. AIR RIFLE

Made in Belgium for Hy-Score. Needs no pumping, just cock and fire. Has ALL STEEL fully rifled barrel, 17½" long. A beautiful natural finished, hardwood stock. Shoots .22 cal. pellets or darts. An excellent training rifle. Ideal for indoor or outdoor use. Length 40½". Weight, 5 lbs.

SAVE 800

1800 VALUE

1095

TERMS SEE OUR AD ON OPPOSITE PAGE

VALLEY-5 DEPT PM-6, 2263 E. VERNON AVE., LOS ANGELES 38, CALIF.

PORTABLE WINCH HOIST

LIFTS 1500 POUNDS
Made for U.S. Navy Bureau of Ordnance as a Bomb Hoist. Has a 21 to 1 gear ratio. 40' tubular wire extension with a 3" pulley on the end. Drum has 12 ft. of 3/16" high tensile strength steel cable. The operating handle has a catch brake ideal for "swing about" truck or platform loading. **2750**
A \$125.00 Surplus Value.

2500 LB LIFT HOIST 2950
WITHOUT MOUNT

500 VALVE
We've sold hundreds of these to garages, machine shops, truckers, boat yards and boat owners, etc. Has a 2500 lb. capacity through a 24 to 1 gear ratio. Had bronze worm gear drive. 18 feet of high tensile, steel cable, 3/16" in diam. Originally used as Bomb Hoist.

MOUNTING FRAME 300
Specially designed and engineered for the above winch. Allows an easy universal mount. Frame ONLY

RIGHT ANGLE DRIVE 225
Has direct 1 to 1 ratio through 90° level gears. Drive & take-off shafts are 3/8" diameter. Gears are self-lubricating, hi-speed steel. Ideal for use on power tools, flux drives, etc. Size: 3 1/2" x 2 1/4" x 1 1/2".

180° OFFSET DRIVE 675
For use where tremendous power at low take-off RPM is desired. Drives through a chain of 6 gears, rotating on self-lubricating, hi-speed roller bearings. Has an 85 to 1 gear ratio. Take-off shafts are 3/2" and 3/8" diameter. USED

GEAR BOX 495
The popular "T" drive. Output shafts are at right angles to input shaft. Ratio is 1 to 1. Shafts are 3/4" dia., & are full bearing mounted. Has 3 1/2" sq. flange mount.

GEAR BOX 595
Angle drive type with 1 input and 2 output shafts. Output shafts have universal joint fitting. Input dia., 1 1/2". Gear ratio is 1 to 1. Full bearing mounted. Overall size: 10" x 6" x 4". Mounts with 4, 1/2 x 4" bolts.

6 PC. TUBE BENDER SET 249
For bending copper, aluminum and other thin wall tubing by hand. Of special spring wire coil. Cadmium plated. Set includes sizes for 1/4", 5/16", 3/8", 7/16", 1/2" and 5/8" tubing. A \$5.00 value.

AMAZING 100-200-300 POWER MICROSCOPE 949
Compares to instruments selling up to \$75.00. Has a triple, revolving turret with 100-200-300 Power objective lenses. These lenses are achromatic - fully precision ground and polished. All-metal body is built to incline through 60°. Has adjustable plano sub-stage mirror. Comes in a handsome, dorretailed hardwood case. Ideal for amateur scientist, student, home lab, schools, etc. Order Today!

DO IT YOURSELF! IT'S FUN! IT'S PROFITABLE!



SAVE AT LEAST 85% TAX FREE!!
REMEMBER - A Dollar Saved Is Worth More Than Two Dollars Earned - because you pay no Income Tax on what you Save when you BUY for LESS. Income Tax is not collectable on what YOU DO FOR YOURSELF - Nor do you pay the hidden tax on someone else's labor savings!!

JOIN THE PARADE!
NOW - for the FIRST TIME - You can Buy Direct from the IMPORTER
GENUINE PHILIPPINE SELECT MAHOGANY PLYWOOD AT LESS THAN WHOLESALE PRICES

SAVE 50% ON LUMBER ALONE
YOU'LL BE FASCINATED By the Beauty, Warmth & Strength of this lovely **LUAN MAHOGANY PLYWOOD**. Its Rich, Golden elegance will enthrall you and you will find upon comparison with your local lumberyard that our special prices on this very beautiful plywood is less than that which most common woods are now being sold for.

Purchased and shipped DIRECT to us in BOAT LOAD LOTS by our overseas offices, we abate HUGE SAVINGS which we are passing on to YOU. This sensational Mahogany Plywood promotion has taken California by storm and now, after months of careful preparation, we are ready to serve the NATIONAL "DO-IT-YOURSELF" movement.

This selected **LUAN MAHOGANY PLYWOOD** is WEATHER and WATER RESISTANT. Bonded with the finest Ureol Formaldehyde Resin Adhesive. Rotary cut for beauty of grain with both sides sanded and ready for use. Face side is unjointed. Ideal for paneling dens, offices, hotels, theatres, etc. Also ideal for the finest cabinet work, furniture, etc. Comes in 2 panel sizes: 4h. x 8h. x 1/4" and 3ft. x 6ft. x 3mm (approx. 1/8") thick. Order TODAY and SAVE!

3ft. x 6ft. x 3mm approx. 1/8" **179**
A \$5.00 VALUE FULL SHEET
Min. Order - 8 Sheets

4ft. x 8ft. x 1/4" 32 sq. ft. **449**
A \$9.50 VALUE FULL SHEET
Min. Order - 4 Sheets

DO-IT-YOURSELF LAWN SPRINKLER SYSTEM

Install your own. All you need is a knife or saw, a spade and the special plastic cement included with each order. System has plastic flexible pipes and will go around the trees, under walks, etc. Dig a trench, thread no pipes - just slit ground with spade, slip pipe in, press seal back attach to water supply & you're ready to go. The system includes 100 ft. of Eastman Kodak "TENITE" plastic pipe - guaranteed for 25 years against rust, rot, corrosion, etc. Also 10 solid brass adjustable sprinkler heads, all necessary fittings, cement and instructions for use. **2995**

NEW GEIGER COUNTER 5050
Strike It Rich! Find Uranium! Here is a fully professional size Geiger Counter that combines lightweight with complete sensitivity to Beta, Gamma, Cosmic & X-Rays - plus extreme ruggedness and simple operation. Has features of the instruments selling at 3 times our price. Includes FREE 120pp. A.E.C. & U.S. Geological Survey book. Has complete instructions on how to operate and how to identify areas.

ARMY PICKMATTACK 129
12" steel head with mottack on one side pick on other. 16-1/2" handle. With carrying case.

ARMY PORTABLE SHOVEL 129
Has 20" hardwood handle. Blade folds to form a pick. G.I. Surplus.

SIGNAL CORPS FIELD PHONE 1495
A private phone or intercom system. Easy to operate. Ideal for use on farms, target range, mountains or forest or any place portable two-way communication is desired. Gives clear reception up to 15 miles. Uses two standard batteries. Set contains ringing generator, leather carrying case and one phone. Several of these phones may be used on one line. Reconditioned and checked out. Price per each phone - only **1495**
Price for a system - two sets... **2950**

AMAZING DO-IT-YOURSELF CATALOG SAVINGS UP TO 85% 320 PAGES - FULLY ILLUSTRATED
Palley's "Gadgeteer's Heaven," the Pioneer in DO-IT-YOURSELF offers you this bargain filled catalog. Contains thousands of Bargains in GOVT SURPLUS - FACTORY CLOSEOUTS and GENERAL MERCHANDISE!
Includes World's LARGEST stock of Hydraulic parts - from a complete hydraulic system to 20,000 cylinders, in 61 sizes and types. Also thousands of items in Hand & Power Tools, Gadgeteers & Hobbyist items of all types, Foam Rubber and how-to-use-it, Cameras and Photo Supplies, Precision Instruments, Microscopes, Outdoor & Sports Equipment, Binoculars, etc.
SEND 50¢ to cover cost of Handling and Mailing - 50¢ credited to your FIRST order!

PALLEY SUPPLY CO
2263 E. VERNON AVE. DEPT. PM-10
LOS ANGELES 38, CALIF

AMAZING DO-IT-YOURSELF CATALOG
Palley's "Gadgeteer's Heaven," the Pioneer in DO-IT-YOURSELF offers you this bargain filled catalog. Contains thousands of Bargains in GOVT SURPLUS - FACTORY CLOSEOUTS and GENERAL MERCHANDISE!
Includes World's LARGEST stock of Hydraulic parts - from a complete hydraulic system to 20,000 cylinders, in 61 sizes and types. Also thousands of items in Hand & Power Tools, Gadgeteers & Hobbyist items of all types, Foam Rubber and how-to-use-it, Cameras and Photo Supplies, Precision Instruments, Microscopes, Outdoor & Sports Equipment, Binoculars, etc.
SEND 50¢ to cover cost of Handling and Mailing - 50¢ credited to your FIRST order!

7" - F2.5 CAMERA LENS NEW-IN-CAN

EASTMAN AERO EKTAR F2.5 coated lens with a 7" focal length. Precision made for Air Corps. Has diaphragm markings from f:2.5 to f:16. Perfect color correction, also ideal for black & white. Complete with heating element, dust cap, clear filter, orange filter and an adapter. A \$200 VALUE **6950**

EXTRA FINE WIRE CLOTH SCREEN
A Super Fine Quality at Less Than Mfr's Cost. Only Gov't Surplus could offer you this value! Ideal for fine strainer work. Absolutely insect proof.

BRONZE CLOTH SCREEN - 32 Mesh - .007 Gauge - 42" Wide. Minimum Order 10 linear feet - Per linear ft. (31 sq. ft.) 55¢. Vol. 296FT Price per roll (100 linear feet) - 2350

MONEL CLOTH SCREEN - (Nickel-Copper Alloy) - 36" wide - 69 Mesh. .0045 Gauge - Minimum 10 linear feet. Per linear ft. (3 sq. ft.) 90¢. Vol. 386FT Price per roll (100 linear feet) - 3350

NEW SURPLUS WADING SUIT 995

Will make Deep Stream and Surf fishing a pleasure. Ideal for use wherever you need to protect the body or clothes from moisture, mud, silt, etc. Made to the finest Government specifications. Was originally designed for use as a Overboard Suit in landing operations. Suit is made of heavy duty rubberized canvas. Has vulcanized seams and built-in rubber gloves and boots. Sizes: Medium and Large. A \$35.00 value

NAVY WADERS 795
Made to top Gov't specifications. of finest quality rubber with warm felt inner lining. Comes up to your chest. Have built-in boots, shoulder straps & vulcanized seams. \$25.00 value. Sizes: Small, Med., Large.

AIR CORPS RUBBER BOATS 395
Made to top Government specifications. Reconditioned & ready to use. Ideal for fishing or duck hunting.
1 MAN 2295 7 MAN 6995
5 MAN 5995 Air Pump 395

FAMOUS HANNA OFFICIAL BASEBALL BATS 129 EA
Made for Armed Services by the countries leading bat mfr. These are regulation size, rugged, straight grain hardwood - made to take it! Available in either hardball or softball bats. Weight 3 lbs. Please include postage.

AMAZING DO-IT-YOURSELF CATALOG
Palley's "Gadgeteer's Heaven," the Pioneer in DO-IT-YOURSELF offers you this bargain filled catalog. Contains thousands of Bargains in GOVT SURPLUS - FACTORY CLOSEOUTS and GENERAL MERCHANDISE!
Includes World's LARGEST stock of Hydraulic parts - from a complete hydraulic system to 20,000 cylinders, in 61 sizes and types. Also thousands of items in Hand & Power Tools, Gadgeteers & Hobbyist items of all types, Foam Rubber and how-to-use-it, Cameras and Photo Supplies, Precision Instruments, Microscopes, Outdoor & Sports Equipment, Binoculars, etc.
SEND 50¢ to cover cost of Handling and Mailing - 50¢ credited to your FIRST order!

how much are
throw-aways
costing you?

replace with

Alum-O-Aire
permanent type
FILTERS

Engineered to last a
lifetime in your warm
air heating system!

for greater economy and efficiency

Here's the filter that's sure to save you money! Eliminate discards forever, improve heating efficiency, cut redecorating costs. Keeps air clean for better health. Check or money order. Shipped prepaid promptly.



Easiest cleaned filter on the market — simply flush with water and replace. No messy oils or adhesives. Absolutely rustproof and fireproof.

Size	1"	2"
10" x 20"	\$7.50	\$8.50
15" x 20"	8.50	9.50
16" x 20"	8.50	9.50
16" x 25"	9.50	10.50
20" x 20"	9.50	10.50
20" x 25"	10.50	11.50

Prices other popular sizes on request.
(Ohio residents add 3% State Sales Tax)

Carey Metal Wool Division
ELECTRONIC ENGINEERING CO.
Dept. PM-2 Springfield, Ohio

**Tough
job?**



It's fast and easy
with your
P & C WRENCH

Tough, special analysis alloy steel takes the heave and likes it. There's a right length for every job — and more jaw surface for a firmer grip. Every P & C Tool is guaranteed — "the BEST tool money can buy". Ask your dealer for the P & C adjustable end wrench!

Buy P & C Tools from this easy-find display. Send 10c TODAY for big P & C catalog. Lists and describes over 500 tools.

**P & C HAND FORGED
TOOL COMPANY**
Dept. H-1054, Box 5926
PORTLAND 22, OREGON



Your most useful shop tool . . .
DESMOND-SIMPLEX VISE



Extra features . . . no extra cost

The Desmond-Simplex Utility Vise is the handyman's "third hand"—for easier, faster work—for sure results, smooth finish. At no extra price, Desmond has extra features: steel slide, enclosed screw, shoulder-fit jaw inserts, pipe jaws (replaceable on larger models), cut-off tool, anvil with horn, 360° swivel, non-pinching type handle. Ask your hardware retailer for a Desmond-Simplex Utility Vise. Write for folder showing vise applications in home, garage, or farm shop.

The Desmond-Stephan Mfg. Co.
173 Walnut Street, Urbana, Ohio

SPECIAL 1/2 PRICE OFFERING! LIVE LATHE CENTER

Ideal for lathes, milling machines, grinders, wood turning

**WITH TIMKEN DOUBLE ROW
TAPERED ROLLER BEARING**

No. 2 Water Taper Shaft • Finest Precision • Lubrication Plug Provided • Grease Seal Retains Lubricant and Prevents Entrance of Foreign Matter • Hardened and Ground 50° Post Removable • TIMKEN Roller Bearing Assembly up to 800 lbs. combined Radial and Thrust Load • 3 1/2" Overall Length • Bearing Housing 1 1/4" x 3 1/4" dia. • Shipping wt. - 2 1/2 lbs.



ONLY
\$14.75
POST PAID
(Reg. 29.50)

Send Check or M.O.
No. C.O.D.

MONEY BACK GUARANTEE

Pa. Residents add 1% Tax

SEABOARD INDUSTRIAL SUPPLY CORP. 224 W. 11th Street

**MACHINE TOOL RECONDITIONING
& THE ART OF HAND SCRAPING**

— ILLUSTRATED —
SEND TODAY FOR FOLDER DESCRIBING BOOK
MACHINE TOOL PUBLICATIONS, 382 Holly Ave., St. Paul 2, Minn.

Run your power tools from **ONE MOTOR**



CLUTCH PULLEY
and LINE SHAFT SET



FLIP LEVER to engage or disengage belts. Complete set includes 40" line shaft and 3 mounts with 2 1/4" clutch pulleys for only \$14.95 (F.O.B. Los Angeles). Extra clutch pulley add. \$4.95. Order by mail!
A. J. VOS MFG. CO. 451 W. 105TH STREET
LOS ANGELES 44, CALIF.

Easy, Accurate Dowel Pin Alignment
with **KENKRAFT DOWEL CENTERS**

Now—accurately transfer dowel hole locations between mating pieces without mismatch. KenKraft Dowel Centers slip snugly in drilled holes, accurately mark exact centers on

mating pieces, eliminate measurements, assure perfect register. Furnished in pairs for 1/4", 3/8" and 1/2" holes, complete set (6 centers) sent postpaid \$1.00.



Send \$1.00 bill, check or money order today!

KENKRAFT

BOX 596, DEPT. 4
MANHATTAN BEACH, CALIF.



Special Offer! "Bag-O-Dowels"
General assortment—cut sizes \$1.00

GIGANTIC MAIL SALE

WAR SURPLUS EXCESS INVENTORY BANKRUPT STOCK

ARMY POWER PLANTS

New condition. Full guarantee. Perfect plants. Latest models. Shipped prepaid to you.

- Plants 3000-4000-W, 115-V, 230 V, 60-C. Push-button start \$391
- Plants 2000-W, 115-V, 60-C \$289
- Plants 1000-W, 115-V, 60-C \$189
- Generators 7000-W, 115-V, 60-C \$235
- Generators 3000-W, 115-V, 60-C AC with inst. panel, \$169.50
- Generator 3000-W, 115-V, DC. Fine for portable AC-DC tools. Govt. cost over \$105. \$58

AC-DC GENERATORS

● Brand new. General Electric and Bendix dual voltage units. Use for welders, fast battery chargers, lights, stoves, etc. Generates 115-v. 2000-W, 800-c AC, 30-v, 200-amp DC. Govt. cost over \$300.

- SALE \$29.48 Prepaid
- Same as above except 125 amp instead of 200. SALE \$23.91 Prepaid



ARMY WINCH-HOIST

● Amazing value. Lifts 1500 lbs. 21-lb-1 ratio gears, automatic brake, 12-ft. lift. Complete with 3/16" steel cable. Use with or without extension arm. Makes wonderful hoist for garages, rear end swing-around mtg. for trucks, etc. Govt. cost over \$125.

SALE \$27.49 Prepaid

GENERAL MISCELLANEOUS

- Searchlights (60") and Plant \$36,000 \$895.00 F.O.B.
- Giant Air Corps Fresnel Light \$49.50
- Army Tool Box (20"x38"x20") \$21.95
- G.E. Farm Motor 3 h.p. 115v, 60 cyc. \$119.50
- Hip Waders 18ize 10, 11 or 12 \$8.65
- Emergency Air Tank \$14.95

FREE CATALOG! Thousands of items. Tools, electronics, watches, transits, tarps, microscopes, weed spray units, etc. Get finest Govt. items at fraction of original cost.

BURDEN PAYS ALL SHIPPING CHARGES

AIR COMPRESSOR BARGAINS

For painting, cleaning, tires, central territories. Assemble your own outfit. Lowest prices in U.S.

- DeLuxe Kit. Compressor, tank, gauge, regulator, paint gun, fittings. How to build instructions. List \$80. Sale \$45.49
- DeLuxe Outfit. Finest ready to use complete air unit on wheels with gun, reg. etc. (Less motor) \$89.95
- Compressor (1-cyl) \$20; 2-cyl \$52; Govt. Air Tanks \$6.79; Regulators \$2.79; Pop off \$1.95; Pres. gauge \$1.89; Finest paint gun \$9.95; Auto. switch \$4.95.

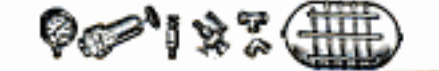

HYDRAULIC SPECIALS

Save to 80%. Build loaders, lifts, etc. Cylinder Buy! Finest leading make. 3" bore, 8" stroke, one way. Fine for plow lifts, etc. List \$25.50. \$11.95

- Cylinders. Two-way, 2"x10" \$22.85; 2"x24" \$28.90; 3"x24" \$39.00. One-way, 2 1/2"x4" \$36.99.
- Pumps. 1000 lb. 12 gal. \$45; Valves. One-way \$18; Two-way \$18; Gauges, 1000, 1500, or 3000 lb. \$3.49.
- Super Special. Cylinder. (Precision) 1 1/2" bore x 4" stroke, Govt. Cost \$87. Sale \$1.95 ea.



PUMPS - VALVES - SYSTEMS

Irrigate. Do it yourself. Our data shows you how. ● Pumps. Centrifugal 1/2" \$19.95; 1" \$28.95; 1 1/2" \$38.60; Rubber impeller self priming 1 1/2" \$15; High-pressure rotary for wood, cattle spraying \$54. ● Water System. Automatic. For lifts to 22 ft. 300 gal. per hr. 40 lbs. 110-V, 60-C, 1/2 hp, motor \$60.50

SPEED REDUCERS - Winches - Hoists

Speed Reducers. Brand new. Worm gear. Force, 6 hp. 1 to 5 ratio. Input shaft 1/2". Output 1 1/2" \$59.50

- Winches. Hand 1000 lb. \$21.80
- Winches. Hand 2000 lb. \$31.90
- Hoists. 3000 lb. chain \$21.95

SPECIAL OF THE MONTH AIR CORPS RUBBER BOATS



● Air Corps' finest new yellow late-type boats. Finest durable reinforced long life construction. Easy to inflate. Fold to very small size, complete with zipper bag. Unused. Perfect. Wonderful for fishermen, floater trips on rivers, swimming pools for kiddies, etc. Govt. cost \$160 to \$500 each.

- 1 to 2-man, \$27.95; 6-man, \$59.95; 20-man, \$98.70.

ELECTRONIC MISCELLANEOUS

- Interested in Electronics? Write for Bull. E-1
- Oak Magneto wall telephones \$9.95
 - W.E. Photo cell (List \$6.50) \$4.95
 - Black Light Tube (4-watts) \$4.80
 - Thyatron Trigger Tube (List \$4.95) \$3.80
 - Army Phone and Test Set \$24.95
 - Portable Ohmmeter (\$21.00) \$9.81
 - Home Appliance Tester (\$51.50) \$12.95
 - Camper's Battery Radio (\$20.95) \$9.91
 - City Wall Extension Phone \$4.99
 - Clock Switch (110-volt 60 cyc.) \$7.95
 - Transformers (110 to 2850-1250 volt) \$16.59
 - Bulbs, 1000-watt, 115-volt Beacom \$8.95

AUTOMATIC REMOTE CONTROL SWITCH



● Amazing complete with dial telephone switch, over a single pair of wires any circuit from 1 to 100 can be selected simply by dialing the number, uncanny response. Fine for intercoms, private automatic telephone systems, experimental, etc. Used but perfect. New cost over \$150. Complete with dial, \$13.95 Prepaid.

ARMY PARTS CLEANER

● Air-turbo solvent cleaner. Makes dirty, greasy parts shiny bright. Wonderful for garages, factories, farms, etc.

- Heavy galv. tank 25"x20"x20". Complete with valve, hose, hydraulic lid lifter. Cost over \$125. \$29.95



We pay all shipping charges. Send for Free Catalog

BURDEN SALES COMPANY

805 "O" STREET LINCOLN, NEBRASKA

AN UNUSUAL OPPORTUNITY!!!!

Famous **MZB** German Precision Calipers AT HALF PRICE



NOW For limited time only

- 30-61 Chrome Steel .001" & 1/128" \$14.00 \$7.00
- 30-64 Chrome Steel .001" & 1/20 mm \$14.00 \$7.00
- 30-62 Stainless Steel .001" & 1/128" \$16.50 \$8.50
- 30-65 Stainless Steel .001" & 1/20 mm \$16.50 \$8.50

ADD 35¢ FOR POSTAGE - NO C.O.D. MONEY BACK GUARANTEE

Genuine Leather Case for above caliper 75¢ each

INTER-CONTINENTAL TRADING CORP. 90 WEST STREET NEW YORK 6, N. Y.

JOINT AND SHARPEN ALL SAWS

SAVE TIME AND \$\$\$



Sensational new Super Filer No. 11 joints and sharpens both hand and circular saws 6" to 10" with all teeth the correct height, depth, pitch and bevel. Easy to use—when file hits hardened steel roller, teeth are finished. Saw runs true and smooth with no side pull. Complete with special 8" file \$9.95 ppd. FREE FOLDER.

"TRU-CIRCLE" saw set. Automatically sets teeth at 10" or more \$2.95. FILE SAWS THE RIGHT WAY



SO EASY with this new filing jig and jointer anyone can now sharpen any hand saw like new! When file hits hardened steel rollers teeth are finished and EXACTLY THE SAME HEIGHT. All teeth cut and saw runs true and smooth. Jig and instructions \$2.95 postpaid. Free Folder. A. D. McBURNEY, 5908 Hollywood Blvd., Hollywood 28, Calif., Dept. D-46

THE NEW DALTON Model D-500 ELECTRIC PORTABLE JIG SAW

7 SAWS IN ONE!

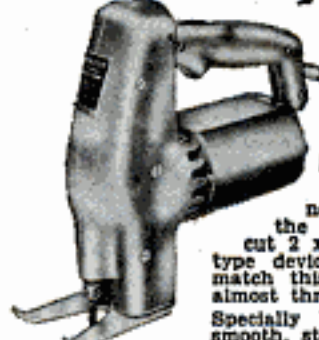

does the work of a RIP... CROSS CUT... COPING... JIG... SCROLL... BAND and KEYHOLE SAW CUTS ANY MATERIAL! SAWS ANY SHAPE!

RIPS and CROSS CUTS 2x4's

Makes fast, smooth cuts... no jumping or chattering. Has the capacity to rip and cross cut 2 x 4's. The only other similar type device on the market that can match this amazing performance costs almost three times as much!

Specially built Dayton motor assures smooth, steady cutting. A built-in compressor blows sawdust away from guide line.

SPECIFICATIONS

● 4 to 1 gear reduction. ● All gears hardened steel. ● Motor exposed for cool running. ● Oilite bronze bearings. ● Air is pumped from top down through the center section, cooling unit as well as blowing sawdust from line.

IT CUTS wood — plastics — metals — Complete with 5 different blades composition boards — hard rubber and \$48.00 others.

IT SAWS circles — curves — straight lines — intricate designs.

SHIPPED ON APPROVAL NO MONEY WITH ORDER — NO C. O. D.

Try it ten days before you buy. If completely satisfied then send \$15.00 and pay balance at rate of \$11.00 per month for 3 months — No Interest or Carrying Charges Added. If not completely satisfied, return to us, no explanation necessary.

KAPNER HARDWARE, INC. Dept. A-117, 2248 Second Ave., N. Y. 27, N. Y.

Please rush one D-500 Jig Saw. I agree to pay \$15.00 within 10 days after receipt and \$11 per month thereafter.

Name _____ Address _____ City _____ Zone _____ State _____

Aladdin 1/4" POWER DRILL TOOL ATTACHMENTS

POWER PLANNER

SAVES TIME AND WORK ON MANY JOBS

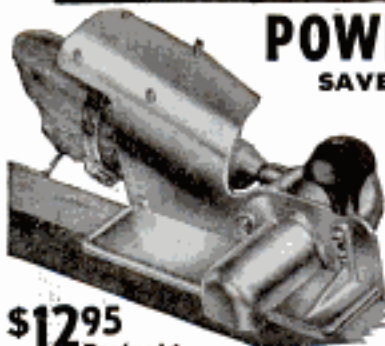

\$12.95
Postpaid

Ideal for fitting doors, screens, storm windows; smoothing rough edges of lumber; handy in cabinet work. Planes wood up to 2" wide.

Exclusive Attaching Feature gives perfect alignment and holds planer and drill firmly together. Changes on and off quickly. Extra

SANDING ATTACHMENT for Planer and 2 sanding drums. \$1.00 extra.

3-IN-1 SAW

A Hack Saw, Jig Saw and Coping Saw in one easy to use attachment. Cuts metal, wood, plastic, hardboard, etc. Full 9/16" chip clearance. No gears, no bearings to wear out. Ideal for sawing in hard-to-reach places. Weighs only 11 oz.

\$4.95 With metal and wood blades (1 ea.). Postpaid

4-HOLE SAW

Cut large holes—quickly, perfectly

Cuts holes 1", 1 1/2", 2", 2 1/2" diameters up to 3/4" deep. The four circular blades slip into grooves of alloy saw body and are firmly held by set screw. A 1/4" drill bit anchored in saw body guides saw blades and prevents tool from "jumping." High carbon steel blades cut wood, plastic and metals.



\$4.95

Complete with 4 saw blades (8 or 14 tooth) and 1/4" drill bit—Specify for wood or metal cutting when ordering. Postpaid.

Every Aladdin Attachment Tool **GUARANTEED SATISFACTORY** or Money Back. Will ship C.O.D. plus postage. Literature available on all attachments. **DEALER INQUIRIES INVITED.**

ALADDIN MFG. CO. DEPT. PM-2, 3125 HARRISON KANSAS CITY, MISSOURI

AIR COMPRESSOR

SURPLUS! NEW Gov. Release!
Original Gov. Cost \$350.00

The Finest 2-H.P. TWIN CYLINDER Industrial Unit Ever Built! Fully Guaranteed
\$1290.00 f.o.b.
200 lb. PRESSURE

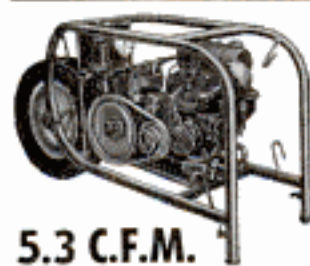

Maintains 40 to 65 lb. pressure for **CONTINUOUS** spraying (no waiting 'til tank keeps building up)

Made by **BENDIX WESTINGHOUSE** to rigid specifications. A BUY for Contractor; Factory; Garage; Service Station; Shop; **FARM! PORTABLE!** Two independent air outlets—one for high pressure (up to 200 lbs.)—the other controlled by regulator from 0 to max. Large face gauge. Adjustable Safety valve. Automatic unloader (adjustable up to 200 lbs.) keeps pressure constant without stopping engine. Welded hollow frame acts as air reservoir... assuring large supply of **OIL-FREE** air with **ABSOLUTELY NO PULSATION!** Sprays with material tanks of any size. Unexcelled for: Spraying; Greasing; Tire inflation; Blowing out heating and refrigeration lines; Small pneumatic tool operation; Insecticide dusting and spraying; Flocking; Undercoating! **SPECIFICATIONS BELOW:**

- COMPRESSOR—**
- Mfr. by **BENDIX WESTINGHOUSE**
 - Twin cylinder
 - 4 Rings on each piston for added compression—capable of pumping 1100 lbs. P.S.I.
 - Forced pressure lubrication assures oil to every moving part
 - Ball bearing construction
 - Capacity 5.3 cu. ft.

- ENGINE—**
- Mfr. by **BRIGGS & STRATTON**
 - Kick or rope start
 - 2 H.P., 4 cycle air cooled
 - Splash lubrication system
 - 2-qt. gas tank
 - Float feed carburetor with adjustable idle speed and automatic governor
 - 3 Piston rings

ALSO AVAILABLE! Same unit with 1 H.P. Electric Motor, \$129.00 Single-phase, 110-220 volts, 60 cy., f.o.b. **IMMEDIATE DELIVERY! SUPPLY LIMITED! ORDER FROM AD FREE Catalog of Motors and Electrical Equipment**
ROBERTS ELECTRIC CO., Dept. P-219, 849 W. Grand, Chicago 22, Ill.

DEPTH MICROMETER EXTENSION BASE

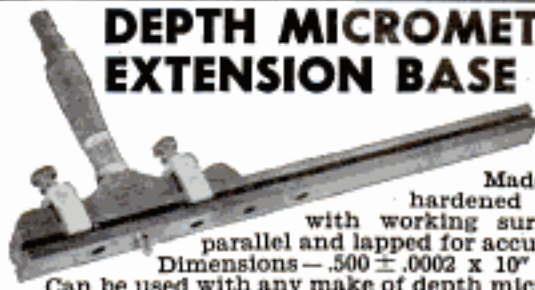

Made of hardened steel with working surfaces parallel and lapped for accuracy. Dimensions—.500 ± .0002 x 10" long. Can be used with any make of depth micrometer. Comes equipped with aluminum clamps and brass screws so will not harm the micrometer. Allows increased use and accurate readings due to more hold-down surface. Extension base has five positioning holes for micrometer.

\$12.95 includes base and clamps
No C.O.D.'s. Send check or money order
GEORGE PORTZ
11035 S. Ruthelen
Los Angeles 47, California

SURPLUS GIGANTIC SAVE UP TO 85%

<p>New Hi-Speed Drills 30 ea. 1/50"-1/4" \$3.50 10 ea. 1/4"-1/2" \$3.50 (Assorted sizes)</p> <p>IMPORTED PRECISION SQUARES Accuracy Blades—Tempered Precision Ground</p> <table border="1"> <tr> <td>2" 1.50</td> <td>6" 2.30</td> <td>Mfr.</td> </tr> <tr> <td>3" 1.70</td> <td>8" 2.80</td> <td>Guar.</td> </tr> <tr> <td>4" 1.90</td> <td>10" 3.80</td> <td>Cert.</td> </tr> <tr> <td>5" 2.10</td> <td>12" 4.80</td> <td>Incl.</td> </tr> </table> <p>8 pc. Comb. Set 2" to 12" 19.95</p>	2" 1.50	6" 2.30	Mfr.	3" 1.70	8" 2.80	Guar.	4" 1.90	10" 3.80	Cert.	5" 2.10	12" 4.80	Incl.	<p>D. C. GENERATORS For Welding P.I. 24V. 200 Amp. \$12.50. R.I. 30V. 300 Amp. \$21.50. P.I. Delco-Remy NEW \$22.50. Guaranteed including Diagram. Perfect</p> <p>NEW ALTIMETERS 0-20,000 Inpr. 200 Ft. \$4.50. Bendix Sensitive 0-35,000 Increment 20 Ft. \$9.95</p> <p>Cat. 15c or Free with Order Check or N.O. 25% dep. on C.O.D. — F.O.B. L.A.</p>
2" 1.50	6" 2.30	Mfr.											
3" 1.70	8" 2.80	Guar.											
4" 1.90	10" 3.80	Cert.											
5" 2.10	12" 4.80	Incl.											

METRO PRECISION TOOL CO. 1907 S. La Cienega
Los Angeles 35, Cal., Dept. M10
Phone: BRadshaw 2-2528

MAGNETS

ASSORTED MAGNETS with big list of handy uses..... 8 for \$1
POWERFUL POCKET MAGNET ideal for testing metals..... \$1
RETRIEVING MAGNET pulls tools, etc., from tank or lake..... \$3
HOT PAD MAGNETS to insert in your own hot pads..... 8 for \$1
BULLETIN BOARD MAGNETS to "pin-up" memos, etc..... 8 for \$1
SLENDER MAGNETS remove chips from drill holes..... 2 for \$1
WE REFUND EVERY PENNY IF NOT 100% PLEASED... POSTPAID
PARK MAGNET CO., 1557 GREENBAY RD., HIGHLAND PK., ILL.

AUTOMATIC CENTERING TOOL



New time saver—money maker for professional and hobbyist metal or wood worker. Assures accurately drilled holes. Compact, simple to operate, centers bar stock—round, square, hex, etc. 2 inch width or less. Equally precise at offset drilling. Invaluable for jigs, dowling and all difficult drilling jobs. Clamp on material—presto—half inch centerline is positioned! Send \$3.95 for practical size. If C.O.D. you pay postage.

"QUICK CENTER", P. O. Box 3126, Inglewood 2, Calif.



OVERLOAD SPRINGS

\$9.95 For cars and trucks. Front and rear. Gives 2000 lbs. extra capacity for all 1/2, 3/4, and 1 ton trucks; 500 to 1000 lbs. extra for all cars except Olds prior to '52 and Buicks. Easily installed. Guaranteed. State make, model.
BRINKMAN MANUFACTURING CO.
2315 Clay Topeka, 134, Kansas

for **STEEL THREADS** in **WOOD**

See your dealer or write direct to:
ROSAN INC., Dept. A
2901 W. Coast Hwy.
Newport Beach, Calif.

KNIFE THREAD INSERT



Here's the answer to countless home repair jobs!

DICKS-PONTIUS Glazing Compound

- A high quality white glazing compound.
- For glazing either wood or metal sash.
- Perfect for many additional home repair jobs—filling cracks, nail holes, etc.
- Easy to handle—never sticky or gooey.
- A truly elastic compound that seals permanently.
- Ready to use as it comes in the can.

Sold by leading hardware, paint and building supplies stores. Always look for the D-P label. It means highest quality in glazing compounds, caulking compounds and putties!

THE DICKS-PONTIUS COMPANY — DAYTON, OHIO
Alexandria, Va. • Decatur, Ga. • Dallas, Tex.

BUILD YOUR OWN ARC-WELDER

We show you how to build NEW powerful welder. No rewinding. Uses most any surplus aircraft generator. Easy to build. 75-300 amps. Complete PLANS 25c. Send today and we'll include FREE our Big War Surplus & Electrical Catalog.

LEJAY MFG. CO., 1247 LEJAY BLDG., MINNEAPOLIS 8, MINN.

ALSO Lowest Price

ADULT'S MOTOR SPORT CAR & CHILD'S 2 Pass. MOTOR CAR

ESHELMAN MOTOR SCOOTER \$149.95

75 miles per gal. Full length 54". Weight 120 lbs. Has puncture proof tires, electric headlight, roomy carry-all, brakes, automatic clutch. Full price \$149.95. Fully guaranteed. Order now. Enclose \$10 deposit, we pay freight. Balance C.O.D. Order now. Esheleman Co., Dept. B-510 109 Light St., Balto-2, Md. 3313 N. Michigan Ave., Chicago-1, Ill. 7070 Hollywood Blvd., Los Angeles 28, Cal. Write for free literature.

2 1/2 H.P. Briggs & Stratton Motor

Protect your home against power interruptions with an...

ONAN Emergency ELECTRIC PLANT

Provides dependable stand-by electricity for heating system, pumps, freezer, lights, appliances. Keeps home safe, livable. Automatic start and stop. Find out how little it costs!

Write for Folder!

D. W. ONAN & SONS, INC.
8582 University Ave. S. E. • Minneapolis 14, Minnesota

A SIZE FOR EVERY NEED
1,000 to 50,000 watts. Compact, quiet-running, easy to install. Gasoline engine powered.

Add-A-Room like this!
DO-IT-YOURSELF
it's easy with Gold Bond Fireproof Gypsum Wallboard



This new room is yours for only \$17 a month!*



Convert your attic, basement or your front porch to a cozy "family" room...with Gold Bond fireproof Gypsum Wallboard. Application is fast—and easy. One panel covers up to 48 sq. ft. Can be sawed like lumber or scored with a knife and snapped off to size. Then, nail to studs or right over old walls. Conceal wallboard joints completely with the Gold Bond Tape Joint Kit and get strong, smooth, seamless walls ready for any decoration.

NATIONAL GYPSUM COMPANY
Buffalo 2, New York

*Cost of materials over 36 months—prices vary in some localities.

Write for Gold Bond How-To-Do-It Plan No. 15. Complete instructions for building the room shown above.

MAIL COUPON TODAY

NATIONAL GYPSUM COMPANY
Dept. PM-104, Buffalo 2, N. Y.

Please send me How-To-Do-It Plan No. 15. Enclosed is 10¢ to cover cost of handling.

Name.....

Address.....

City.....Zone.....County.....State.....



Say "Goodbye" to--

BOILER

Trouble and Expense

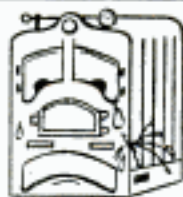

This Year
use famous
**REKO
SCIENTIFIC
PRODUCTS**



SAVE TIME!
SAVE MONEY!
SAVE GRIEF!

FOR HOME AND INDUSTRIAL USE

REKO SCIENTIFIC SCALE SOLVENT Quickly dissolves, completely removes scale, lime, rust, from heating plants and water heating units. Safe, fast, sure. Increases efficiency 20 to 70%. Pays for itself in fuel saved.

REKO SCIENTIFIC BOILER LIQUID BRAZE Guaranteed to permanently repair cracked or leaking steam and water heating systems, piping, radiators. Prevents further corrosion, "red water," rust. 100% mineral.

REKO SCIENTIFIC BOILER CLEANER Cleans interior of entire heating system. One application in fall insures more efficient heating plant throughout year. Absolutely safe for heating units treated for cracks.

Reko Scientific Products proved by 40 years' use. Unconditional money-back guarantee. Simple instructions, easy to use. Saves time, money, grief. Order through your Plumbing and Heating Wholesaler or send your order to us with your wholesaler's name and address. He will bill you direct.

REKO PRODUCTS COMPANY

Manufacturers of quality plumbing and heating specialties—since 1915

5352 BROADWAY DEPT. A-10 CHICAGO 40, ILL.

SAVE \$15 TO \$35



Assemble it
Yourself!

**BIG 10 INCH
POWER SAW
KIT \$14.95**
BUDGET TERMS

\$5.00
Down
\$5.00
Monthly

Why spend \$29 to \$49 for a power saw when you can easily build one yourself with a few pieces of inexpensive lumber and this kit. You get all machined metal parts plus all the screws, nuts, bolts, and washers you need and complete detailed assembly instructions. Make a complete he-man saw that cuts hard or soft woods up to a full 3 1/2 inches thick . . . cuts 2x6s in 2 1/2 seconds. Makes frames, joints, slots, etc. Rips wide or narrow panels, cuts any angle. Cuts joists, siding, rafter. Build and repair furniture and equipment for your home, farm, shop, or office. Table measures 24"x20" and tilts to 45° angle. Only \$14.95 with blade, postage prepaid. Money back guarantee.

Write for Complete Details

YOLANDS PRECISION TOOL CO.
Dept. M.A. 20 Boylston St., Boston, Mass.

AUTOMATIC AIR COMPRESSOR

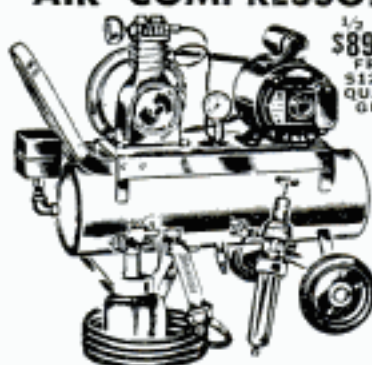

1/2 H.P.
\$89.00
FREE
QUART
GUN

1/2 HP heavy duty R.I. or Cap. motor, 115-V, 60 Cy. AC . . . \$23.50
X2 Quincy 3 CFM, 100-150 lb. compressor . . . \$20.50
Automatic adjustable pressure switch . . . \$6.50
Adjustable pressure regulator and gauge . . . \$6.00

Moisture filter—\$3.25
V-belt drive . . . \$2.75
Hose and tire chuck \$2.50
Safety valve . . . \$1.50
Check valve & copper tubing . . . \$3.75
Small parts shipped parcel post prepaid at above prices.

Complete 1/2 HP unit assembled, ready to use—Plus Special FREE \$12.00 value Quart External Atomizing Spray Gun with every unit . . . \$A-5.
\$99.00 FOB Chicago

Save \$10.00 — 1/2 HP outfit knocked down, you assemble, free spray gun, \$12.00 value. —SK-5 . . . \$89.00 FOB Chicago.
—SK-100 — 1 HP Motor 15x30 Tank Twin Cylinder 9 CFM Compressor, All Access. You assemble. Free Gun . . . \$169.50 FOB
Write for CIRCULAR: Listing Motors; ALL SIZES; Fans and Air Compressors—ALL SIZES.

C. MARSHALL SALES

3546 W. Fullerton Ave. Dept. P-10 Chicago 47

AMAZING TOOL BARGAINS!

75 MOUNTED WHEELS AND MINIATURE CUTTERS \$4.50

Regular \$11.00 Value **\$4.50** Post-Paid
For cutting and grinding on wood, metal or plastic. Includes 26 mtd. wheels and points on 3/32" shanks; 24 miniature cutters on 3/32" shanks; 25 short shank min. cutters. Will fit all electric drills and hand grinders.

12 MOUNTED WHEELS and points on 1/4" Shank. \$2.95

Regular list Value \$8.40. **\$2.95** Post-Paid
26 Mounted Wheels \$7.50
For grinding on plastic, wood, soft and hard metals.

12 Mtd. WHEELS on 1/4" SHANK \$3.60

18 MOUNTED POINTS ON 3/32" SHANK \$2.50

SCHUPACK SUPPLY CO., 7331 Cottage Grove, Dept. M-60 Chicago 19, Ill.

NEW ILLUSTRATED CATALOG 10c

SURPLUS SALE



\$39.50 NEW TOOL POST GRINDERS
REGULAR PRICE \$125.00

1-6 H. P. MOTOR
TAKES WHEELS UP TO 1 1/2" x 4"
EXTRA GULL EXTERNAL OR INTERNAL \$19.50

MONEY BACK GUARANTEE

EDWARD J. NOLAN, PULASKI, NEW-YORK



TERRIFIC VALUES

"DO-IT-YOURSELF" TOOL KITS
ON SALE AT YOUR LOCAL DEALER
The RUGOL CO., New York 13, N. Y.

Say You Saw It in Popular Mechanics

BARRON Drill Press TOOLS



ROTARY PLANER

Planes • Rabbits
Tenons • Panels
Routs • Bevels

Only \$8.50 COMPLETE

FOR WORKSHOP AND INDUSTRIAL USES . . .

Over 40 precision built woodworking tools and accessories . . . Hi-Speed Router Bits—Rotary Surface Sanders & Drum Sanders—Safety Shaper Cutters—Dovetail Cutters—Large Auxiliary Metal Tables—All Metal Shaper Fences—Spindle Adapters—Handy Bench Vises. Many other items indispensable for accurate, useful, versatile workshop use. Every tool sold on complete satisfaction or your money back. See your Barron Dealer. Ask for special folder — "24 Extra Uses for Your Drill Press."

FREE
Workshop
Guide &
Catalog

BARRON TOOL CO. INC.
364 Architects Bldg., Detroit 1, Mich.

SLIGHT IMPERFECTIONS

GUARANTEED OPTICALLY, MECHANICALLY PERFECT—our fall inventory has shown that we have on hand a fairly large number of our nationally sold and advertised microscopes which did not pass inspection. These imperfections are such things as finish defects, small pit in one of the frame castings, etc. All imperfect lenses or focusing mechanism parts are replaced and made perfect. We extend our regular 10-day money-back guarantee to all these instruments from the standpoint of perfect function and use.

Model 635
150-300-600 POWER
REG. \$2995
\$47 ON HAND AT
\$1995

each postpaid
This is the most popular all-around instrument in the country capable of 400 power. Used universally by schools, colleges, biologists and hobbyists. Additional eyepieces are available. See accompanying catalog.
(Some equipped with 13X eyepiece.)



Model 300P
100-200-300 POWER
REG. \$995
\$52 ON HAND AT
\$695

each postpaid
This is the most popular microscope ever made. Used in many schools for far teaching elementary biology. Sold in department stores all over the country. Triple objective, excellent focusing.



Model 800
20-600 POWER
REG. \$3995
161 ON HAND AT
\$2995

each postpaid
Purchase price above includes 12X eyepiece, 12, 12X, 20X & 40X objectives. See accompanying catalog for additional eyepieces. Achromatic condenser. Iris. Promote illumination (swivel head). Standard optics throughout. A handsome professional instrument.



Model 300PL
70-100-200-300 POWER
REGULARLY \$1695
209 ON HAND AT
\$995

each postpaid
This is the first quadruple turret hobby microscope ever made. All modern features, inclined eyepiece, "L" design.



CABINETS

All microscopes shown are shipped insured in their original fitted hardwood cabinets.



MICRO-ANIMAL LIFE

View with the most inexpensive instrument shown you can see and study microscopic animal life in a drop of stagnant water—such as the Volvox (Goby Animal).



the AKRON AKRON BLDG.
437D Sunset Blvd. Los Angeles 27, Calif.

EXECUTIVE INTERCOM SYSTEM

IMMEDIATE SHIPMENT

\$1995 postpaid

TWO ULTRA-MODERN FRENCH PHONES with desk cradles. An Akron country wide exclusive, the greatest intercom value ever offered anywhere! Handmade contemporary design. Solid Helium construction. Built-in double buzzer system. Operated anywhere with ordinary flashlight batteries (two included in each cradle). EXCELLENT VOLUME, FIDELITY, RANGE, CLARITY.



Use intercom, store-charge, home-garage, outside, inside. Black satin finish. 2 phones and cradles, 4 batteries inc., postpaid \$1995. Double wire, postpaid 4¢ per foot.

SEND CHECK OR MONEY ORDER to deposit on COD. Calif. resid. add 2% state tax. Return any item within 10 days for full refund. Items manufactured to our rigid specifications by selected Japanese firms. Electronics are standard U.S. manufacture.

MECHANICAL STAGES

Mechanical stages are \$14.85 extra (our standard price) and are available easy where shown on instruments above. Your instrument will be equipped with standard clip side holders if mechanical stage is not ordered. A few blank slides are included with each instrument.



FREE WITH ORDER

Our big 48 Pg. catalog of microscopes from \$95 to \$315, including accessories, telescopes, binoculars. Plus extra micro-manual that tells how to use. Both included free with any order or mailed for 25¢ postage & handling.

CUT-TO-FIT HOMES CUT BUILDING COSTS

CHOICE OF 57 DESIGNS

ORDER NOW

SAVE UP TO 1/3



Build your own home and save the builders' profit—plus savings in lumber and labor with Sterling Ready-Cut-Homes. Anyone can assemble with simple, easy to follow plans furnished. Every house complete with all lumber, roofing, nails, glass, hardware, paint, doors and windows marked ready to erect. Freight paid. Complete building plans ready for filing at low cost. Sold separately if desired. Write today!

PRICED FROM \$2150 up
Five Easy Payment Plans

Send 25¢ for NEW COLOR CATALOG

INTERNATIONAL MILL AND TIMBER CO.
DEPT. PM-104 BAY CITY, MICHIGAN

FULLY ASSEMBLED REAL 1/7 H.P. DIESEL ENGINE Over 100,000 sold at higher price. Not a Toy!

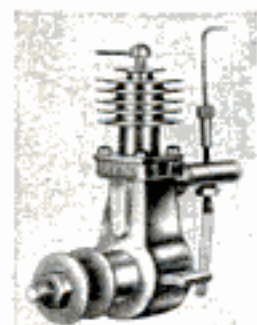

DEEZEL is a perfect power plant for planes, boats, race cars and experiments. (Runs at 7500 R.P.M. Produces 1/7 HP. Weighs only 5 oz.)

DEEZEL is an ultra precision engine as carefully machine-tooled as Giant army engines. Cylinder is honed to .0001 inch and hand fitted to its individual pistons.

DEEZEL is compact, rugged, streamlined. Starts quickly. Simple to install. You get it fully assembled.

DEEZEL is test run at the factory to assure perfection. Operating instructions included.

Send \$1.95 plus 5¢ postage today.

NOW
\$195
Plus 5¢
Postage

OUR 773rd ADVERTISEMENT

GOTHAM HOBBY CORP., DEPT P, 107 East 126 St., New York 35, N. Y.

The New Improved PLANACENTRIC
5-in-1 HOME WORKSHOP **\$89.95**
 with 8-Inch Tilt Arbor Saw and Tilt Arbor Sander

Save \$70
 and even MORE!

Vertical Drill Press always in position — ready for instant use!

Budget Terms

Single Tool Ease of Operation! No Lift! No Strain! No Bother!

The only one on the market with all these features for only \$89.95! 8" tilt arbor saw and sander, vertical and horizontal drill presses, industrial type lathe. Planacentric Home Workshop rips, crosscuts, miters, dados, bevels, drills, countersinks, sands, planes, routs, turns wood and plastics, grinds, polishes, does every job in the woodworker's dictionary. Heavy construction, professional quality, steel and cast iron parts, precision performance.

WRITE TODAY FOR FULL DETAILS!

Yoland Precision Tool Co., Dept. PM104, 20 Boylston St., Boston, Mass.

FILE SAWS FOR PROFIT!

BeMaCo Rapid Saw Filer
MAKES SAW FILING EASY. Opens the door to extra profits. A power driven filer that takes the work out of saw filing. Anyone can operate it. Gives full control to the operator. Priced Right. Write for literature today!

BeMaCo Automatic Saw Set — Uniformly sets 400 teeth per minute on hand or band saws. Perfect hammer and anvil action. Acclaimed by saw shops across the country.

BEAVER MFG. CO.
 Saw Machine Div. 12-C
 800 S. ISIS AVE. • INGLEWOOD, CALIF.

START EARNING TODAY!

WELD BRAZE
SOLDER CUT

4WAY
ONLY \$14.75
 f.o.b. factory

WELDER
 Complete with Twin Carbon Arc Torch and accessories... to handle all metal-craft work.

Acclaimed by thousands of Homeowners, Mechanics and Hobbyists as the welder of 1001 uses. Easily operated from properly wired 110 volt AC or DC line. The ideal gift with a life-long use... Order today on 10 day money back guarantee.

FOUR-WAY WELDER CO., Dept. F2-K
 1810 S. Federal St. • Chicago 16, Ill.

ALL INDUSTRIAL AND AUTOMOTIVE BEARINGS

BIG SAVINGS! Make profits on repairing autos, motors, machine tools, tractors, mowers or machines and power equipment **FOR YOURSELF AND OTHERS!** For replacement give bearing number needed. All A.B.E.C. tolerances available. For new applications give shaft OD, housing ID, bearing width, load and speed. C.O.D. shipment. **FREE technical advice.**

BIRLAI COMPANY, Dept. A-10
 524 W. Burlington St. Milwaukee 12, Wis.

BATTERIES! — START

— a factory at home and re-cast junk batteries into new; latest achievement. We supply complete instructions and everything needed. Large daily profits!

BATTERY LABORATORIES, Dept. PM, Minneapolis 4, Minn.

Also Eshelman **SPORT CARS** **LOWEST PRICE** 70 Miles Per Gal. Holds 1 Adult Free Literature

ESHelman FOR **Better LAWNS And GARDENS**

Women Can Operate It. Free Catalog. Write **ESHelman, Dept. R-510**
 109 Light St., Balto. 2, Md.
 333 N. Michigan Ave., Chicago - 1, Ill.
 7070 Hollywood Blvd., Los Angeles 28, Cal.

MAKES PLOWS CULTIVATES HARROWS HAULS SPRAYS SAWS DOZER MOWS CUTS ROLLS TILLS SNOW PLOW

Also **WALKING TRACTORS** **\$69** 1 to 8 H.P.

ARMSTRONG
Drop Forged "C" — CLAMPS

Buy once, for life. These famous drop-forged, heat treated clamps will not creep, spring, spread or break. Screws have close fitting smooth operating threads. Available in heavy duty, medium service, extra deep throat and welding types. Recognized throughout industry as the very finest.

Write for catalog.
ARMSTRONG BROS. TOOL CO.
 "The Tool Holder People"
 5268 W. Armstrong Ave., Chicago 38, U.S.A.

The Chief **WORK BENCH**
Built to Last a Lifetime!

With Bottom Shelf and 18" Sq. Drawer. 2"x6", Solid Plank, Grooved and Dovetailed Top and 1"x8" Back Rail, Shellacked to a Smooth, Satiny Finish.

MOHAWK LUMBER CO. Dept. 33
 14525 W. Chicago Blvd. Detroit 27, Mich.
 Enclosed Check Money Order for \$.....
 Ship..... **CHIEF WORK BENCHES** at
 Quantity \$19.95 each, F.O.B. Detroit, Mich.
 Send C.O.D., \$5 Deposit Enclosed.

NAME.....
 ADDRESS.....
 CITY..... STATE.....

6 Ft. Long • 34" High • 26" Deep. Shipped Knock-down, with Bolts, Nuts and Screws and ABC Chart for Quick, Simple Assembly.

Prompt Delivery
MOHAWK LUMBER CO.
 14525 W. Chicago Boulevard
 DETROIT 27, MICHIGAN

\$19.95
 F.O.B. DETROIT

Send Check or Money Order, or Will Ship C. O. D. (\$5 Deposit)

BUY DIRECT

GIANT 2000-2500 WATT PLANT

110-120 v. 60 cyc. AC. Absolutely the best made — exclusively dynamically balanced armature; heavy windings developing up to 5000 watt overload for motor starting. Skid mounted — portable. Powered by an easy starting Briggs or Wisconsin 6 HP engine—complete with all accessories; engine easily disconnected for other uses. Big outlet box, voltmeter, no wiring necessary. Ample current for all purposes. Factory warranty. (Item 31) Wt. 210 lb. Reg. price \$585. Special at..... **\$299.50**
Same plant with electric self starter (Item 31A)..... **\$359.50**
Generator only and control box..... **\$169.50**
DUAL VOLTAGE 110-220 available on any of above models for \$28.00 additional.
3000-3500 WATT PLANT (Item 198) 110-220 v. 60 cyc. AC Belt Drive, Wis. engine Push Button Start. Wt. 370 lbs. **\$399.50**
Heavy duty..... **\$239.50**
GENERATOR ONLY for belt drive..... **\$239.50**



(Item 31)

get MASTER MECHANIC'S BEDROCK FACTORY PRICES

PORTABLE LIGHT PLANTS

Ideal for your camp, cottage, trailer or boat!

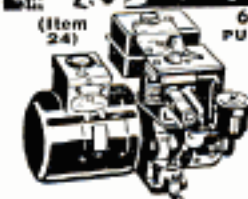

(Item 24)

600-700 WATTS PUSH BUTTON START

115 v. 60 cyc. AC. Powered by a rugged 2 HP easy starting Briggs engine. No wiring necessary; just plug in and operate. Plenty of current for any oil burner, freezer, brooder, emergency lights, etc. which require

up to 700 watts. Ideal for television and radios. Complete with Voltmeter and built-in winding to charge 6 v. auto batteries. (Item 24) Wt. 75 lbs. Easily fits in car trunk. Be prepared if storm knocks out..... **\$143.50**
power lines. Reg. \$275 value.....

1000-1200 Watt Plant (Item 45) same as Item 24 but larger generator and engine **\$199.50** with 50% greater output.....
LITTLE GIANT—350 WATT (Item 273) 115 v. DC 1 1/2 hp. Briggs engine. Perfect for lights, radios, chain saws and power tools. Wt. 65 lbs. **\$99.75**

PORTO-POWER Plant 115/130 v. 60 cyc. AC. Push button start. Powered by a 4.5 HP Briggs engine. Combines compactness and easy portability with higher output for handling heavier starting loads. Ideal for operating oil burners, sump pumps, freezers, television, lights, communication systems, etc. Perfect for contractor's power tools. (Item 20). Wt. 146 lbs. **\$279.50**
Factory Special Price.....



(Item 20)

MASTER-LITE 2500 Watt Plant 110/120 v. 60 cyc. AC. A powerful plant, ruggedly constructed and yet designed for easy portability. Can be started by rope or built-in 12 v. electric push button starter. Built-in winding to charge battery. Powered by a big 5.10 HP Briggs engine, complete with all accessories. Includes control box, voltmeter, and handy plug-in power receptacle. An ideal plant for permanent or stand-by service. Wt. 225 lb. Reg. price \$645.00 **\$329.50** (Item 21) Factory Price.....
3500 Watt Plant Push Button Start (Item 23) 115 v. 60 cyc. AC. Similar to above, but larger and 33% more capacity. Wt. 270 lbs. Reg. \$700. Factory Price..... **\$379.50**
We make fully automatic controls to operate any of the above light plants. Write for details. We make all sizes up to 25,000 Watts.

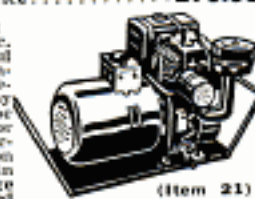

(Item 21)

LESS THAN WHOLESALE

DIESEL LIGHT PLANT

(Item 1660) Diesel Master—11-12 kw. 115/230 v. AC single or 3 phase. 1800 rpm direct connected. Electric Self-starting. Engineered for permanent power where continuous low-cost, heavy duty service is important. Wt. 1350 lb. Reg. list \$3650.00. Factory price..... **\$1895.00**

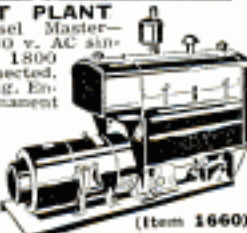

(Item 1660)

GAS DRIVEN PLANT, 10-11 kw. 115-230 v. 60 cyc. AC. single or 3 phase, powered by 4 cylinder Wisconsin air cooled engine. Belt driven. Simple, reliable, 3 V-belt drive mounted on rugged steel skid. (Item 217) (with crank start) **\$1075.00**
Wt. 300 lb. Factory price..... **\$1145.00**
Same plant with self-starter.....

HEATING & VENTILATING FAN

(Item 10) Easy installed in furnace pipes. Forces even heat to all rooms. Over range removes kitchen smoke and odors. Powerful, continuous duty motor. 110-120 v. AC. Mount in wall or ceiling to ventilate any area. Quiet, super-efficient fan moves huge volume of air. (400 to 600 CFM).
8" Fan, wt. 5 lb. **\$6.85**
9" Fan, wt. 6 lb. **\$7.85**
10" Fan, wt. 7 lb. **\$8.85**
12" Fan, wt. 8 lb. **\$9.85**
HEAVY DUTY FAN. Semi-enclosed motor, suitable for spray booths, restaurant exhausts, poultry houses, etc. 10" Fan, wt. 8 lbs. (Item 10E)..... **\$11.95**
12" Fan, wt. 10 lbs. (Item 10D)..... **\$12.95**



EXTENSION CORD

Very flexible and tough; Neoprene. Ideal for lawn mowers, hedge trimmers and power tools. U.L. approved. Complete with heavy rubber plug and outlet. 40 ft. cord (Item 17A) Wt. 2 1/2 lbs. regularly \$4.95—SPECIAL... **\$2.95**
100 ft. combination (2-40 ft. and 1-20 ft.) Item 17N. factory price... **\$6.45**
NEOPRENE CABLE 2-1/2-2 (Item 185) Heavy duty, very flexible, 20 year quality. Wt. 9 lbs. 100 ft. Complete with rubber plug and outlet. A terrific buy at only..... **\$8.95**
NO. 12-2 POWER CABLE. Very flexible rubber covered, special outside shield for grounding power tools, etc. 50 ft. (Item 199) wt. 8 lbs. \$6.95. 100 ft. (Item 200)..... **\$12.95**



9 TON HYDRAULIC PRESS

A tremendously powerful hydraulic press, capable of exerting 18,000 lbs. pressure. Pays for itself many times over—straightening bent connecting rods, king pins, crankshafts, axles, link pins and bars—or pushing out frozen bearings and bushings. Developed pressure under precise control and visible at all times on accurate gauge. Complete with both large and small anvils and jigs to straighten any kind of curve or bend. (Item 464) Wt. 110 lb. Actual list price \$365. Our special close-out price..... **\$69.50**



MASTER SHOP COMPRESSOR

Big and rugged. This stationary compressor provides 8 c.f.m.—plenty of air for industrial uses, powered by heavy duty repulsion induction 3/4 HP, 115/230 v. motor. Factory type twin cylinder compressor designed for continuous operation. Mounted on heavy 22 gal. steel tank. Complete with unloader type automatic switch, pressure relief valve, type valve, gauge, shut-off valve, and 20 ft. heavy duty air hose. (Item 209B) **\$174.50**
Regular retail \$319.50. Factory price.....



JET FLOW BLOWER

Tremendous air movement (1800 CFM) and quiet operation make this double inlet 10" turbine blower unbeatable for heating, cooling, drying and air conditioning. Ideal for attic or barn ventilation, converting gravity heating to forced air; spray booth exhausts, etc. Operates with any 1/4, 1/2 or 3/4 HP motor. Over-sized, long life bearings. Includes variable speed motor pulley and belt. Dimensions 19" h x 8" x 16 1/2". Outlet opening 13" x 11 3/4". Wt. 45 lbs. Item 245. Reg. \$54.50. **\$27.50**
Factory Special.....
HEAVY DUTY 1/4 HP motor for above **\$16.95**
12" TURBINE BLOWER similar to above, but larger with 2400 CFM capacity. Wt. 65 lbs. (Item 245A) Reg. \$70.00. Factory Spec. **\$34.50**



HI-FLO Centrifugal PUMP

Completely self-priming! No foot valve required. Tremendous capacity—100 gal. per min. 1" Special impeller enables pump to handle muddy or sandy water. Simple to operate—simply start engine and watch the water go. Powered by a rugged, easy-starting 2 HP Briggs engine. Pre-lubricated sealed bearings for years of heavy low-cost service. Big 1 1/2" Model. Item 302. Wt. 70 lbs. **\$134.50**
Factory price.....
2" Model (150 gal. per min.) with 2 1/2 HP engine. Item 302A. 90 lbs. Fact. Spec. **\$154.50**



52 pc. SOCKET SET

Highest quality, guaranteed non-breakable sockets made by Husky. Beautifully matched chrome finish alloy absolutely the best. Contains a complete set of 22 sockets in 1/2" drive, 3/4" drive and 1 1/4" drive, plus all necessary extensions, handles, speeders, reversible ratchets, etc.; all uncond. guaranteed against breakage. A beautiful set of tools that will handle any job in a big doghouse steel box. Wt. 17 lbs. (Item 25) **\$27.95**
List price \$42.90. Factory special.....

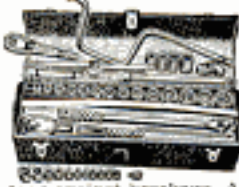

44 PC. SOCKET SET

(Item 306) Same unconditionally guaranteed, non-breakable sockets as above. Complete range of 21 sockets from 1/4" thru 7/16" (1/4" drive) & 7/16" thru 1-1/16" (3/4" drive). Two extensions, reversible 1/2" ratchet, 3 drive punches, sliding "T" head, all angle coupling, 1/2" speeder, 1/2" breaker, 5 pc. high chrome alloy combination wrench set and 8 pc. offset wrench set in big doghouse tool box with ample room for other tools. **\$21.95**
Reg. \$49.50. Wt. 16 lb.

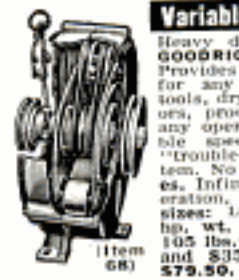

JET STEAM MASTER

Now, a new super-efficient portable steam generator that provides live steam at 100 lbs. pressure in 60 seconds from a cold start! The first quality steam blower ever offered at this low price. Instantly cleans, sticky grease, dirt, rust, old paint, etc. off motors—farm implements and road machinery. Pays for itself in a few weeks. Sterilizes as it cleans — milk equipment, etc. Fully automatic—oil fired with built-in water circulating pump. Draws water from faucet or bucket. Simple and safe: anyone can use it—built-in safety valve. New triple efficiency jet steam gun automatically mixes in soap or detergent if desired. Wt. 250 lbs. Item 463. Special **\$298.00**
Factory Price.....



MASTER DC ARC WELDERS

Now! a portable, rugged, industrial type welder with terrific performance, yet at a price hundreds of dollars less than you'd expect. Senior model made for years of trouble-free, continuous service. High capacity DC welding unit enables you to tackle any job with confidence—easily welds anything up to 2" plate using from 1/16" to 1/4" rods. Built-in stabilizer and cooling system makes arc easy to strike and hold. Dual control rheostat provides low heat soldering, brazing and welding from 30 to 300 amps. Complete with instructions, guarantee and triple V-belt or flat pulley. You can pay more, but you can't buy a better welder.
WELDER ONLY—DUAL CONTROL MODEL. Same as above, but drive with rear tractor, jeep or gas engine of 14 HP or more. (Item 280) **\$119.50**
30.1 Wt. 110 lbs. \$49 value.....
WELDER ONLY—STANDARD MODEL. Same as above but with single rheostat for heavy metal welding only. (Item 38.) **\$99.75**
Wt. 110 lbs. \$400 value. Special.....
COMPLETE POWER MASTER (Illustrated above) powered by a 14 HP, air cooled Wisconsin engine. Wt. 480 lbs. (Item 280) Compares with welder costing \$1200. **\$399.50**
Special for October only.....
WELDING KIT. Two 10 ft. leads, welding helmet, electrode holder, ground clamp. Sold only with welder..... **\$10.50**

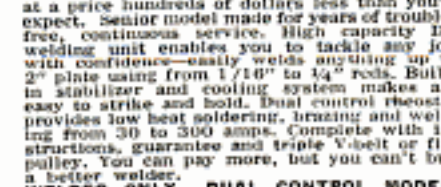

(Item 280)

Send check or M.O. Prices f.o.b. Factory. 10 day Money back guarantee. SEND 10c for... **BIG 1955 Catalog**
MASTER MECHANIC MFG. CO., DEPT. 72M Burlington, Wis.

LONG-PLAYING 33 1/3 R.P.M. HIGH-FIDELITY

\$1.00

8 MASTERPIECES

NOT \$1.00 EACH!—BUT \$1.00 FOR ALL EIGHT!
COMPLETE TO THE LAST NOTE!

Long
Playing



No Strings Attached!

Without any obligation to ever buy another record from us — now or later—you can now obtain all the advantages of trial membership.

NOW YOU can get a real start on a complete record collection. You get ALL EIGHT masterpieces—complete to the last note—for only \$1.00. NOT \$1 each, but \$1 for ALL EIGHT!

Of course, this price bears no relation to the value of the recordings. Even for 20 times that, you could not buy these masterpieces in recordings of equal quality.

We were FORCED to make this "give-away" offer . . . for only by putting our recordings in your hands can we convince you how extraordinary their tonal quality is. Performed by internationally-renowned orchestras, conductors, and soloists. Custom-pressed on the purest vinyl plastic. Reproduced with a fidelity of tone which encompasses the entire range of human hearing . . . 50 to 15,000 cycles!

How Club Operates

As a trial member, you are not obligated to ever buy another record from us. You do, however, have the right to try—free of charge—any of the Society's monthly selections which interest you. You receive prior notice of these. You pay nothing in advance. And you are not obligated to keep those you try . . . even after you have played them and read the interesting music notes which accompany each selection. You pay only for those which—after having tried them—you decide you really want to own. And for these, you pay only the low member's price of \$1.50 per long-playing disc, embodying on the average about 40 minutes of music by the great masters. A saving of about 2/3 off the usual retail price!

Mail Coupon Now

We obviously cannot keep "handing out" such magnificent long-playing recordings indefinitely. Production capacity limits the membership rolls; once filled the offer has to be withdrawn. So avoid disappointment. Rush coupon with a dollar today. *The Musical Masterpiece Society, Inc., Dept. 7010, 43 West 61st Street, New York 23, N. Y.*

SCHUBERT

Symphony No. 8 (The "Unfinished"),
Zurich Tonhalle Orch.,
Otto Ackermann, Conducting

BEETHOVEN

The Ruins of Athens (March and Choir),
Netherlands Philharmonic Choir and Orch.,
Walter Goehr, Conducting

BRAHMS

Academic Festival Overture,
Utrecht Symphony,
Paul Hupperts, Conducting

MOZART

Piano Concerto in E Flat, K 107
Artur Balsam, piano,
Winterthur Symphony Orch.,
Otto Ackermann, Conducting

BACH

Tocatta and Fugue in D Minor,
A. Schreiner; Organ of the Tabernacle,
Salt Lake City

WAGNER

Die Meistersinger, Prelude, Act 1,
Zurich Tonhalle Orch.,
Otto Ackermann, Conducting

DUKAS

Sorcerer's Apprentice,
Utrecht Symphony,
Paul Hupperts, Conducting

MOUSSORGSKY

Night on Bald Mountain,
Netherlands Philharmonic,
Walter Goehr, Conducting

FREE

Mail coupon. Get FREE fascinating brochure by Olin Downes. Valuable musical annotations and program notes come free of charge with every selection.



The Musical Masterpiece Society, Inc., Dept. 7010,
43 West 61st Street, New York 23, N. Y.

ALL 8 MASTERPIECES — \$1.00

Here is my dollar in complete payment; please send me ALL 8 of the masterpieces listed above and enroll me as a trial member. Send me notice of future selections which I may try for 5 days without cost or obligation. For those future selections I decide to keep after I have tried them I will pay only the special member's price of \$1.50 each, plus few cents shipping. I may cancel my trial membership at any time.

Name.....

Address.....

City..... State..... 7010

In Canada, address: 686 Bathurst St., Toronto 4, Ont.

FROM THIS

TO THIS



FOR LESS THAN \$6.00

with **FORMICA** +
and simple hand tools



Here's how you can take those scratched, burned and stained occasional tables and make them look like new — to stay. Now you can select the wood grain of your choice in the very same Formica used by professionals.

It's easy and it's fun to do-it-yourself in these 6 easy steps.



1. Sand off the old finish.



2. Mark the Formica sheet to size for the new top.



3. Saw Formica top side up with fine tooth saw.



4. Spread on Formica Contact Bond Cement with metal toothed spreader supplied with can.



5. Carefully align Formica sheet with edges of table and press down.



6. Roll with ordinary rolling pin and file edges.

Free! Send for illustrated folder containing complete instructions for Formica surfacing furniture and sink tops. Samples included.

Write **FORMICA**
4596 Spring Grove Ave.
Cincinnati 32, Ohio

In Canada: Arnold Hanfeld & Co. Ltd., Oakville, Ontario

DEMAND THIS CERTIFICATION

This mark certifies genuine
REMOVE WITH SOAP AND WATER

Seeing is believing. If this wash-off identification is not on the sheet, it's not Formica.



It's New... It's **DYNAMITE!**



-  **Lowers Every Hill**
-  **Shortens Every Road**
-  **Speeds Every Run**
-  **Out-earns Anything Known**

Stand up and cheer! REO's about to announce the most revolutionary thing that's ever happened to horsepower —REO's transformed it to raw, searing, surging concentrated dynamite. This sensational development brings you tomorrow's super-truck, today.

WATCH FOR THIS MIRACLE
OF MODERN HORSEPOWER...

Coming to Your
REO Dealer Soon!!!